

# Audio Control

Congratulations on your good taste in picking our equalizer over everyone else's.

Now it's our responsibility to show you how to use it. And that's a challenging job.

Because there are those of you who are virtual Electrical Engineers and there are also those of you who have bought this as part of your first real system and who don't know a phono jack from a Fig Newton.

So bear with us as we try to mix the basics with a little theory. Because a little theory helps when dealing with tone and equalization. If our theory lectures seem a bit elementary, then write us and we'll lock equations with you EE types at twenty paces.

Follow this manual from page one on through and you won't go wrong.

**SEVERE WARNING: STOP. DO NOT  
PASS GO. DO NOT COLLECT \$200.  
DO NOT START FIDDLING WITH  
YOUR 520!!!!!!!!!!!!!!.**

We know you want to take your 520  
out and start messing with it.

But don't.

Fill out the warranty card. Steal a  
stamp. Mail the warranty card. File the  
warranty and receipt or saleslip.

NOW!!!!!!!!!! GET GOING. We'll wait. ....

Don't forget where you filed the  
warranty. We'll expect to get the detached,  
filled out card within ten days.

**Now** you can take the 520 out of  
the box.

**SECOND SEVERE WARNING:**

Don't chuck the box. Save it including  
the giant baggie the 520 came in.

You'll need it for mailing if anything  
goes wrong and it's very handy for moving  
when you get evicted because you couldn't  
pay the rent since you spent your money  
on an outrageous system and the low bass  
was bothering the little old lady upstairs.

ONE COSMETIC HINT, TOO. The 520's  
unique electrostatically-deposited grey paint  
job shows fingerprints and general people-  
grease easily. If you can't resist eating potato  
chips and then fingering your 520, and the  
fingerprints offend you, simply clean the case  
with a sponge, soap and warm water. Take  
extreme care to keep the water out of the  
innards and always unplug the 520 before  
washing its cover.

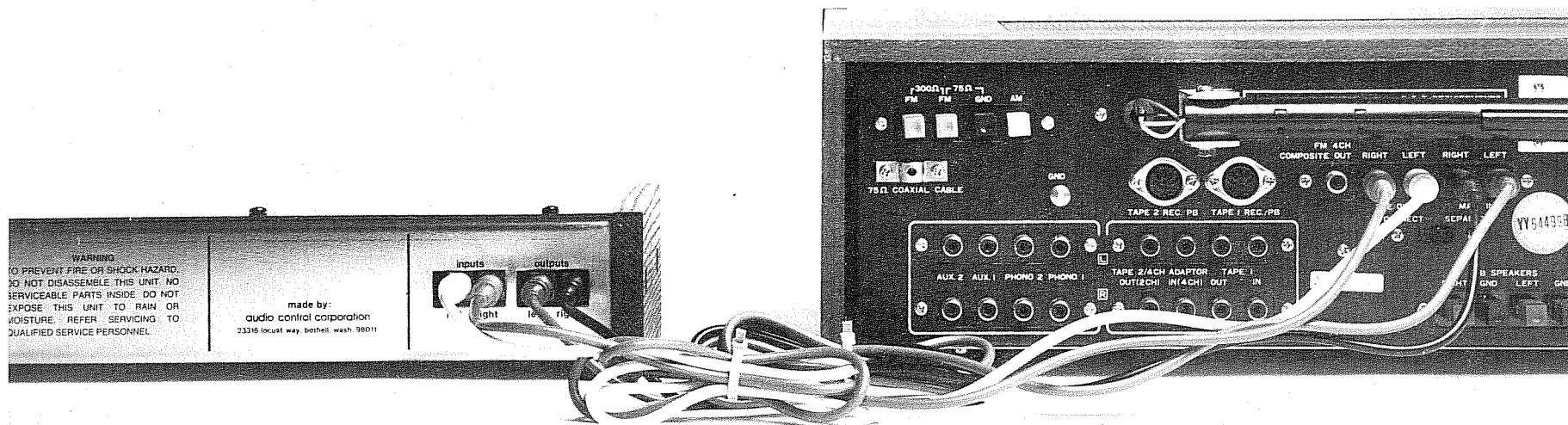

### IT'S DECISION TIME, FOLKS.

There are two ways to hook up your 520.

Each will achieve different results, so now is the time to take stock of what uses you wish to put the 520.

### THE MAINLINE METHOD.

This only works if there's something on the back of your receiver or integrated amp that looks like this. This is a hook-up between pre-amp and power amp.

A little creative fiddling around with two sets of phone plugs, you've got this...

That's what the big photo above is showing.

If you have a pre-amp and power amp rather than an integrated amp or receiver, simply connect the 520 in between the pre-amp and power amp, using one extra set of phono cables.

Now everything that goes through the pre-amp, that is records through the phono input, tape recorders, FM broadcasts... everything can be equalized by the 520.

It is, in effect, acting as a sophisticated set of tone controls just like the ones on your receiver, pre-amp or integrated amp.

Now proceed to the section marked HOW TO CREATE A SONIC ROOM, and consider yourself lucky we didn't try to get complicated like we're going to on the next page.

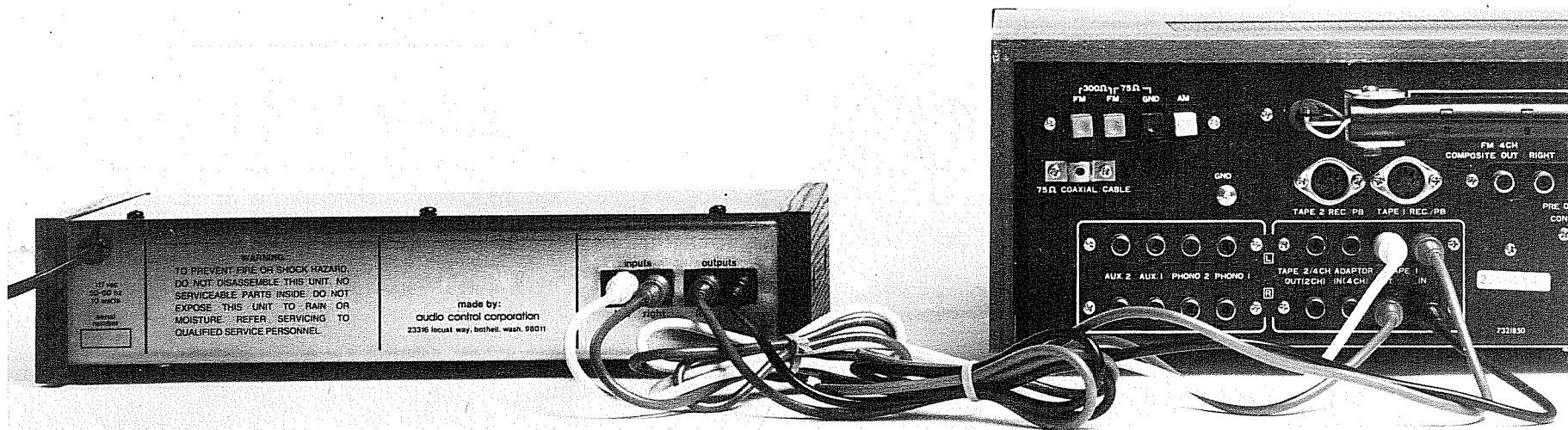

## HOOK-UP TWO: THE OUTBOARD GADGET SYSTEM.

If you wish to use the 520 to equalize tapes before recording or hook the 520 up as part of a noise-reduction system, or simply to be able to activate the 520 from your receiver or pre-amp switches, we suggest plugging it into the TAPE MONITOR circuit. This makes the 520 part of any number of gadgets you can activate without affecting the direct flow of impulses from source to speaker.

If you're not sure of what we're getting at, read the next four pages and take your choice.

In this hook-up, you place the 520 in the traditional "extra stuff" circuit (the tape monitor), where noise reduction systems such as the DBX 122 or Burwin, expanders and limiters like the DBX 118 or MXR compander, or esoteric gadgets like the new pop filters (which remove record noise, not Elton John).

As a matter of fact the 520 can be hooked up with any or all of the above.

If the 520 is your first "outboard gadget," hook it up as is shown in the big picture above.

If the 520 is part of a series of gadgets, like expanders or noise reduction equipment, put it LAST in the series, just before the return to the TAPE IN plug. This is so EQ changes don't trigger weird things in the expanders and other sensing circuitry found in outboard compressors and noise reduction systems.

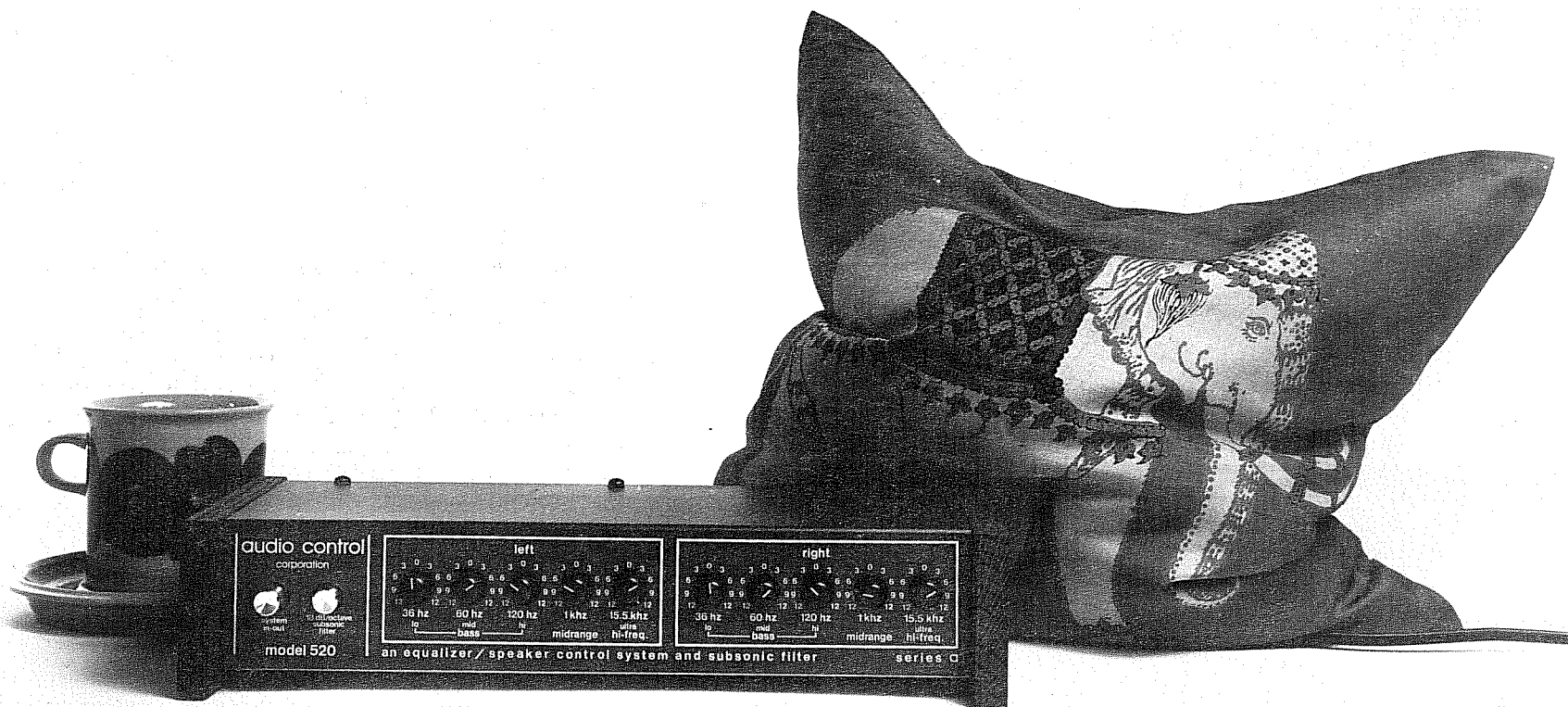

## HOW TO CREATE A SONIC ROOM.

The 520 can be used to make basic improvements in your listening room acoustics. More complex equalizers can do a more precise job (at a much higher cost), but the 520 can help reduce "boominess" or improve highs that have been absorbed. But first, plug the 520 into the wall socket.

We didn't mention that until now to keep the self-styled experts out there on their toes and to keep the neophyte from shorting anything out with misconnections. You can plug the 520 into an extension cord, since it draws very little current, directly into a wall socket, or into the switched or unswitched sockets on the back of your receiver or amp.

In any case, don't worry about leaving the 520 on all the time. It draws as little current as an electric clock.

### *The sound of a room.*

Sound doesn't just come out of your speakers and disappear into the woodwork. It bounces around. Some frequencies bounce better than others.

Very high frequencies, for example, are absorbed by carpets and drapes and upholstered furniture. Inversely, in a bare room with hardwood floor and plaster walls, the highs bounce around and seem magnified to your ears.

Low frequencies also tend to resonate (or bounce around rhythmically).

This is why large auditoriums and even larger living rooms are so "boomy." A certain frequency range is getting accentuated by continuing to bounce around. Not only does this make your ear think there is more of a certain frequency coming out of a speaker or off a record, it tends to muffle sounds because they're still bouncing around when other sounds are being made.

### *Start at the speakers.*

Where your speakers are and how they are set, can affect their sound long before you begin to adjust them with the 520. Boosting highs or lows by correctly positioning your speakers is a lot easier on your electronics than forcing them to pump out more of a frequency.

If you're getting too much bass; if the sound is boomy, get your speakers out of the corners of the room and up off the floor. Raising a speaker even 12" or moving it three feet out of a corner lowers bass.

More likely, you're not getting enough bass. Even though you bought the 520 to rectify that situation, first start by making sure your speakers are in corners and close to the floor. This is the best way to boost bass because it does not require more amplifier power. You can always add even more later.

If positioning doesn't help, use the 520. How that's done is covered in the next section where we treat its true function, getting more out of your speakers by acting as a tone control.

If your speakers don't have any knobs or switches on them, you can ignore this section. If they do, now's the time to set them right.

If your speakers have knobs, turn them all the way down. If there is a multi-position switch set it to "off". Now put your ear between the woofer and midrange\* and turn the midrange knob until the sound seems to blend.

If your speakers have switches, use the same procedure, clicking the positions as you go from least to most treble and midrange.

\*A footnote for those who don't know a woofer from a tweeter. Take off your grill cloth. Count the speakers. If there are two, the big one is the woofer and the little one is the tweeter. If there are three, the medium-sized one is the midrange.

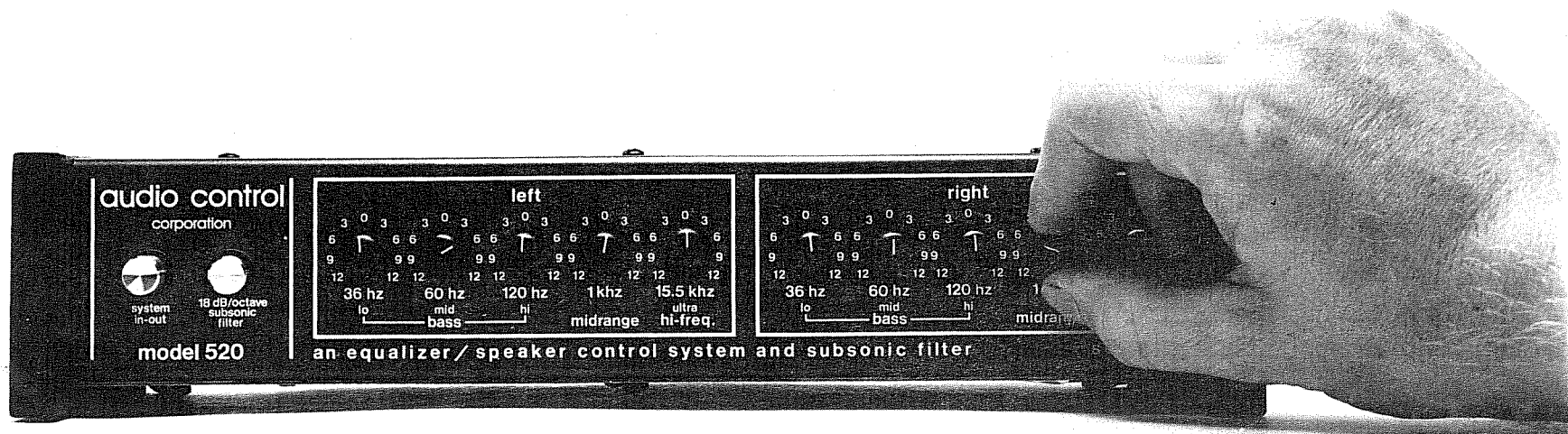

## THE 520 AS A VERY GLORIFIED TONE CONTROL.

or

## HOW TO MAKE YOUR SPEAKERS SPEAK WITHOUT AN ACCENT.

The 520 primary function is as a more precise tone control. The bass, treble controls on your amp or receiver do somewhat the same thing, but very clumsily.

Say you're listening to some music and you want more low bass because the sound looks somewhat like this.

If you turn up the bass control on your receiver, this happens. TILT! You not only

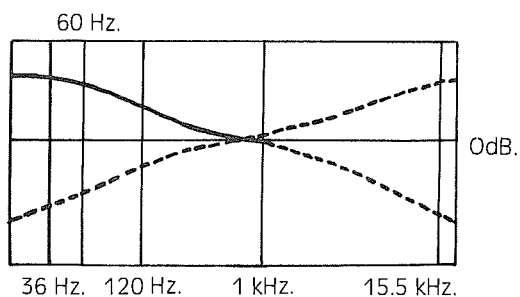

A typical tone control.

boost the low bass, you affect the whole bottom end. That's because the bass and treble controls are shelving-types that change very broad sections of the audio spectrum.

With the 520, you can pick out the range you want, in our hypothetical case, 60 Hz, and boost just it.



### *Why speakers have speech impediments.*

First, many speaker elements (the woofers, tweeters and midranges) aren't as good as they could be to start with. They may have peaks within their frequency area instead of putting out all frequencies at the same sound level, or they may not be able to reproduce their whole assigned tonal range as well as they could.

Their magnet size may be inadequate so that no matter how much power you put into them, they can't react well. Or they may not have enough cone travel to move enough air to create that low bass response.

They might just be really crummy in all respects, too.

Then there's how you hook speaker elements together. The crossover, which divides up the frequency spectrum and assigns it to the various drivers might be 1) poorly designed, 2) made with cheap components which induce distortion or don't properly divide the frequencies or 3) be simply non-existent with a simple blocking capacitor protecting the tweeter but letting all frequencies into the woofer.

The enclosure, too, can be less than optimal. Its composition, volume, inside damping materials and actual proportions all add or subtract to a speaker's performance.

The engineers who design for the consumer market have all sorts of these economic realities to deal with.

Even if you have well designed speakers with good drivers, there is only so much that can be done with speaker physics.

An outboard 520 equalizer that costs just over a hundred dollars can do a lot more than a hundred dollars worth of improvement on your speakers.

What we're saying is that most speakers can stand a little improvement—even the best of them. And that inexpensive speakers can stand A LOT of equalization.

The same goes for the treble end.

In the signal chain from phono cartridge to speakers, the speaker is the weakest link. Distortion that averages less than 1% in the cartridge, amp and pre-amp can be increased to as much as 30% in a bad speaker system. It's just a lot easier to design distortion-free, wide frequency range electronics than it is electro-mechanical speakers with magnets and cardboard cones and wire and surfaces that have to flex back and forth.

So unless you have speakers costing upwards of \$1,500 each (and even then sometimes), their sound can be improved with equalization.

There are a lot of reasons for this and they all basically center around the common inadequacies of most consumer speaker systems. (Obviously there has to be more to a \$1,500 speaker than a \$25 speaker system.)

For example, some horn speaker systems have a nasal character, which can be reduced by removing a few db of 1Khz sound. Some small bookshelf systems, particularly two-way systems have a muffled, distant character, also remedied with the 1k control. Just turn it up. You'll be amazed how vocals seem to "approach" you.

All of the above are only suggestions.

Since the 520 is a tone control, and since every one of you probably has a different idea what music should sound like, it's really up to you.

In general, we find 520 users boosting the 36 and 60 hz bass, cutting the bonky 120 hz bass, and boosting the 15.5hz range.

### Tracking the elusive super-low bass.

One area that REALLY can't be accentuated with a regular bass control is the area below 40hz. This is the gut-rocking visceral area of bass. The part that moves you and shakes you and kills your Boston ferns. The part of rock that stomps you and the part of classical that's rarely if ever heard: tympani, double basses and low organ pedal notes.

If you turn up your bass control, you not only get too much of the higher boomy bass, you get the inaudible portions of the lower frequency range boosted which increases those nefarious villains of the audio underworld, subsonics (covered on the next page.)

With the 520 a simple tweak of the knobs rocks your socks off.

It can help this bass problem by being more specific with the areas it boosts—as compared to a more generalized tone control. You really don't have to worry about 36hz as much as 60 and 120, since there are very little 36hz program sources. Just don't turn them ALL up to 10 db at once!

A word of warning, though. Increasing a signal 6 db at 36hz increases the demand for power on your speakers by 100%. Some amps and receivers just don't have the stamina to reproduce what you and the 520 would like to hear which can result in tweeter damaging clipping.

The proverbial Fletcher-Munson effect.

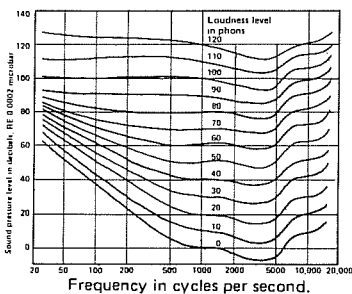

Equal loudness contours for pure tones by Fletcher and Munson. Taken from *Acoustics* by Leo Beranek, p. 399.

### Getting really high with the 520.

Most people don't know what they're missing in the truly high sound ranges. They think of tinniness and screeching.

Nonsense. That's the high midrange. True 15,000hz highs are the crispest most precisely defining edge of music and very pleasant indeed to the ear.

They're the sizzle of brush on cymbals, the sharp intake of breath in a singer, the sound of fingers on a guitar fretboard, the nuances of strings, the zing in bells and triangles.

Forgive us, we get rhapsodic on this subject.

Suffice to say, the 15.5Khz knob on the 520 is designed to improve this area. Give it a twiddle, you'll be surprised just how good your tired old speakers can sound when the dust gets shaken off the tweeters.

For those of us who are no longer tender teenagers, the 15.5K range has even more interest. This is where humans start losing their hearing first. *Everyone* above 30 has some high hearing loss, so you might consider turning this up as a matter of course if you're only young at heart.

### Arranging the midrange.

The character of music is greatly affected by the midrange. Here is where most vocals occur and much of our traditional instrumentation as well as rock sound.

Let us trot out yet another chart. This time the dreaded Fletcher-Munson Effect. What 'Ole Fletch and Muncie discovered was that your ears are more sensitive to mid-ranges than any other frequency. It is the range where we sense "presence" or distance. It is the range of human speech and most natural sounds.

As you can see by the chart, a little goes a long ways. This is the area of the sound spectrum that becomes unpleasant as music gets louder or annoying when not present. Exaggerations of midrange caused by speakers or deletions of midrange are very noticeable.

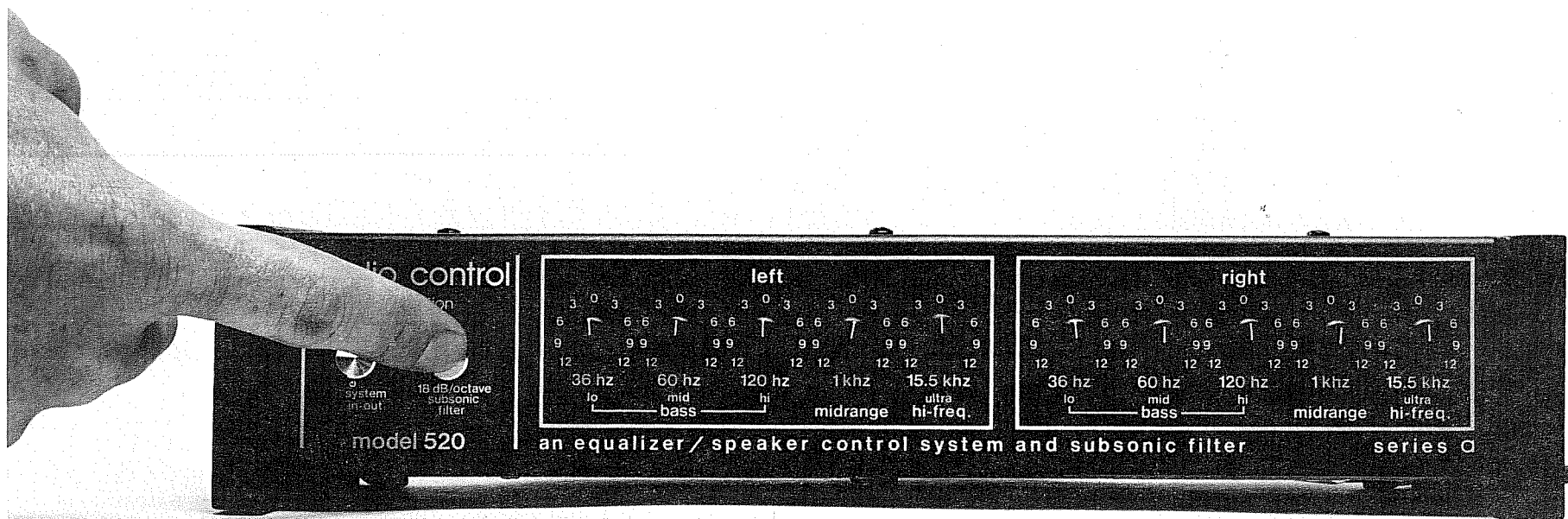

## GETTING RID OF INVISIBLE MONSTERS.

### Or YOU NEVER HAVE TO CLEAN YOUR SUBSONIC FILTER.

Subsonics are just what their name implies: sounds below the range of human hearing. You don't need them.

In fact you shouldn't have them.

Here's why.

Your speakers insist on trying to waste energy and motion reproducing them.

Warped records, turntable rumble, the thump made when a tonearm is lifted off the record, the interference between stations when dialing FM and the feedback caused by placing a turntable close to the speakers all can literally beat a woofer to death.

Amplified power is wasted and since the speaker is busy trying to reproduce sound you can't hear, it messes up audible sounds (intermodulation distortion), especially in a 2-way system where the woofer is also handling some of the midrange chores.

Reflex and vented speaker systems particularly are prone to this sort of potentially destructive woofer cone movement.

If you have such a system, ALWAYS leave the subsonic filter button on. To tell if your speaker system is vented, remove the grill cloth and look for a hole leading into the enclosure. If there is one and you can feel a motion of air when you play the system, you have a vented or reflex system, rather than an acoustic suspension, sealed box system.

The 520 uses a sophisticated 3-pole 18db/octave Butterworth filter to do away with subsonic interference for good and without any audible side effects. The bass response of your system will sound more solid and in most cases you can safely use a more powerful amplifier. Just press the button...not a bad deal!

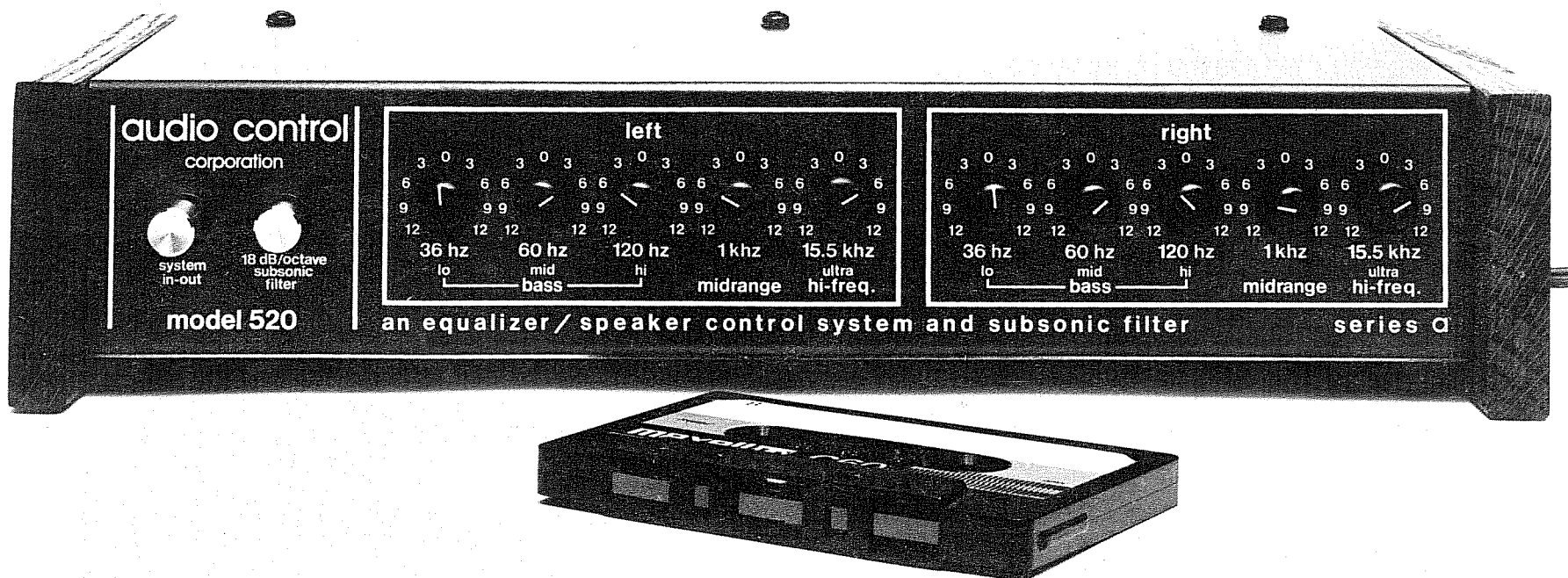

## HOW TO BE A HIP RECORDING ENGINEER WITH THE 520.

Or even a not-so-hip recording engineer.

In the studio, almost all signals receive some equalization before they're put on tape. There are several good reasons for equalizing as you record something, even if it's just off a record and onto a cassette.

The best reason is so any high-end boost can be inserted without also boosting residual tape noise, too.

For example, if you want more cymbals and ultra-highs on a certain record when you're transcribing it to cassette, doing it as you record it allows putting an already-boosted high end signal onto the cassette.

If you took the output of the cassette deck in playback and boosted it the same way, you would also boost tape hiss which is in the same frequency range.

One word of warning, though. EQing onto tape means forever, so to speak. That's the way it will sound time after time, so you'd better like it.

There is one area where equalization while taping is a must, though.

That's when you're making cassettes for your car system.

Unless Audio Control comes up with a mini-520 for cars, you're cursed with little or no control over tone. And in a sort of speaker situation (mostly midranges trying to reproduce frequencies they're not physically suited to reproduce) where equalization can really improve sound.

Hook up the 520 through your tape RECORD plugs.

To really customize a cassette to your car, you should try and do the equalization adjustments on the same speakers you're going to listen to the sound on. Bring them in the house if possible. If not run back out with the tape once in a while.

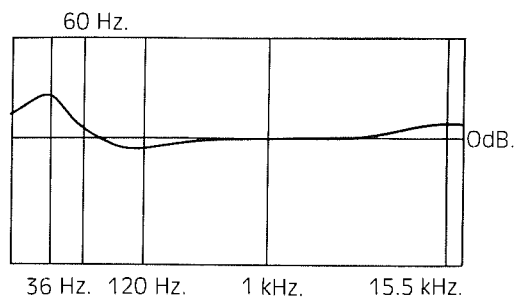

A typical 520 setting.

Boost the 36hz, reduce the 120 hz, leave the 1k alone or cut it a bit and maybe add a little something at 15.5k.

Also cut in the subsonic filter, since here's a classic case of needing all your speaker movement and amp power for the task of music reproduction.

The 520 can also be used in informal home recording circumstances to actually improve live recordings. You'll be amazed what a little boost in the 60-120hz does to a male voice, and what the 60 and 15.5k bands do to make an inexpensive acoustic guitar sound more like a \$5000 Martin by bringing out the rich sub-harmonics below 80 cycles that a good guitar has and a cheap one doesn't.

**WARNING: THE 520 IS NOT A PROFESSIONAL-TYPE EQUALIZER AND IS NOT INTENDED OR WARRANTED FOR SOUND REINFORCEMENT USE.** The recording equalization we're advocating is for modest, home recording of acoustic sources and re-equalization of records and tapes, only.

## How The 520 Works.

The following is a general description of the inside workings of the 520. The type of circuitry used is the same as the most recent very best and most expensive equalizers currently being made. All active circuitry (16 operational amplifiers) is contained within 4 micro circuits which are individually selected for low noise and distortion. These micro circuits are powered by an intentionally low power supply voltage of ( $\pm 15$ ) providing very high reliability.

The input signal which is derived from the input jack on the back of the unit first goes through an RF filter to minimize RF interference like cb's etc. Then into the first active stage which is a unity gain operational buffer amplifier which provides a high input impedance preventing any bizarre loading problems from occurring with the pre-amp/receiver being used, and a low output impedance with a high drive capability to properly drive the following stage which is an 18dB/octave Butterworth hi-pass (subsonic) filter. The Butterworth filter is switched in or out of the signal path at the next stage.

Here is the stage that is the heart of the entire circuit. This stage, in conjunction with the tuned circuits, provides the equalization capabilities, and the low impedance high drive capability output.

At the input of this stage is a switch that selects its input signal from either the output of the buffer amp or from the output of the Butterworth filter. Both inverting and non-inverting inputs of the operational amplifier are utilized forming a differential amplifier having inputs to allow the application of both signal and feedback.

The 10 rotary controls (5 per channel) are connected between the two differential amplifier inputs.

The wiper of each potentiometer is returned to ground through a resonant circuit which determines the frequency, bandwidth, and range of adjustment.

When a wiper is in the cut position, frequencies within the band of resonance are partially shunted through the resonant circuit to ground, thus reducing the signal at the input of the differential amplifier causing a cut in amplitude. When a wiper is adjusted in the boost position, the same

resonant circuit shunts some of the negative feedback within the resonant band to ground causing a boost in amplitude.

When the control is adjusted to the center, the effects of the resonant circuit are exactly nulled out resulting in a flat response.

The resonant circuit is made up of a resistance, a capacitance, and an inductance which is of the synthesized variety using op-amp technology to simulate the good properties of the traditionally used passive inductors (coils of wire etc.) but without any of the bad side effects like saturation induced distortion, hum pickup, weight and bulk caused mounting problems, and finally their cost. The synthesized inductor is what makes this product available at a reasonable cost.

The system in-out selector switch determines where the output jack will get its signal from. When the system is switched in the output jack is connected directly to the output of the EQ circuitry. When the system is switched out, the jack is connected directly to the input jack.

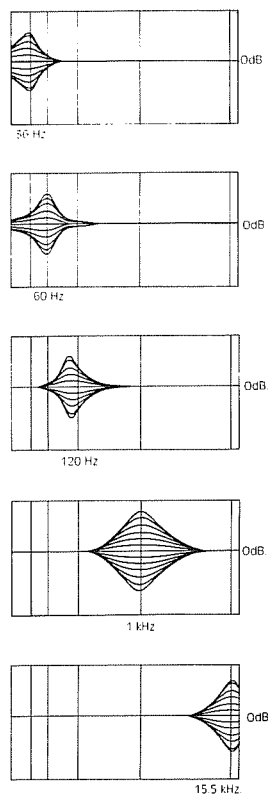

520 setting.

Combined 520 curves.

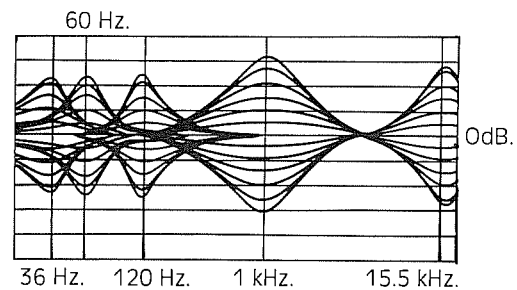

Maximum 520 curves.

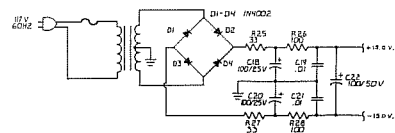
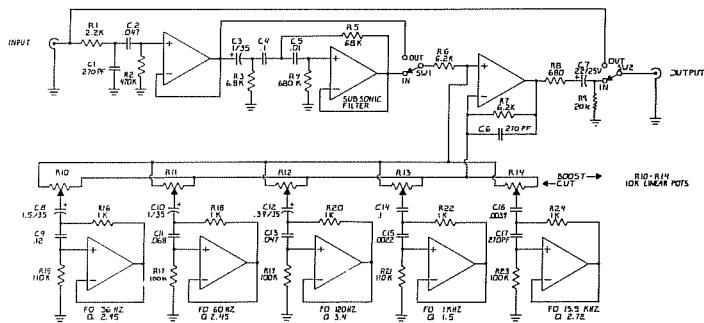
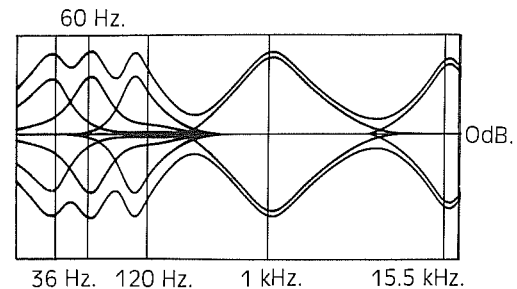

## 520 SPECIFICATIONS

### SUBSONIC FILTER ACTION.

|       |        |                      |
|-------|--------|----------------------|
| -0    | 40 Hz. | 18dB/octave @ 20 Hz. |
| -4    | 35     |                      |
| -1    | 30     |                      |
| -3    | 25     |                      |
| -6.5  | 20     |                      |
| -24   | 10     |                      |
| -43dB | 5      |                      |

### NOISE

All noise measurements @ 1 v. Input and 600 ohm source  
 20- 10KHz noise band width  
 96dB Below 2v. out.  
 90dB Below 1v. out.  
 Equivalent input noise 30 microvolts

### DISTORTION

Below .04% THD 20Hz-20KHz @ 1 v. output  
 Below .01% IMD SMPTE Method

### FREQUENCY RESPONSE

15 Hz to 30 KHz  $\pm 1$  db  
 8 Hz to 50 KHz  $\pm \frac{2}{3}$  db

**OUTPUTS**

Rated output 1 v. RMS  
Max output 7.5 v. RMS  
Output impedance 600 ohms (for use with any amp 600 ohms or higher)

**INPUTS**

Rated input 1 v. RMS  
Max input 7.5 v. RMS  
Input impedance 470 K ohms

**EQUALIZATION**

|                     |      |      |      |      |       |
|---------------------|------|------|------|------|-------|
| Band Centers        | 36   | 60   | 120  | 1K   | 15.5K |
| "Q"                 | 2.95 | 2.65 | 3.40 | 1.50 | 2.70  |
| Apprx octave widths | 1    | 1    | 1    | 2    | 1     |

**EQ RANGE**

±12-15dB depending on  
settings of adjacent controls

**WEIGHT**

2.5 lbs.

**DIMENSIONS**

H—2.6"  
W—12.3"  
D—5"



**AudioControl**