

AudioControl®

The DIRECTOR™ *Model 46*

Four Source, Six Zone
Audio Multi-Room System Controller



Installer's Manual

Software Version: 2.0_x

Last edit date: January 8, 1998

© 1995-98 by AudioControl, 22410 70th Ave W, Mountlake Terrace, WA 98043

The Director Model 46 is a trademark of AudioControl. All Rights reserved.

All other marks are trademarks of their respective companies.

Section 1	Introduction	
	System Features	1-1
Section 2	System Overview	
	Homeowner's view	2-1
	Installer's view	2-2
Section 3	Designing and Planning an Installation	
	Installation Considerations	3-1
	System Configurations	3-7
	Station Networks and Configurations	3-9
	Wiring	3-13
	Selecting Source Units	3-16
	Additional Equipment Requirements	
	Amplifiers	3-20
	Optional sources - Door Bell, Phone, etc.	3-21
	Using Two Directors	3-22
	Using the Director Model 46	
	with Other Home Automation Systems	3-23
Section 4	System Programming	
	What are Macros?	4-1
	Factory Default configuration?	4-1
	Connecting the Director to a Computer	4-2
	Menu Overview	4-3
	Saving Programming on a Computer	4-60
	Downloading Additional IR Codes	4-58
Section 5	Troubleshooting	
	Things to Look For	5-3
	Getting Help	5-13
Section 6	Warranty	
Section 7	Appendices	
	Appendix A - Specifications	7-1
	Appendix B - Architectural Specifications	7-2
	Appendix C - Connectors and Signal Information	7-3
	Appendix D - Software Revision History	7-6
	Appendix E - Current IR Control Codes Available	7-7
	Appendix F - Available wall station configurations	7-8
	Appendix G - Accessories	7-9
	Appendix H - Blank Programming Worksheets	7-11
	Appendix I - Macro Elements	7-27
	Appendix J - External Control Commands	7-38
	Appendix K - Front panel metalwork drawing	7-40
	Appendix L - Factory default configuration	7-42
Section 8	Index	

About this Manual

This manual describes the AudioControl Director Model 46. The manual is divided into several major sections.

Section 1 Introduction

Section 2 System Overview

Section 3 Designing and Planning an Installation

Section 4 System Programming

Section 5 Troubleshooting

Section 6 Warranty

Section 7 Appendices

Appendix A - Specifications

Appendix B - Architectural Specifications

Appendix C - Connectors and Signal Information

Appendix D - Software Revision History

Appendix E - Current IR Control Codes Available

Appendix F - Available wall station configurations

Appendix G - Accessories

Appendix H - Blank Programming Worksheets

Appendix I - External Control Commands

Appendix J - Front panel metalwork drawing

Appendix K - Factory default configuration

Section 8 Index

Notational Conventions

Within this manual, several different notation conventions are used to indicate various facets of the SA-3055's features.

SMALL CAPS Indicate a marked feature on the unit, like a control or a connector. They are also used within procedures to identify controls and switches by function.

Italics Are used for emphasis. Words printed in **boldface** and **boldface** convey more emphasis than those printed in *italics*.

Notes, Cautions, and Warnings

Some of the text in this manual is set apart by the headings: Note, Caution, or Warning.

These terms are used to denote varying degrees of awareness required by the user during installation, operation, or maintenance of the SA-3055.

NOTE conveys information that may be helpful to the user. A note is similar to an aside during a conversation.

CAUTION indicates a potential danger to the instrument.

WARNING indicates a potential hazard to the operator.

Introduction

Thank you for your selection of AudioControl's Director Model 46 as your multi-room audio control system. This unit is the result of many years of effort and collaboration between sound contractors like yourself and our engineers. We've tried to make it as reliable, versatile and easy to install as possible. We hope that you find it to be so.

Powerful

The Director Model 46 is the brains between the homeowner and their audio system. It allows simple one-button access to their favorite music. The powerful macro programming capabilities of the Director allows you to accommodate special customer features with any wall station. Reconfiguring the Director is also very simple to do when the homeowner finds out just how convenient this system is and wants you to come back to expand it.

Installation Tip:
If you have installed the Director Model 46 systems in the past, please check Appendix D - Software revision history and Appendix E - Current IR control codes available for any new features that may have been added since your last installation.

Simple To Operate

From the homeowner's perspective, the Director Model 46 control stations are attractive and provide an intuitive, easy-to-use interface. You will find that the vast majority of your customers will require a minimum of instruction on the operation of the system. Most of them won't even need an instruction manual.

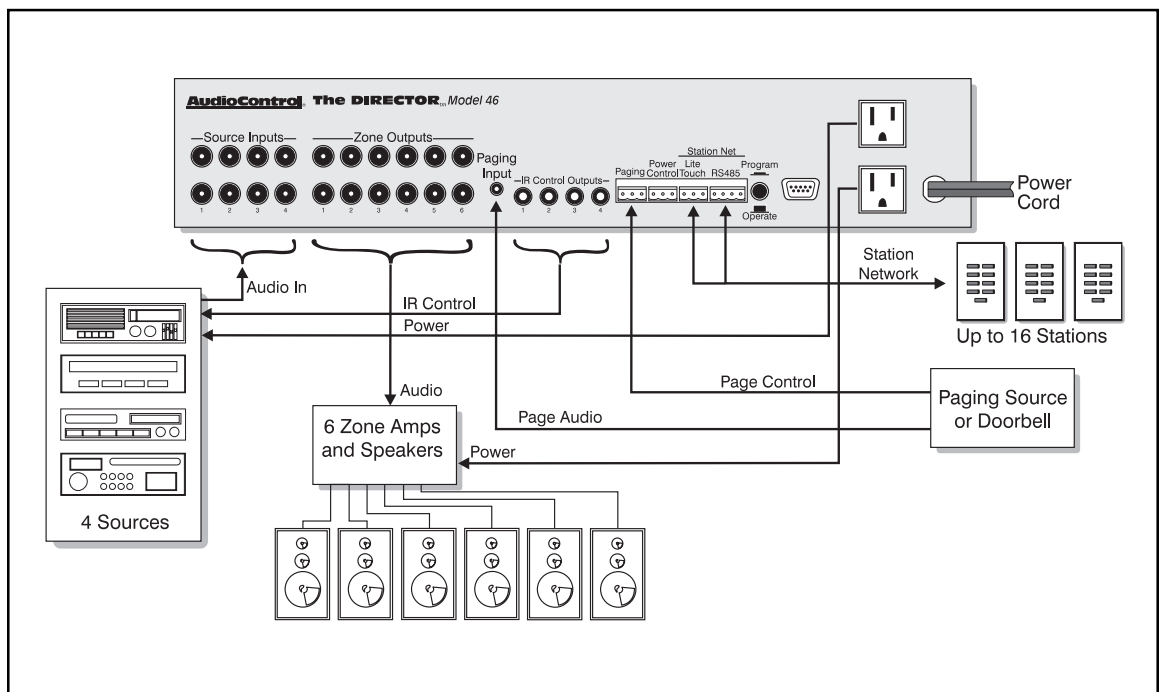

Flexible

The Director Model 46 is a complete audio multi-zone control system. The Director Model 46 handles the remote control and signal routing of up to four audio sources (such as CD players, tape decks, tuners) and the control of source selection and volume control for six independent stereo music zones. Additionally there is a mono paging audio signal input with separate control input to facilitate whole house paging for use with an electronic doorbell, telephone system or other external audio source. Each of the four sources has it's own independent control output that is used for infrared mimicking or, if the source unit supports this feature, direct connection. Infrared codes for most popular source unit models are pre-programmed into the Director. Additional control codes for equipment not in the internal library can be updated via an external PC using data files supplied by AudioControl. For more details about additional IR codes for the Director Model 46, please contact the AudioControl factory.

Stylish

The Director Model 46 utilizes attractive, off-the-shelf, LiteTouch system wall stations. This allows you to match the decor of any home and, more importantly, match the look of the lighting control system that is being installed in the home.

What? There is no lighting control system? No matter. The LiteTouch control stations are still attractive, available in a wide variety of styles and finishes and will blend in well with the decor in an audio only installation.

Smart

The Director Model 46 comes from the factory with a default set of system parameters that include preselected sources, station macros and system defaults. While we don't expect the preprogrammed configuration to meet the needs of every installation, we did want the system to do something out of the box so that you could play with it without having to learn how to program it. This setup gives you an easy starting point for your own programming so you don't have to begin with a blank canvas. You can modify the factory default program to fit your installation, delete it entirely or, if you decide to, restore the factory defaults. The configuration of all of the Director's system parameters is programmed using an external PC compatible computer running any standard communications software package that supports either ANSI or VT100 terminal emulation via the serial port on the back of the Director.

Helpful

The Director Model 46 has only two indicator LEDs on the front panel. One of these indicates that the power is on. The other one, labeled status indicates the health of the station network. Every time there is a communication with a station on the network, the status led will wink off and on again. This lets both you and the homeowner know at a glance that the system is functioning. If there is any problem on the station network, such as a stuck station, or a short circuit, the status led will go out.

Extensive diagnostic capabilities have been built into the Director Model 46 to allow you to test the various portions of the installation, including the station control network, as well as ‘self test’ the Director in the unlikely event that you think that there may be a failure or problem with the Director itself.

Expandable

The Director Model 46 handles up to six stereo zones. For larger installations, any of these output zones can be split into two separate mono volume zones. If you have an even larger system requirement, two Directors can be ganged to create a four source by twelve stereo zone system. Additional facilities have been provided in the Director Model 46 to allow for integration with other control systems when the audio system is only one part of a larger, whole house automation system. Check out Section 4 - System Configuration for more information about this.

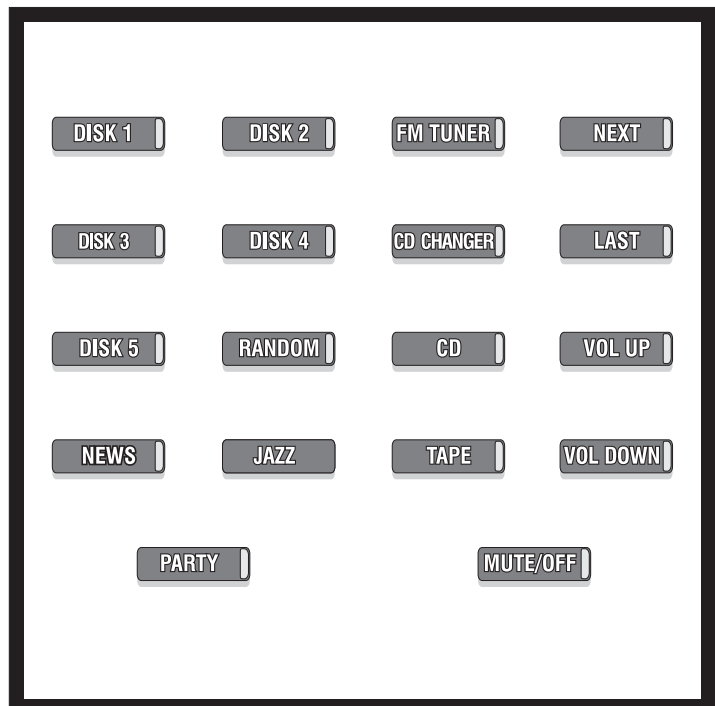
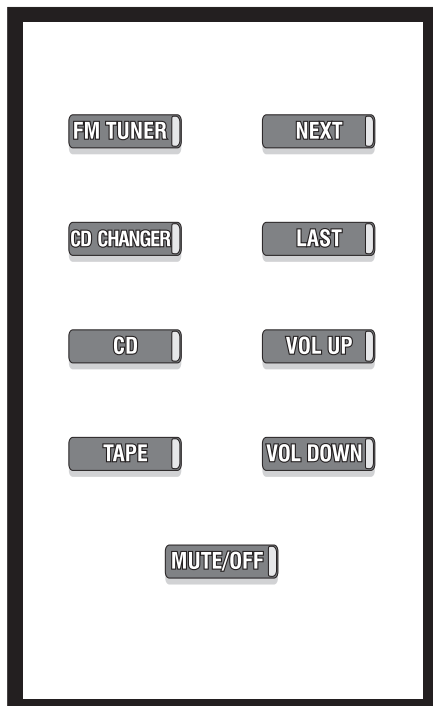

SYSTEM OVERVIEW

Homeowner's View

The part of the Director system that the homeowner will see the most is the control stations. On each control station are all of the controls necessary for complete operation of the audio system, in one convenient location. Each function key on the control station has a series of actions assigned to it, automating the process of turning on the system, selecting the source, setting the volume at a listenable level, and handling the control necessary to put that source into its music making mode. All the homeowner has to do is push that one button. The system does most of the “thinking” for the homeowner, making the audio system easy and intuitive to operate. Features such as a quick response time, ‘all off’, auto power down when the whole system has been muted, acknowledgement of actions on the station’s LEDs, etc, all contribute to the ease of use for the homeowner. You will find that most homeowners won’t require any instruction in how to use the system.

Installation Tip:

A significant part of the success of the installation will come down to how good of a job you as the installer do in setting up the various functions on the stations. Simple, logical layout and function assignment go a long way to making the system easy for your customer to use.

The Director Model 46 handles 4 sources such as CD players, tape decks, tuners, and 6 music zones. This means that there can be up to 6 separate areas in the house, each area under separate control of volume and source selection, and each of the 6 areas can listen to any one of the 4 sources, independently. Of course multiple music zones may listen to the same source, with no degradation of audio quality, and each zone retains individual control of the volume level. The only interaction between zones is in the area of source control, since there may be multiple zones listening to the same source, each of these zones will have control over the machine functions of the source.

Having said that, it must be remembered that the homeowner has no clear picture of what the system does, or how it is configured. They cannot always visualize what is connected to what, or how. So when you try to explain how pushing this button makes that machine play, they don’t always realize that there is a control system in-between (which is obvious to you). To people other than you, no connections are obvious. It would be like explaining that the Space Shuttle takes off when you adjust the thermostat; they could not make the connection.

With this in mind, let us focus on what you need to explain. A good starting place is to point out that they do not need to have extensive interaction with the source equipment. The source equipment will have all sorts of buttons like “Dolby”, “Cr02”, “hi-blend”, etc. You can explain that 99% of these controls are to be set by you, and need not be monkeyed with any further. Next explain that the AudioControl Director 46 is there to operate all this equipment for them. Once there is an understanding that the control stations are the only thing that requires any familiarity, the homeowner will

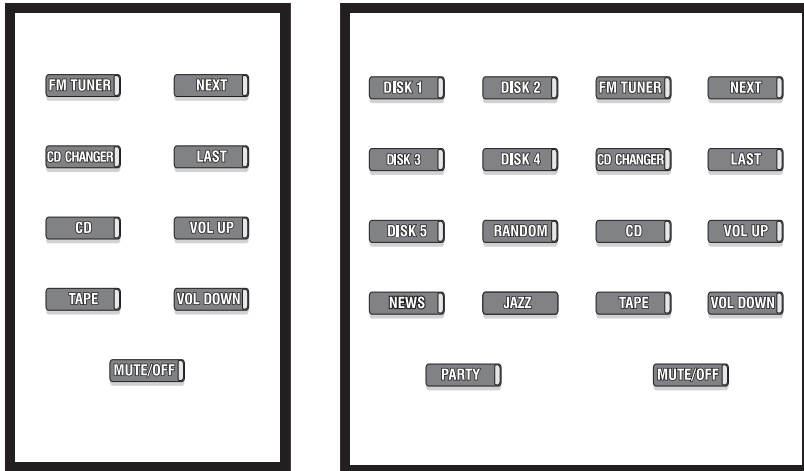

figure 2.1: Example Station Layouts

most likely feel relieved. If you show the homeowner the descriptive layout shown in figure 2-1 there should be a fast learning process. Don't push buttons for the person you are trying to instruct, instead, let them try all the functions (there are not that many), and hear the results. Then you will get the pleasure of hearing "Oh! That's it? I know how to use this now!".

Installer's View

The Director system has been designed to be easy to install. Several of the system's designers have had extensive experience in the day to day details that go into installing products like the Director, and have worked hard to eliminate all of the "pet peeves" of the existing systems in the market place. Gone are the days of individual control cables running from each wall station back to the main system unit, each cable having 7 or more conductors that need to be terminated. The Director Model 46 uses the same serial network topology as LiteTouch does with their lighting control system. If you have ever installed one of those systems, you know how simple the wiring is. Each of the wall stations has an address and all of the wall stations sit on the same set of 3 wires, communicating serially with the centrally located control system. This means that in most cases the installer only has to terminate 3 wires back at the system unit.

The wall mounted control stations contain status leds that are used by the Director to indicate the current mode of operation. We all know how the homeowner needs to be reassured that the system is doing something and is not broken while waiting for it to start up and play music. The Director indicates these wait periods by blinking the status light associated with the function assigned to the button that the homeowner has pressed. As an example, if the system is off, and the homeowner selects source 1, the system has to power up the sources, power up the amplifiers, wait for the

amplifier power up delay, push play on the source, and wait for the source to start playing. As this can amount to over 30 seconds with long delay amplifiers and sluggish sources, the homeowner will be left wondering where the music is until it starts. Rather than leave the homeowner in the dark (after all, that's the job of the lighting control system!), we've chosen to indicate that we are waiting for things to happen by blinking the led on the button you assigned to source 1. When the waiting time has past, the status led will stay on, and at the same time, the system will start making music. All of the delay times are configurable, so that you can tailor the responses of the Director 46 system to the particular sources and amplifiers in the installation.

Speaking of status leds, the Director has only two indicator leds on the front panel. One of these indicates that the power is on. The other one, labeled status indicates the health of the station network. Every time there is a communication with a station on the network, the status led will wink off and on again. This lets both you and the homeowner know at a glance that the system is functioning. If there is any problem on the station network, such as a stuck station, or a short circuit, the status led will go out.

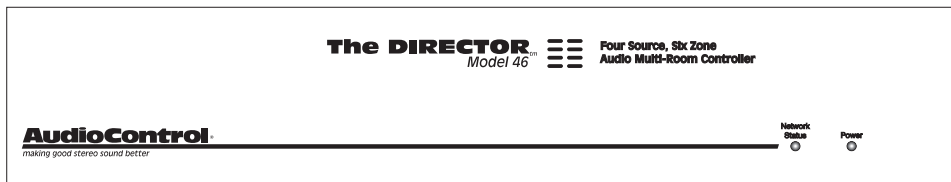

In addition, in between the two status leds is a very small hole, behind which is the system reset button. The reset button can be accessed using a

*figure 2.2 Front panel
Director Model 46*

straightened small paper clip. We chose to hide the reset switch in this manner so that it wasn't a tempting target for your customer.

Source control is made very easy by using IR control mimicking. Each of the 4 sources has it's own IR control port, into which is plugged a standard Xantech (or equivalent) IR emitter which is then attached to the source. This also means that multiple sources of the same type and manufacturer can be used with the system. It is no longer necessary to use a CD player made by Sony and one made by Yamaha, so that the IR codes don't conflict, in order to provide the client with two CD players. And since each source is controlled by a separate IR port, the Director Model 46 is able to keep track of what button it has pushed on each of the sources. Speaking of machine controls, the Director Model 46 supports up to 16 machine commands for each source. This makes it possible to do such things as fake out the CD player so that no matter what mode it was previously in, it will always go into normal play when the source is selected, directly access a specific disc, even if it was previously in random mode (this is a bigger problem than it first appears, especially for Sony multidisc changers), direct numerical entry of a station preset or channel on a tuner or DSS receiver.

Inclusion of a paging input with control signals in the Director Model 46 makes the integration of external systems such as a phone system or electronic door chime easy. There is a mono audio input which can have the level adjusted in each zone separately, along with a control circuit input that can support either a contact closure or AC/DC signal voltages. The control circuit is optically isolated from the audio portion of the system, to minimize the possibilities of ground loops or noise being introduced into the audio system. Additional features on this input include: minimum closure time for operation of paging; minimum open time for release of paging; a maximum time limit for paging; paging volume levels for each zone independent of the level of the music or program material being listened to in the zone and enable paging in muted zones

Control of power for sources and amplifiers has been provided in the Director Model 46 in two ways. The first is with two switched outlets on the rear panel of the Director. The combined load of sources and amplifiers plugged into the outlets is not to exceed 1200 watts. If there is a need for additional power capacity, or the installation calls for relocation of the sources or amplifiers, there is a terminal block on the rear panel of the Director that provides 12 volt control voltages for power relays. The 12 volt control signal is also used to interconnect the power control of the AudioControl Architect Model 1250, which is the companion amplifier to the Director Model 46. One Director Model 46 and one Architect Model 1250 are all that is needed for audio signal processing for six stereo zones! Please refer to Appendix C - Connectors and Signal Information for additional information and application hints concerning the use of this terminal block.

The Director is an installer configurable system. You can program actions for each button on a control station, customizing the configuration to the needs of the installation at hand. We've tried to take some of the flexibility that is found in the lighting control systems manufactured by LiteTouch (Salt Lake City, UT), and apply the concepts to the control of an audio system. The Director has two distinct operating modes, Normal operation and Configuration. These two modes are mutually exclusive, meaning that while you are in the Configuration mode configuring and setting up a Director system, the control stations are not available to

*figure 2.3 Rear panel
Director Model 46*

control the system. When you are done with the configuration and put the Director into it's normal operating mode, everything becomes operational.

Another feature of the Director is an easily changeable front panel. So what does this mean to you and why should you care? Well, we've all had to do that custom installation where the client or designer is insisting that the audio equipment match the cabinet finish of faux goat skin. In the interest of keeping the Director's price low, AudioControl has made the decision that we would provide the Director Model 46 in any color you wanted as long as it was black (sort of like Henry Ford). This leaves the matching of that special custom decor up to you, the installer. So we tried to make it real easy for you to do this, at least with the Director, as you will probably have numerous other pieces of equipment that may present you with difficulties that we'd all rather not discuss! The Director has a front panel that is a single piece of flat steel, 1/8" thick, that has only 9 holes in it. There are no electronics mounted to the inside of the front panel. You may replace the front panel with anything you desire, with consideration for the mechanical dimensions and requirements of the Director. There is a drawing for the two types of front panels - rack mount and stand alone, located in Appendix K for just such emergencies. Have at it!

As you can see, we're on your side. There are more features, oriented towards a successful installation, that are detailed through out this manual. Why not take some time and read through it and see for yourself?

Designing and Planning an Installation

Installation Considerations

The successful installation of a Director system is dependent upon adequate planning. A little extra time taken at the beginning of the project can help ensure that the installation goes in with a minimum of trouble and time, and remains a reliable functioning system until such time as the homeowner desires to upgrade the system. It will also mean that in the unlikely event of a failure with the system or one of the sources, there will be a minimum amount of time spent in the troubleshooting and repair of the system.

System Planning - Homeowner's view

When planning the locations of the wall stations, consider how the home owner is going to use the system. What is the function of the room? Where you locate the control stations for that room will be different for the dining room, where one station on the wall next to the entrance way (two doorways, two stations, more to sell the client!) will usually suffice. In a den or family room, it might be a nice touch to locate a table top station next to the comfy chair, in the library it might end up on the coffee table or an end table, and in a bedroom an obvious place is at the bedside. Is there a location that would benefit from a master station that controls more than one room, say by an entry way that the homeowner comes in every day? Try to consider the locations of the audio wall stations in the same way as light switches. When you enter a room, you want to be able to turn on the music (lights), right? All simple things but sometimes overlooked. And if the house has a LiteTouch lighting control system, you will be able to locate the audio stations in the same places as a lot of the lighting control stations. This makes for a much more attractive installation.

We'd like to make a few suggestions about station button layouts. One of the most frustrating things for users is when each station has a different way of doing the same thing. On most other multiroom products this is a non-issue, however with the programming flexibility built into The Director Model 46™, it is very easy to get carried away and end up with 16 stations, each with a different way of turning on the system and selecting a source. Needless to say the homeowner would end up finding this very confusing! With some of this in mind, and referring to the station illustrations in figure 3-1, we'd like to suggest five simple guidelines:

- ❶ Be consistent! If you have 1 & 2 gang stations, try to keep the essential functions on the 2 gang stations identical to how you have done this on your 1 gang stations.
- ❷ Start with a list of features that you consider as being essential for a given location. Ideally you would work out a set of features that would be

available in every room in the house, and would form the basis of a common station layout.

- ③ Organize things by group or function. All source selects in one area, etc. Likewise for machine control and groups of volumes or mutes.
- ④ Invoke the “Hot Key” idea, whereby you figure out what the customer is doing most often and give them some “express” means for doing that. An example of this is a button that says “NEWS”. Using the macro capability of The Director Model 46 the “NEWS” button can be programmed to: turn the system on, select the first tuner, select preset 1 on the tuner (tuned to the “All News All the Time” station) and unmute the audio in the room.
- ⑤ Somewhat along the lines of the hot key is the inclusion of the homeowner’s “pet” features (which are only known if you spend time interviewing the homeowner (don’t forget the homeowner’s significant other!). Very often the homeowner has in his or her mind some feature that they simply must have. Since The Director Model 46 has up to 16 machine commands for each source, and 24 macro steps per control station button, this can usually be implemented without difficulty. A hypothetical list of “pet features” some of which are illustrated on the two gang station in figure 3.1 are:

“WQCD-FM”

Gets you instant, one button access to the smooth jazz radio station (set in preset 1) on the currently selected tuner. “WQXR-FM” gets you instant, one button access to the classical music radio station (set in preset 2) on the currently selected tuner.

Other tuner or DSS presets are possible. Note that if the system only has one tuner, that the macro for that button could also turn the system on, select the tuner, set it to the respective preset and unmute the room, the same as the “NEWS” button example above.

“CD RANDOM”

Puts the currently selected CD player into random play mode.

“CD CONTINUE”

Takes the currently selected CD player out of what ever other mode it was in and puts it into continuous play mode.

“PARTY”

Turns the system on, selects CD player #2 in all the zones, pushes the ‘play’ button on the CD player and unmutes all the rooms.

“FM/CD-1”

(1 through 5, total of 5 buttons) if source is a TUNER, selects the corresponding FM preset (1 to 5), if source is a CD player, takes machine out of what ever mode that it is currently in, selects the corresponding disc and pushes play.

**“FRONT SPKRS/
REAR SPKRS”**

(4 buttons) in a large room, control of levels in the front and back of the Room (or just mute the two sets of speakers, requiring two buttons for mutes, two buttons for master volume control).

- “**AREA MUTE**” Mutes several zones in connected rooms (typical open flow house) or an area.
- “**MSTR VOL**” Ratiometrically increases a group of volume zones
- “**MUTE/OFF**” Push and release mutes/unmutes the room, press and hold turns the system off.

In figure 3.1, we are using the LiteTouch ‘H’ (horizontal rectangular button) style stations. The source selects are grouped in a single vertical row of 4 buttons. Notice that for the single gang station this is on the left side of the station, and that it appears in the corresponding location on the right hand gang of the two gang station.

Figure 3.1 Example station layouts.



System Planning – Installer’s view

One of the aspects of system planning that contributes heavily to a successful installation is the documentation of the installation, both as planned and as installed. Things that should be included in the pre-installation documentation are:

- Cable runs and paths.
- Cable labels and their meanings.
- Color codes of individual wires and their assignments.
- Station addresses cross referenced to their locations.
- Source assignments and the desired machine control functions.
- Paging input source if used and control method.
- Amplifier channel assignments.
- Power requirements for each source and amplifier - does it exceed the capacity of the Directors’s built-in power control? If so then external power control will have to be factored in. Note that the Director has an output with 12 volt signals available for just such an occasion.
- Rack layout - will all of the equipment fit in the allotted space?

A great deal of the system considerations will revolve around that old business maxim “Location, Location, Location”. In a lot of installations, the location of the audio system has been predetermined by the designer or client, and will have to be made do with. However, since 10 pounds of rocks won’t fit into a 5 pound bag, it is up to the installer to say to the designer/client when it simply “won’t fit”. “Won’t fit” includes a number of issues that won’t be immediately apparent to the designer/client such as:

figure 3.2 Typical system block diagram.

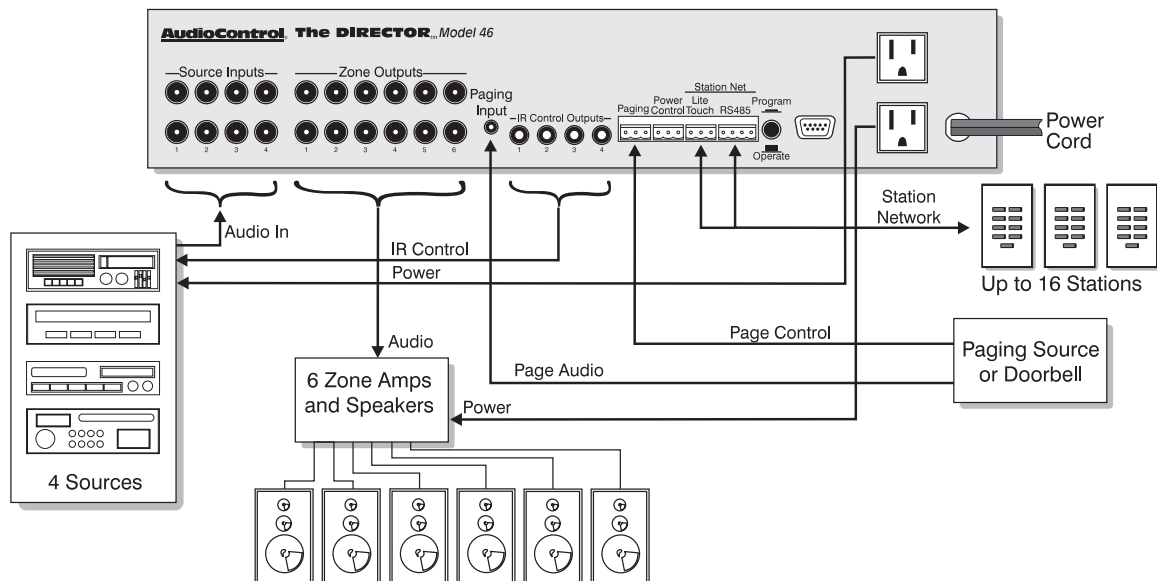

Adequate space for equipment and cabling - is there enough room behind where the equipment is going to allow for the connectors, cables, etc? Can the rear of the equipment be gotten to once it has been installed? No? Well, how are you going to wire it, then? We've all done those shallow rack installs where we have to balance the equipment on one hand, connect the cables with the other, then hold it in space against the rack rails while trying to get the screws in. And dreading that we might have to ever take a piece out of there. Only to discover that between the designer not giving you the extra two inches you asked for, the cabinet maker telling you that the distance from the front of the cabinet to the back of the cabinet didn't include the recessed doors, and the key piece of equipment that the client had to have was an inch too deep to start with. Is there extra room in case a source is replaced with a different model at a later date?

Sufficient ventilation - is there adequate air flow? Does the cabinet or rack include space for vent grills, etc? Will fans be required? Can the fans be located such that the client won't be aware that they are there? Will the fans need to have filters on them? If so, how are the filters going to be cleaned or changed?

Practicality (what, a client be practical!?) of use by the client. Kinda tough to change the disc in the CD player when it's mounted up against the ceiling, eh?

Is the location such that every single cable run will require more than 1000 feet of cable? Is the distance from the power amplifiers to the speakers such that it will take half the contents of a copper mine to fashion cables thicker than a garden hose to get the signal to the speakers at a level that is usable? If you have this problem, you may want to consider using remotely located amplifiers in the distant part of the house. By the way, AudioControl has anticipated this type of situation and we have several products that will make doing this a lot easier. To get the audio from The Director Model 46 to the remote amplifiers, we manufacture a pair of products call the BLD-10 and BLR-10 Balanced Line Driver/Receiver, which will allow you to transport the audio up to 1000' over ordinary CAT 5 twisted-pair cable. And the AudioControl Architect Model 1250 amplifier has provisions for remote power control, which when used with the power control outputs on the Director will allow you to remote this amplifier and still have control over it. Just one of the things we are trying to do to make your installation a little easier.

Is there any source of environmental stress in the location of the system? You know, things such as hot water or steam pipes running through or next to the cabinet, direct sunlight shining on the

system for the entire day (somebody pass the sun tan lotion!), etc? How about in the air? Is the system located such that the cold air return for the furnace goes through or around the system cabinet? Or located in the kitchen, over the stove or deep fat fryer, not to mention those installations next to the chlorinated indoor pool?

Electrical requirements - can the electrician get enough dedicated circuits to the system's location?

A Quick Comment Concerning Audio Cable

While there are a lot of claims in the High End audio industry and we have noticed that at times this issue can resemble a religious war, we do want to say a few things about this issue with regards to the installation of a Director. The Director has been designed to be a high performance audio product and part of the long term success of the installation will depend on the quality of the cabling used for the line level audio interconnects. We highly recommend that the RCA plugs on the cables used with the Director be of a high quality. Why? Well in a typical Director installation, the system will be wired up, and the wiring will not be disturbed for several years. If inexpensive connectors with inferior plating are used, they will oxidize and corrode over time, causing the quality of the connection and the performance of the audio system to deteriorate. High quality connectors, mated to high quality cabling, will help assure a long life, trouble free installation with excellent audio performance.

Network Wiring

The station network cabling needs to have some special consideration given to it. Since the system has the capability of running only one cable from the Director out to the network of stations, it is important to arrange this network in an orderly fashion, if only to facilitate troubleshooting in case there was damage done to the cables during or after installation. Those sheet rock guys will ruin the party every time by putting a screw through your wires! There are more details for station network cabling later in this chapter.

Physical Access

We mentioned above that accessibility in case service is required is a good idea. While we don't think that you will have any problems with the Director during installation, or in the future, we do know that CD players, tape decks and other electromechanical devices have the annoying habit of wearing out. Will it be possible, without turning into a contortionist, to get to the rear panel of the piece of equipment to disconnect the cables and remove it? If space can be made for it, one of the many slide out racks that are available on the market, are a life saver in this kind of situation. This does of course, require that there be space available, on a temporary basis, in front of the rack to slide it out, as well as the space that the rack takes

Important Note:

If you are planning on using the Director with another automation system via the Director's RS232 serial port, and you will have LiteTouch wall stations connected to the Director, that the total number of stations, both physical and phantom, must be 16 or less. Please refer to the Configuration section of the manual for more information on this.

up when back in it's normal resting place. (Imagine the frustration of having the interior designer go through the trouble to get you a separate closet for the equipment, only to find out that the door to the closet must be removed to get the slide out rack to slide.... These things happen!)

System Configurations

The Director system is available in two configurations. The standard configuration is a single Director Model 46 system unit, which can control 4 line level sources, and route the audio to 6 separate stereo output zones, 12 split mono zone, or a combination of stereo and mono zones. The expanded configuration, consisting of two Director Model 46s, can control 4 line level sources and route the audio to 12 separate stereo output zones, 24 split mono zones or any combination there of.

Station Network and Installation notes: The station network consists of the wall stations, optional IR receivers, and the Director, interconnected with 3 or 4 wire cabling.

Control Stations

Network Notes: LiteTouch stations use a 3 wire network that may be daisy chained, home run, or some combination of both. The three wires encompass a network consisting of a power wire with an unregulated 15 volts DC on it, a ground and data return wire, and a bidirectional data wire. The station connects to the network with a 3 pin connector and a supplied pigtail connector with 6 inch leads. As the ground wire is also the data return wire, voltage drops in this wire must be kept to a minimum for reliable operation of stations,

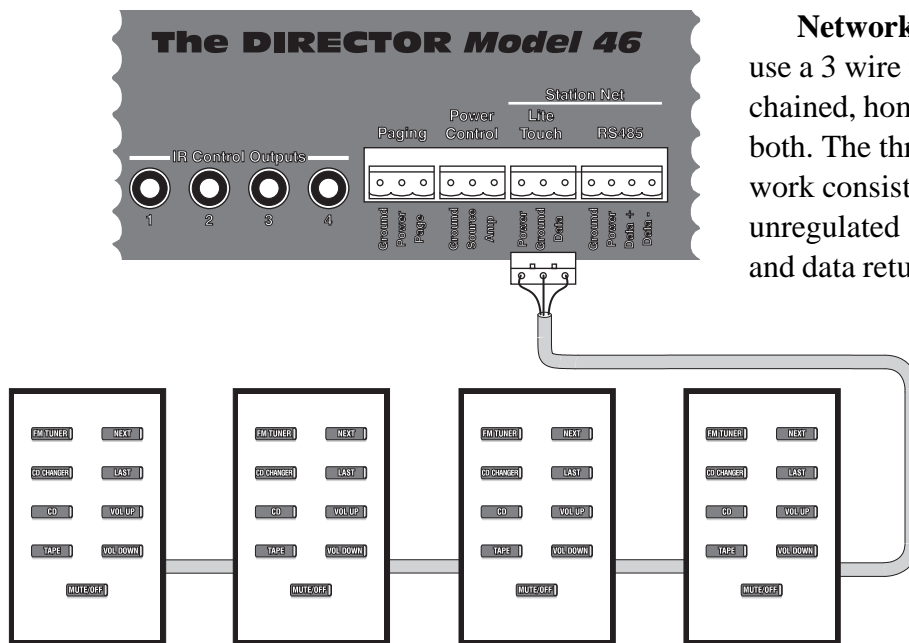

Figure 3.3 LiteTouch station network cable connections

especially stations that are located a great distance from the Director. If there are long runs of network cable, especially with a number of stations located at the far end, it is desirable to use 4 conductor wire, and use two conductors paralleled together for the ground wire. It is also important to use good, solid, connections for all splices in the network cabling and where the network cabling is joined with a station pigtail. It is suggested that either crimp butt splices with a good crimping tool (sorry but those

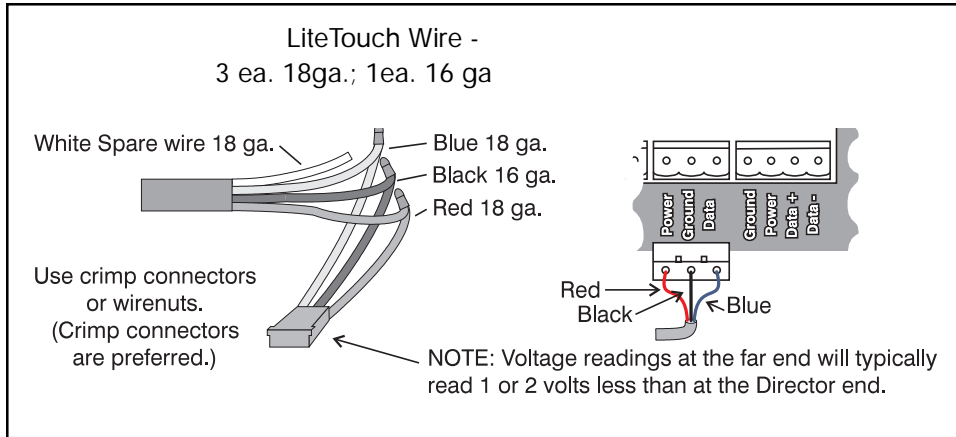

Figure 3.4 LiteTouch station cable connections

possible 256 addresses. Each station must have a unique address assigned to it. Addresses are selected by setting the two screwdriver adjustable address switches on the top end of the back of the station. The switches are best viewed by holding the station upright, with the buttons of the station facing away from you. This will put the most significant address switch on

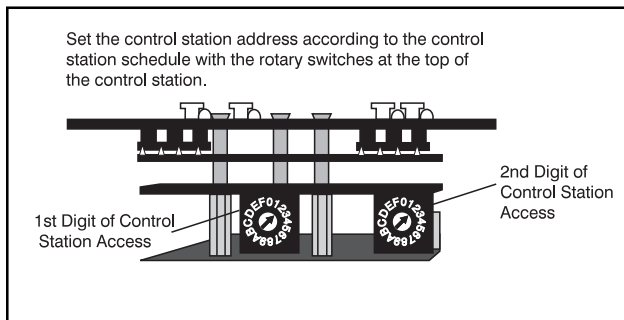

figure 3.5 Setting LiteTouch control station addresses.

Installation Tip: Network addresses 00 & FF are reserved. Do not set a wall station to these addresses.

the left, and the least significant switch on the right. If you have a doubt as to which switch is which, the switches are labeled on the printed circuit board. You will notice that the switches are labeled 0 to F, not the obvious 0 to 9. The Director system will work with whatever addresses you select, with the exception of station address FF which is reserved for internal use by the Director software. Also, when configuring the Director, you will be entering the actual switch settings, so you don't have to worry about the mental gymnastics that are involved in converting a station address of 3F to decimal 63.

Since the LiteTouch station has 256 possible addresses, there are many possible ways that one could configure the station addressing in a system. The direct approach is to use addresses 1 to 16 to correspond to stations 1 to 16, and cross reference the addresses to the relevant zones in your paperwork. Another straight ahead approach is to use the most significant address switch to represent the zone number (1 to 6) and the least significant switch to represent the station number in that zone. For example, station addresses 11 and 12 would be stations 1 and 2 in zone 1, station address 31 would be the first station in zone 3, etc. No matter how you choose to address the stations, you must keep good records of the addressing! You will be needing this paperwork to configure the Director during programming. We've provided some work sheets for you to use located in Appendix H.

cheap stamped frame thingies that also strip wires and cut screws don't qualify for the 'good' label), or soldered splices be used.

Addressing Stations

LiteTouch stations can have any one address out of a

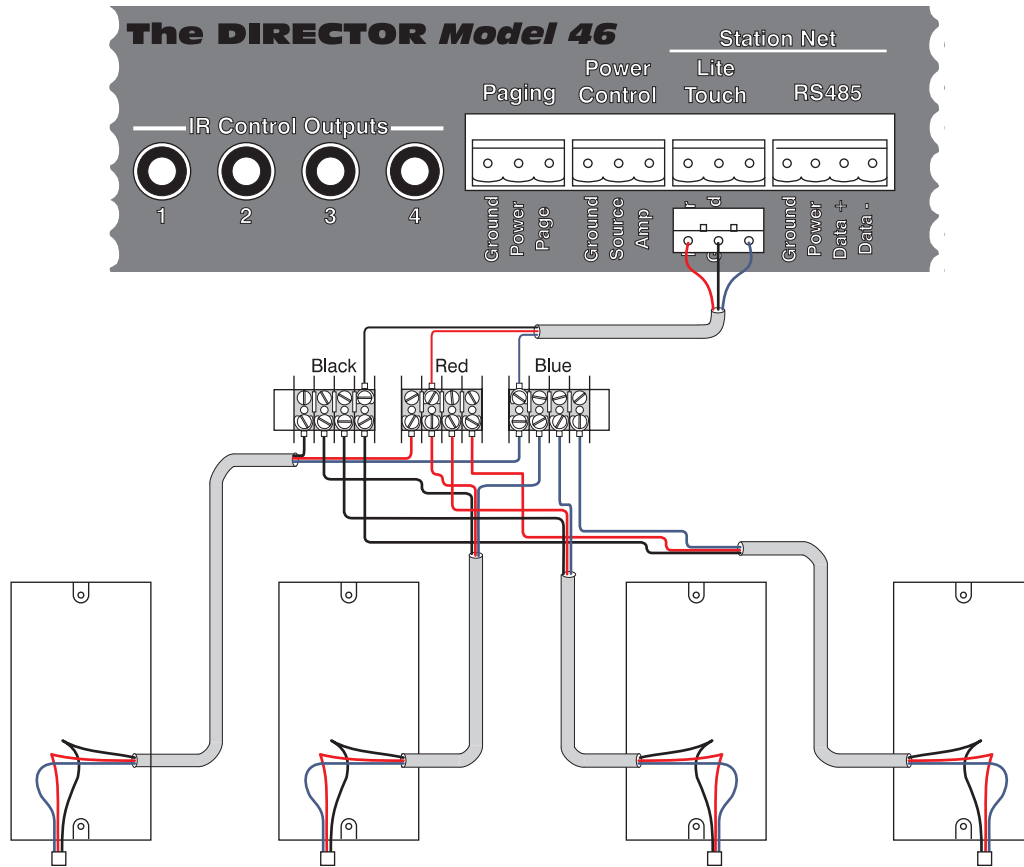

figure
3.6 LiteTouch station
network cable
connections.

Home Run vs. Bus (Daisy Chain) vs. Ring Topologies

There are many ways to string the control station cabling (spaghetti, anyone?). We would like to touch upon the three major methods of wiring the station control network. Any particular installation will lend itself to one or more of these methods, with some installations calling for a combination of methods. One of the important points to each of these methods is that there is a particular mind set that goes into troubleshooting the station network, and that the troubleshooting methods will vary depending on the network topology. With this in mind.....

Home Run Topologies

A home run network is just what it sounds like. Each station has it's own set of wires that are run from the station back to the Director. In the Director's location some arrangement is made to terminate all of the station cables and get them to the Director system unit. The method of interconnection can be something like a set of terminal blocks with multiple common terminals or the like. Simple and straight forward to setup and wire, as each station goes back to the head end, this installation method consumes the most wire, and will take the most time to pull cable for.

Additionally, each cable needs to be marked at both ends with it's source and destination, in a manner that will defy the march of time. Nothing can be more of an inconvenience than working on an installation several years later where half or more of the cable marker labels have fallen off due to age. And one can never stress too much that documenting the cable layout is of major importance to future maintenance of the installation in the event of trouble.



Advantages: Troubleshooting can be done at the Director. If there is a stuck station bringing down the network, each station can be lifted from the network at the terminal block, one at a time, until communication with the Director is reestablished. A cable that was damaged in installation only affects that one station.



Disadvantages: A lot of wires at the Director end! As each station has 3 (LiteTouch) wires running to it, with 16 stations there will be at least 48 wires to interconnect. And while this is significantly less than what is involved in some of our competitors' systems, it still is a rat's nest!

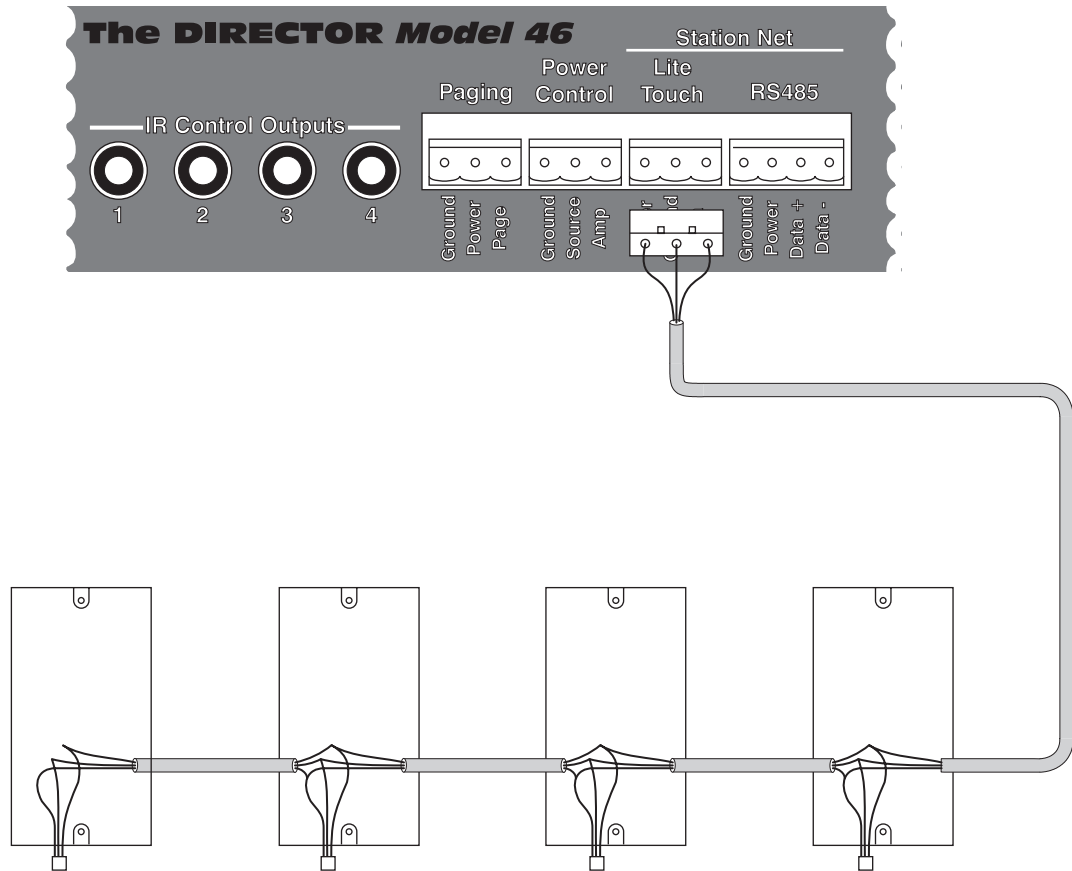

figure 3.7 Daisy chained station network wiring topology.

Bus or Daisy Chain Topology

A bus network is also known as a daisy chain. There is one cable run from the Director to the first station. Then the second station “daisy chains” off of the first, the third off of the second, etc. Simple and straight forward to setup and wire, this method consumes the least amount of cable necessary to wire the whole system. In an installation of this type, it is necessary to mark both ends of each cable segment with the source and destination for that segment. Additionally, it is very important to document the runs of cable, with the source and destination written down for future maintenance and troubleshooting. If possible notes as to the actual path the cable takes through the walls are not a waste of time. All wiring labels should be indelible, and should be able to withstand the test of time for as long as the installation is anticipated on lasting. Nothing is more frustrating than trying to trace the cable runs, without the labels present on the wires as they emerge from the wall and connect to the station.



Advantages: Simple to install, with a minimum of materials and time. Only one cable running from the Director to the first station on the network.



Disadvantages: Troubleshooting a network with a stuck station requires going from station to station, disconnecting the suspected station, and either going to another station to see if operation of the system has been restored, or swapping in a test station and verifying if the network has been restored. If the cable run from the Director to the first station is excessive in length, then larger gauge wire must be run. Damaged wiring can not be easily bypassed.

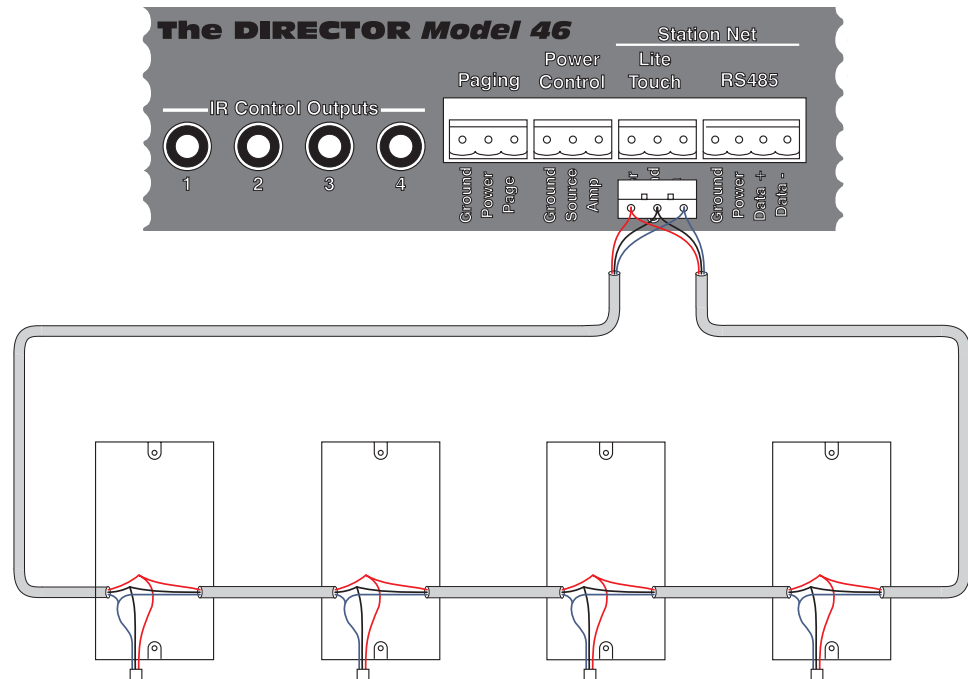

figure 3.8 Ring or loop station network wiring topology.

Ring Topology

A ring network is also sometimes known as a loop. It is the same as the bus or daisy chain network, with the additional cable run from the last station back to the Director.



Advantages: With this topology you gain the advantages of the simplicity of the daisy chain installation with an additional degree of robustness in the case of a cable failure. A damaged cable segment can be disconnected at both ends, leaving two daisy chains. There is only a minimal amount of additional cable and time required to install the run from the last station to the Director, making the network a loop. Documentation (we've hammered this in by now, right?) is still required along with the need to permanently label the cables with their source and destinations.



Disadvantages: Same troubleshooting issues as the daisy chain network topology.

IMPORTANT!

Do **NOT** use shielded cable. The extra capacitance in the wire prevents proper station network operation.

Wiring

So what does all of the above mean in the real world? Well, the particular circumstances of an installation will dictate to some degree how the station network has to be laid out. In most installations it should be possible to divide the station network into two loops, each one containing half of the total number of stations. This offers the best compromise of all of the advantages and disadvantages of each of the three station network topologies. Total amount of materials and time needed for installation is no where near that of the home run topology, system integrity is considerably improved over the single daisy chained topology, and the troubleshooting advantages of the home run topology are applied to the loop topology as much as is possible. A stuck station can be isolated at the Director end to one of the two loops, which then necessitates the removal and reinstallation of at most 7 stations until you find the bad one. In addition, at the worst, a damaged section of cable will only affect one loop, and will result in only 8 stations being turned into one or two daisy chains. Also if the initial cable runs from the Director to the first and last stations on a loop is lengthy, there is no need to double up on the size of the wire.

The single most important issue in wiring the station network is to document the installation! Yup, we've said it again! There should be paperwork that is readable and understandable by someone other than the installer that explains what the markings on the ends of the cables translate into with respect to the locations in the home. Ideally this should also include station addresses.

The second most important issue is cable type. LiteTouch recommends unshielded cable. LiteTouch uses a special cable that consists of 3 - 18ga conductors and 1 - 16ga conductor. The 16ga conductor is used as the power and data common. It is perfectly acceptable to use 4 conductor 18ga cable with the LiteTouch stations as well. Simply parallel two of the conductors for the power and signal common. This does allow you to prewire the installation for stations before the final decision has been made as to which type of station is going to be used.

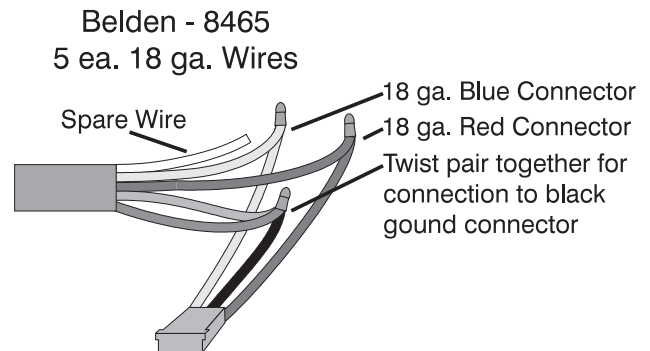

figure 3.9 LiteTouch cable specifications with optional paralleling ground conductors.

The third most important issue is the routing of the station network wiring in it's travels throughout the installation. The LiteTouch station network was designed to be used in residential lighting control systems, and was designed to be resistant to interference. Whenever possible however, we advise against routing the station network cabling along with high current power lines that may be present in portions of the installation. While it is unavoidable to have to run along side power lines for short distances, the intentional bundling of station network cables with power wiring, especially over long distances is to be avoided. This is to prevent induced noise from the power lines into the data lines from causing interference with the station network operation. Station network cabling should also not be bundled with low level audio cabling such as that which runs between sources and the Director, or between the Director and the amplifiers. While not an ideal situation, station network cabling can be bundled with the speaker cabling, but we don't advise it.

Control Station Mounting

A final issue when using LiteTouch stations is the back box. Most of the control stations you will use for audio installations will be single gang stations. This does not mean that the stations will fit in any "single gang wall-box"! Low voltage lighting control stations from LiteTouch have microprocessors and other support electronics mounted on the back of them, and consequently are bigger than most switches, dimmers and outlets. The only safe solution (and believe us when we tell you that under-sized boxes in a finished house is as about as much fun as a collision at sea) is to get a sample station and try it out at your local home center or electrical supply. And if you are having the electrical contractor on the job deal with your low voltage cabling, make sure that you specify the type of box that they are to be installing for the stations.

A quick note about box types: if you are using the gangable "gem" boxes (3" x 2" single switch box), which are metal and expandable to various sizes, you will find that these are totally unsatisfactory for LiteTouch stations (and other things). Also avoid "handy-boxes", they can be too narrow. If you are using metal boxes due to masonry construction or compatibility with high voltage boxes, you will need to use the two-piece type of box. The front is typically a 1 or 2 gang plaster ring, available in different depths (for thicker plaster or sheet rock), and the back is a 4" square box, usually called a "1900" box. You will find this quite roomy. If you use a plastic box, make sure you use the largest type you can find (don't worry about depth) and make sure that the screw holes for mounting the station are within the walls of the box. If they are on the outside, the box may be too small. Again, it is wise to try before you buy, as the boxes were originally designed for switches and outlets. If wish to retrofit a box,

you will probably want to use a plastic box with flip up tabs to anchor the box inside the wall. You can also get away with just using a plaster ring without a box, if you have a method of securing the ring inside the wall, especially if you have a problem with limited depth or a pocket door behind the station. You may wish to consider some method of protecting the electronics on the station from plaster and other dirt and debris present inside the wall.

Station network cabling, the National Electrical Code (NEC) and the local electrical inspector

First, are there any differences between using lighting control stations for lighting and using lighting control stations for audio? The answer depends on how the NEC is interpreted by the electrical inspector in your area. While the station network cabling is current limited Class 2 wiring and as such is subject to the same rules governing other low voltage cabling, if the cabling is connected to the lighting control system, a lot of inspectors (New York City comes to mind...) like to see the network cabling treated as Class 1 wiring, and treated in the same manner as the line voltage wiring in the house. This means that if the 120 volt circuits are in conduit, BX or Greenfield, they'd like to see the control network cabling dealt with the same way. So what has this got to do with an audio system? No electrical inspector will treat the audio control stations or wires as Class 1. However, if you choose to gang the audio stations with the lighting control stations in some locations, then you have to consider adopting the highest common denominator. And treat the audio station network in the same manner as the lighting control station network. This is usually only a problem in areas where power wiring is required to be in conduit, BX or Greenfield. If you see them stapling Romex inside the walls, then you can be pretty sure that the control station wiring won't be an issue. If in doubt, consult the local electrical inspector. Some other considerations:

- If you are doing the lighting control as well as the audio system, you should make sure that you understand the local and national codes and may wish to discuss the installation in advance with the inspector, even if there is a licensed electrical contractor involved.
- If you are not a licensed electrical contractor, and are doing lighting control projects along with the audio installation, you should have a "Electrical Contractor Responsible for Code Compliance" disclaimer on your contracts and documents.
- You may wish to use the Electrical Contractor on the job to pre-wire your low voltage wiring, to help your relationship and keep your scope of work manageable. If you do, make sure that you inspect and test the cabling BEFORE the walls are covered up and it is too late to do anything about it!



AN IMPORTANT SPECIAL NOTE ABOUT THE STATION NETWORK AND GROUNDING

The Director Model 46 station control network is not directly connected to ground at the Director. We have done this for a reason. In the course of installing stations, there are numerous places where the station front plate (connected to network ground) could contact a grounded surface or object. Installations with steel studs and BX cable for the electric work come to mind. Anyway, if we had connected the network ground to the AC ground at the Director, this would have also connected the audio ground to the network ground, and could result in a difficult to troubleshoot hum problem. What we recommend doing is to connect the network ground separately to a solid electrical ground. It becomes very important to do this if you are installing stations in locations where the person using the station could possibly contact another grounded object, such as bathroom plumbing or outdoors. Also note that if you are ganging lighting control stations together with audio stations, the lighting control system grounds the station network, and you will be grounding the Director station network by ganging the stations onto the same mounting plate.

Selecting Source Units

Machine control with a real control system allows all equipment to operate in a consistent, rational fashion, no matter who the manufacturer is or how silly their idea of ergonomics is. If you have installed other audio systems before, you know that consumer hi-fi equipment doesn't not inherently operate in a manner that seems logical or consistent. The Director Model 46 is intelligent enough to outsmart or "fake out" the source equipment!

Two of the main criteria for selection of source equipment are:

- 1) IR remote control capable. As the Director uses IR mimicking to control the sources, this capability is critical to the success of the installation. It will be easier to use a source made by one of the manufacturers that are resident in the Director, however by contacting AudioControl and sending the remote to us, we can capture the commands from the remote and return a disk with the remote allowing you to upload the commands to the Director (the source unit did come with a remote, right?) The exception to this is with sources that are capable of being directly controlled with an external control port on the back panel. Sources such as these are made by Sony (S-bus), Marantz (RC5) and others. Please contact your AudioControl representative or the AudioControl factory for more information on the availability of adapters for these direct control ports.
- 2) Line level audio outputs. The Director is a line level audio control system. There are no provisions for controlling the output of a

source that is at speaker or some other level. Line level outputs should appear on RCA connectors, or custom adapter cables will have to be provided by the installer. Line level outputs should be in the range of 500mV to 2V at maximum output. Ideally the source should not have a user adjustable output control on the front panel that the client could possibly misadjust, causing you a service call.

If you are building custom multi-room audio systems, you will wish to execute simple commands which are apparently on the manufacturer's remote, however they are only nominally on the remote. Pushing a button marked X may not get you the X function because of some other conditional state that the source is in. As an example: Take a popular 5 disc CD changer (made by a large Japanese electronics conglomerate), put it into shuffle mode (where it randomly plays tracks of all of the discs loaded into the machine, possibly changing discs between tracks), and after listening for a while you decide that you wish to listen to disk #3. So you press the button on the remote for disk #3 and what happens? Nothing! Why? Because you are in shuffle mode! And the direct disc selection feature is conditionally disabled depending on the overall state of the machine and the mode that it is playing it at the time you press the disc #3 button! What this means to you, the installer, is that you need to make the control system do some fancy foot work just to get the source to behave in the manner that you desire. In this example what you would have to do is build a macro for the disc select button that: 1) Stops the machine; 2) Selects disc 3; 3) Presses the play button.

So what you need to deal with a piece of source gear like the one in the above example is a multiroom audio product with a real control system running it. The Director Model 46 is just such a system. With 16 machine control commands (such as play, stop, disc 1, etc), 24 macro elements per station button, and the ability for you, the installer, to configure what each button on each station does and exactly how it controls each piece of source equipment. Elaborating on the above example:

You have a SONY CD changer (yeah, the above mentioned CD changer is made by SONY), and you wish to have the ability to select "shuffle" by remote control. That's nice. How do you cancel "shuffle"? What happens if you accidentally press "shuffle" again? (It goes into "shuffle-single-disc"!) Ok, so push continue, but that does not "reset" to "all discs" and toggles that function if pressed twice. All this is very simple if the machine is in front of you, the remote is in your hand, and the manual is on your lap. What do you program the Director to do? You set it up so that it always pushes "program" and then "shuffle" or "program" and then "continue". If no one monkey's with the front panel of the machine it will stay in "all discs" and not toggle to "single disc" just because you pushed "random" or "continue" another time.

What is really fascinating once you get into it is that these machines all have such different idiosyncrasies! One machine that we've seen combines "play" and "pause" on the same button! DO NOT use this machine!! Keep in mind that you will have to spend some time with a piece of source equipment, the manual and the remote to determine what the idiosyncrasies exactly are. And when you discover them, make sure that you try the odd combinations. Nothing is worse than having the client find the magic method of making the source stand on it's head, without having a way to get it back right side up. And make sure that you document the behavior!

Idiosyncrasies to avoid:

- ❶ Any source that has a "ratcheting" function. What do we mean by "ratcheting"? Any source where the manufacturer has decided that there should be 6 different functions all selected by one button. And depending on which function you are currently in decides the number of presses of that button that are needed to get to the new function that you want. With no other method for getting back to the first function selected by that button (except for watching the front panel indicators and pressing the ratcheting button until the right indicator is lit...). These types of sources (or at least the features that are on the ratcheting button) are impossible to control with any type of automation system without bringing status information back out of the source (just like the front panel indicators do) to the automation system. **STAY AWAY FROM THESE TYPES OF SOURCES!!!** They will only cause you endless hours of grief and heartburn!
While it may appear that the above SONY CD changer is a candidate for this category, it has two redeeming features that save it. They are: a) It reverts to a default state upon power up; and b) There are other ways of canceling the particular feature and restoring it to a known state.
- ❷ Sources where a small group of buttons select between multiple pages of similar functions or presets, with no way back to the first page of presets. Tuners are notorious for this. You know the type. There are 14 banks of 12 presets, and there is neither a direct access method to call up a preset by number nor a way to get back to the first page of presets. Yet more heartburn!
- ❸ Try to select sources that have mechanical power switches that can be left in the ON position. While the Director does have the ability to send a power-on command to the piece of source gear after applying power to it via the source power receptacle on the rear of the Director, this is yet one more headache that you don't need if you can avoid it. Please note that this feature of the Director only works if there is a power on button on the remote control. And also note that

this machine control feature is the only feature that does not require using one of the 16 machine commands to just do power ON. Please see the Configuration section for more details on using this feature. Speaking of which, with equipment that has mechanical on/off switches located on the front panel, it is important to explain to the client that these should remain in the on position at all times, as the Director will be controlling the power to the sources. While it is not recommended by us, some installers go as far as to open the source equipment and bypass the power switch so that the equipment cannot be turned off by the client. This of course would violate the manufacturers' warranty...

- ④ Try to select sources that revert back to the same known power up state. This is important with sources such as CD players, etc., but not as important or desirable with tuners. While it is a good thing that a tuner remains set to the last station that was listened to, it is not desirable to have a CD player that remembers that it was last in "shuffle one disc" mode when you turn it's power on. Speaking of source behavior upon power up, we have seen some CD players and tape decks that will automatically go into "play" mode if there is a disc (or tape) in them at power up. Using the ability of the Director to send a command to the source at power up allows you to defeat this type of behavior. One caveat is that you can only send one command to the source at power up time. So if the source needs a power-ON command and a stop command, you should go shopping for another source!

Other than the above requirements, pretty much anything goes as far as the choice of source equipment goes. It is recommended that sources of high quality be used, as the Director is capable of high quality sound reproduction with the right source and amplifier components. Also consider the mechanical longevity of such source equipment as CD players and tape machines. The cheap/low end components that are available on the market should be considered disposable, because that is what will have to be done with them in short order!

Dealing with the DSS dragon

Given the appeal of the music channels that are present on DSS today, you may be wondering how you can incorporate DSS control with the home audio system. Easy! Since the Director has 16 machine control commands per source, you can configure them as '0' to '9' as on the remote, 'enter' if needed, 'next' and 'last'. Oh, and 'power on' and 'power off' of course. You can then set up macros for station buttons with the favorite stations preprogrammed, so that pressing a

station preset button send ‘2’ ‘4’ ‘7’ ‘enter’. Instant favorite DSS station. Add in the ‘next’ and ‘last’ macros on the appropriate station buttons and you are the homeowner’s hero.

And then there are the 100+ disc CD changers..... These machines all tend to operate differently. You have idiosyncrasies galore. However, as with the DSS example above, it is quite possible to configure 16 station buttons as say the first 16 CDs, but this gets quite limiting in a hurry. A different approach would be to set up station buttons to access “groups” and “favorite discs” and leave it at that. In reality, the ideal user interface for such a CD changer is a library management system, which ends up costing many times what the consumer pays for the CD machine.

Some comments on FM tuners...

Most installations will have at least one FM tuner. Some things to keep in mind when selecting a tuner are:

- IR receiver or direct control in jack for IR like control.
- FM preset up/down.
- Search up/down.
- Direct selection of presets by number.
- No loss of data when powered down.

Additional Equipment Requirements

In addition to the Director, wall mounted control stations and sources, the only other equipment that is required to complete a basic Director installation is some type of amplifier or amplifiers.

Amplifiers

While each installation will have it’s own requirements and demands as far as amplifier selection goes, we would like to take the time to plug the Director’s companion amplifier product, AudioControl’s Architect Model 1250. This is a complete 6 stereo zone, 50 watt per channel amplification system with the following list of features:

- Bullet-proof Reliability
- 6 Stereo amplifiers with 50 watts per channel output.
- RCA audio inputs.

figure 3.10 The Architect Model 1250

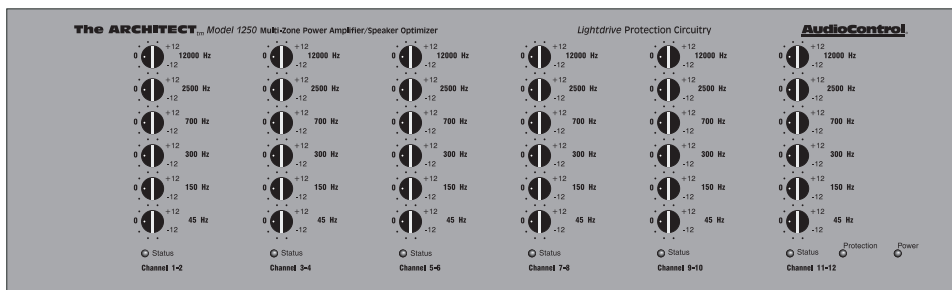

- System pre-wire speaker connectors (12 pin weco connectors).
- Remote turn on via either a control voltage or contact closure (3 pin weco connector).
- Dual-Color Power Status LED (Amber Standby, Green Remote-Trigger ON).
- Dual rail power supply design.
- Discrete output devices.
- Stereo 6 band equalizer, with frequency band centers optimized for use with in-wall speakers.
- Individual channel “Signal Sensing” muting
- Individual zone protection (nothing should shutdown all channels).
- LightDrive Protection Circuitry
- Convection cooling (no noisy fan).
- 5 year warranty.

Additional considerations in choosing amplifiers for use with the Director include (but are not limited to): Can it drive the load that you intend to put on it's outputs? No need to choose an amplifier able to only drive 8 ohm loads when there are going to be four 8 ohm speakers wired in parallel hung off of each output! Does it have sufficient power output to drive the speakers to the required volume levels without distorting? Will there be adequate ventilation and power available for it? Does it have a noisy internal fan, and if so, will the noise be a problem considering where the equipment will be located? These are just some of the issues involved.

Optional Sources - Paging input

The Director supports an external audio source for whole house paging, with a separate control input to signal the Director to transfer all zones to this source. The control input can take the form of a contact closure or a control voltage that can be either 6 to 24 volts AC or 6 to 30 volts DC. The Director does not have any internal capability of generating signaling tones such as simulated doorbells and the like, you will have to provide these types of signals externally. Additionally, the Director requires that a control input be provided to enable the paging when desired. There is no internal provision in the Director for signal activated control. If this is a requirement, an external signal activated relay module will have to be used to provide the control input to the Director. Please note that to a great extent the paging input has been provided for your convenience, but the interfacing requirements are much more of a DIY project than any other aspect of the system. Since the possible signal sources for the paging input are so vastly different, you will need to work this out ahead of time. There is some flexibility built into the configuration of the Director for the paging control input. Please see the Configuration section of the manual for more details.

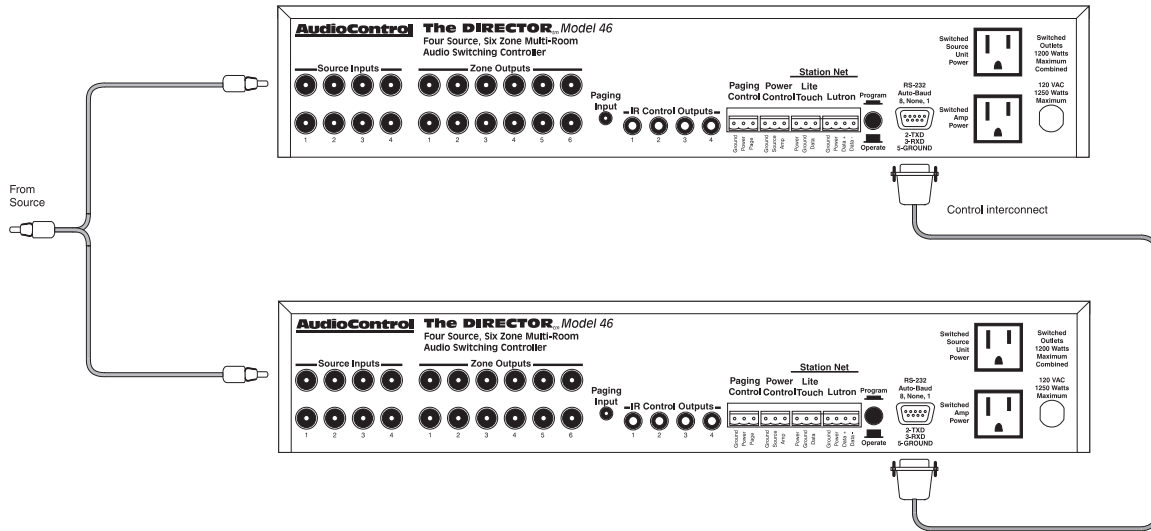

figure 3.11 Audio Y cords for patching the source audio between two interconnecting two Directors.

Interconnecting Two Director Model 46s in an Expanded System

When using two Directors as an expanded system, it is necessary for the two units to communicate. They do this via the RS232 serial port. A null modem cable is used to interconnect the two units. This is a cable that has the transmit data and receive data lines swapped at one end so as to route the transmit data pin from the master Director to the receive data pin on the slave, and vice versa. The cable pin out is given below.

Since the Director doesn't have a set of source loop-thru jacks on the back (what, yet more connectors on an already crowded back panel?), you will need to use some type of custom cabling or Y-cord type device to route the audio signals from the sources to the two Directors. Additionally, the Director that is configured to be the master will be the Director that is providing the IR control codes to the source units. The slave Director will still need to have the stations that are controlling the slave zones connected to the slave Director.

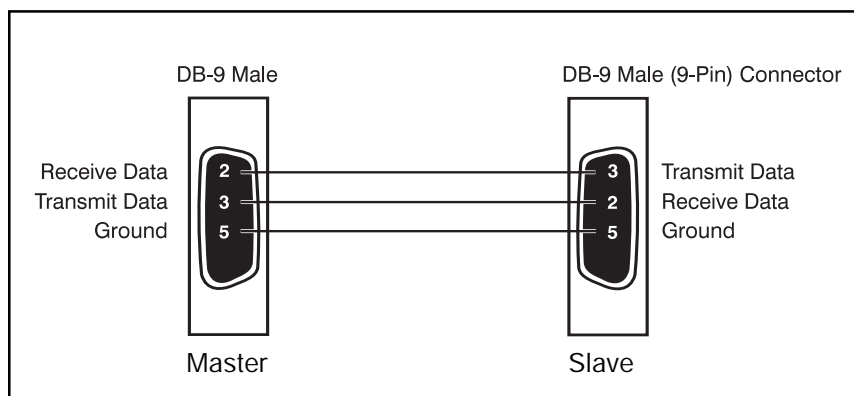

figure 3.12 Control cable for interconnecting two Directors

Using the Director Model 46 with other Home Automation Systems

The Director has been designed from the beginning to allow for integration with other whole house automation systems. The Director may be controlled completely from the RS232 serial port on the rear panel, including all of the macro features found in the standard Director system.

The Director is controlled by the external automation system by sending it button press and button release commands. This causes the Director to execute the macro that has been configured into the Director, in the exact same manner as if this was a button on a physical station. If you desire, you can even use the same addresses as physical stations connected to the system, and the Director will respond to these commands in the same manner as pressing the button.

The Director sends back an acknowledgement (OK) after it has completed the macro that is assigned to the pressed button. If the command was invalid, the Director returns an ERROR message.

The status of each station may be retrieved from the Director by sending it a station query message. The status that is returned is the state of each station button LED (on or off - 1 or 0).

The complete command set and all the details for using this feature are in appendix I.

When using 2 interconnected Directors with an external automation system it will be necessary to make provisions in the automation system for transparent message passing between the two Directors. In addition, the automation system will need to be able to interject its button press commands into the proper Director when it wishes to exert control over the audio system. Please also note that the IR control for the sources is done by the master Director and that the slave Director will be passing machine commands to the master Director.

Special note: When using an expanded Director system with an external home automation system: Normally an expanded Director system consists of two Directors interconnected via their RS232 ports. When using an expanded Director system with an external automation or control system, the two Directors will have to be connected to the external system via their RS232 ports, precluding the normal interconnection.

Configuring A System

The Director is a dual-mode system. By this we mean that the Director has two modes of operation, which are the normal operating mode, used in the day to day operation of the system by the homeowner; and the configuration mode which is used only by you, the installer. Switching between the two modes of operation is performed by pressing the program switch on the rear panel of the Director located next to the RS232 connector. When the Director system is in the normal operating mode, the RS232 serial port can be used by an external control system for sending control commands to the Director. When the Director is in the configuration mode, the RS232 port is used with a communications program running on a PC for setting the various configuration options of the Director. All normal operation of the Director is suspended when in configuration mode. There are diagnostics that are used to troubleshoot various aspects of the installation and these could give misleading or invalid results if someone was trying to play music in another location with the system.

Manual Conventions

A brief note concerning the presentation of the configuration section. All text that appears on the screen of your computer will be shown using the Courier typeface, with menu and sub menu titles and current values displayed in **bold Courier**. When specific keys on your computer keyboard are spelled out, they will be in bold face type and surrounded by brackets such as **[Enter]** which translates to pressing the 'Enter' key on the keyboard.

What is meant by Configuration?

Configuring the Director 46 is simply the entry of the various details of the system design into the Director. The configuration menu system built into the Director makes this task as simple as filling in a few forms with the required information.

What are Macros?

A macro is a sequence or set of steps that the Director goes through in response to an external event such as a button press on a control station or a command from an external controller. Macros may be built up by defining the set of steps that are to occur on the press and hold or release of a station button using the built-in macro editor.

Factory Default Configuration

We have shipped the Director pre-configured from the factory with a specific selection of sources chosen to work along with a default set of macros assigned to a default set of station addresses and station buttons. You can change this in any way that you desire, or erase it completely. We hope that you will find the presence of the factory defaults useful, if for no other reason than to allow you to test a Director installation without having to worry about configuring the system from scratch before the installation. We've all experienced the situation of installing a system, then having to program it, and not being sure of where the problem may be when things don't work as expected. Is it in the wiring? Is it in my configuration? By having the default factory configuration present, a simple check of an installation can be made before you start to worry about what you want the system's final configuration to be. See Appendix L for a complete description of the factory defaults.

Connecting the Director to a Computer

The Director may be connected to a PC for system configuration and to test the configuration when using the Director with another automation control system. This explanation assumes that the user is familiar with their terminal emulation software and has the terminal software configured for ANSI, ANSI-PC or VT100 emulation, 8 data bits, 1 stop bit and no parity bit. Baud rate may be set anywhere between 300 baud and 38400 baud, we recommend that for best results and response time, that you use a baud rate

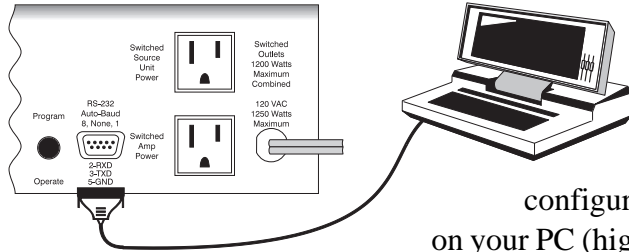

of 19200 baud (use 38400 baud only if your PC has a 16550 UART on the serial port and your comm package supports this feature, otherwise you may have missing characters in the screen display). If you expect to use the upload/download

configuration options to save the configuration data to disk on your PC (highly recommended), then it will be necessary to make sure that your communications package fully supports the Zmodem protocol, including the remote naming feature. The Director is connected to the PC by way of the serial port connector on the rear panel. The Director will automatically detect the baud rate that the terminal software on your PC is configured for. Entry to the configuration mode requires that the button located to the left of the serial port connector on the rear of the Director be in the IN position. Once this is done, tap the space bar on the computer's keyboard. It should not be necessary to tap the space bar more than once (if the Director doesn't respond after the first press of the space bar, you may need to check all of your configurations on your communications software and the cabling and start over). The Director will respond with an opening screen that looks like this:

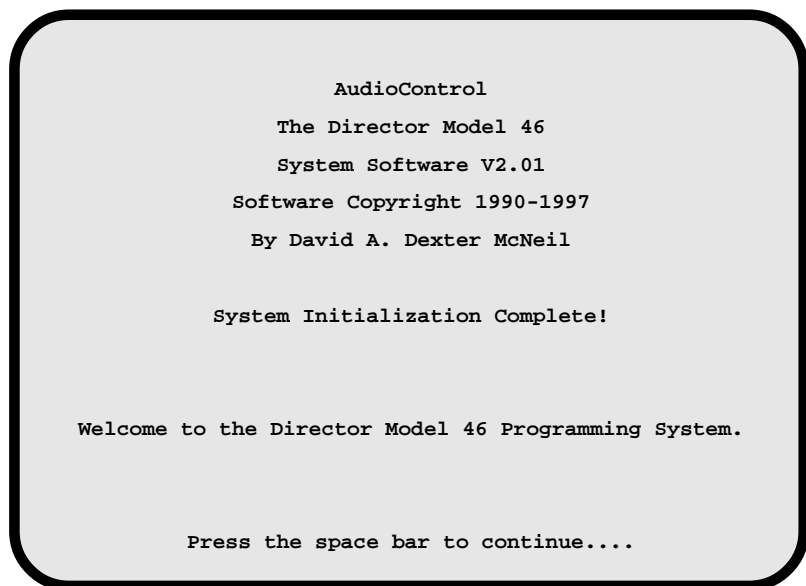

At this point the Director is ready for you to configure. Press the space bar to get to the main menu. Below is a quick summary of the various menus and sub menus, after which there is a detailed breakdown of each menu item and an explanation of the item. While most of this should be straight forward, and no more complicated than filling in a form should be (well, most forms anyway, IRS specifically excluded!), we advise that the first time that you configure a Director system, it be done in a relaxed environment, with the system and manual in front of you and no clients breathing down your neck. If possible, try to have a couple of stations connected, and a source or two to work with. And now, on to the explanations.

Menu Overview

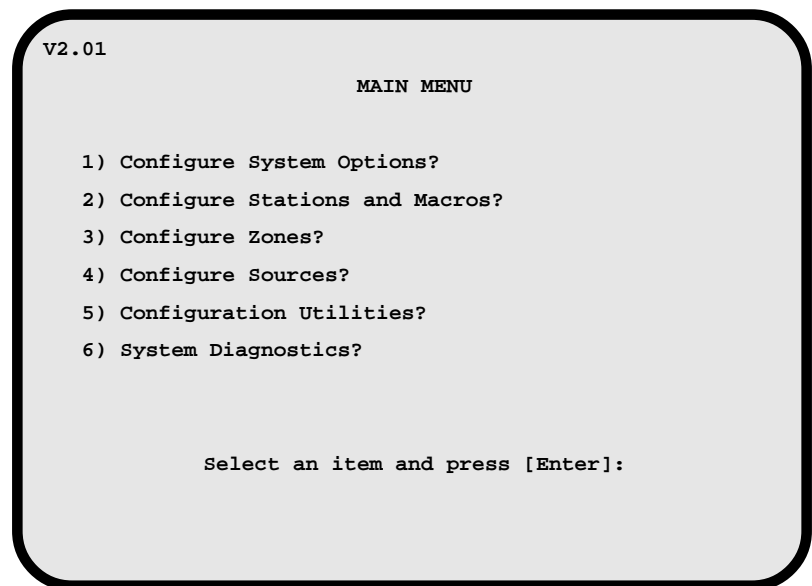

First thing to note is that the software version number appears in the upper left hand corner of the display, and in this case is V2 . 01 (version 2.01). The software version number will appear on all of the menu screens. If you need to discuss any questions or problems with AudioControl concerning the Director, we will need to know the software version that you are working with, so please take note of this number when calling us.

This is the first menu that you will see after the opening screen. Each of the various subsections can be accessed from this menu, and each subsection will have it's own set of menus. To get to a menu level, press the number next to the menu item and press the **[Enter]** key.

Selecting item 1 from the main menu will take you to the sub menu that has the various global system configuration options:

```
V2.01

          Configure System Options

1) Change power up sequence timing?          [total 6 seconds]
2) Configure external control via serial port? [not configured]
3) Configure Source Deselect Timer?          [ 15 minutes]
4) Set auto-off timer?                        [ 30 minutes]
5) Configure external paging input options?
6) Interconnect two Directors?                [no]

          Select an item and press [Enter]:
          [Esc] to return to MAIN MENU.
```

This sub menu contains the global system default options and should be the first place that you go to.

In this sub menu, you can see what the current configurations have been set to for various system configuration options, illustrated with the highlighted text. On your computer screen, these items will appear as either highlighted or in a different color, depending on how your communications program deals with displaying highlighted text.

Note that underneath the prompt `Select an item and press [Enter]:` is a second prompt `[Esc] to return to MAIN MENU.` The `Select an item` prompt is how you select a menu item, while the escape prompt is where you will be returned to if you press the `[Esc]` key. For this menu, the `[Esc]` key returns you to the main menu.

Selecting item 2 from the main menu will take you to the configure stations sub menu:

```
V2.01      Configure Stations and Macros
           Currently programmed station addresses:
01 - Factory default      09 - Factory default
02 - Factory default      10 - Factory default
03 - Factory default      11 - Factory default
04 - Factory default      12 - Factory default
05 - Factory default      13 - Factory default
06 - Factory default      14 - Factory default
07 - Factory default      15 - Factory default
08 - Factory default      16 - Factory default
EDIT OPTIONS:
1) Add a new station?
2) Change address of station?
3) Edit a station's macros?
4) Copy macros from one station to another?
5) Delete a station and all of it's macros?
   Select Edit option and press [Enter]:
                               [Esc] to return to MAIN MENU.
```

The station and macro configuration sub menu is used to enter station addresses and to create and edit station button macros. The above display shows the factory default configuration, with the 16 factory default station addresses entered.

Selecting item 3 from the main menu will take you to the configure zones menu:

```
V2.01
           Configure Zones

1) Split a zone?
2) Set min/max/default/mute volume levels for a zone?
3) Select Last/Default volume for a zone?
4) Set left/right balance for a zone?
5) Set bass/treble levels for a zone?

           Select an item and press [Enter]:
                               [Esc] to return to MAIN MENU.
```

This sub menu is contains the zone related configuration options. All stereo/mono, volume level, bass and treble, and balance settings are configured with the options in this menu.

Selecting item 4 from the main menu will take you to the configure sources sub menu:

```
V2.01

                          Configure Sources

1) Select source manufacturer and type?
2) Edit machine control function assignments for a source?
3) Set input gain level?
4) Set machine control via IR or direct in?
5) Set machine control delays?
6) Set command sent when source deselected?
7) Set command sent at source power up?
8) Download new IR code?

                          Select an item and press [Enter]:
                          [Esc] to return to MAIN MENU.
```

Source configuration options are located here. Selecting the type of source and the manufacturer are necessary for the IR control links, along with configuring the machine commands for use in the station button macros.

Selecting item 5 from the main menu will take you to the configuration utilities sub menu:

```
V2.01

                          Configuration Utilities

1) Download configuration to external computer via serial port?
2) Upload configuration from external computer via serial port?
3) Clear all configuration information?
4) Restore factory configuration?

                          Select an item and press [Enter]:
                          [Esc] to return to MAIN MENU.
```

The utilities to save and restore your configuration information with an external computer, clear all of the system configuration information, and restore the factory default configuration are in this sub menu.

Selecting item 6 from the main menu will take you to the system diagnostics sub menu:

```
V2.01

                          System Diagnostics

1) Test station network and report all stations found?
2) Interactive station identification?
3) Test audio path of a zone?
4) Machine control test?
5) Paging subsystem test?
6) Turn on/off source power?[off]
7) Turn on/off amp power?  [off]

                          Select an item and press [Enter]:
                          [Esc] to return to MAIN MENU.
```

The system diagnostics section of the manual contains diagnostic and troubleshooting tools for use in getting a Director system installed and up and running.

Configuring System Options

```
V2.01

          Configure System Options

1) Change power up sequence timing?          [total 6 seconds]
2) Configure external control via serial port? [not configured]
3) Configure Source Deselect Timer?          [ 15 minutes]
4) Set auto-off timer?                        [ 30 minutes]
5) Configure external paging input options?
6) Interconnect two Directors?                [no]

          Select an item and press [Enter]:
          [Esc] to return to MAIN MENU.
```

There are six different system option areas for the Director. They are:

- 1) Change power up sequence timing? [total 6 seconds]

This is the total delay time that the Director waits from the time the POWER ON macro element is executed. The delay time is divided into two delays, one for sources and one for amplifiers. Entering this menu item will get you the following display:

```
V2.01

          Change power up sequence timing

Current wait for source delay set for:      [ 3 seconds]
Current wait for amplifier delay set for: [ 3 seconds]

Enter new source delay time [0 to 60 seconds, Enter to skip]:

          Press [Enter] when finished, [Esc] to quit.
```

The current delay time settings for both the source delay and the amplifier delay. The source delay is the time that the Director waits after it applies power to the source receptacle (and the corresponding control output). After the source delay expires, the Director applies power to the amplifier receptacle (and the corresponding control output). The amplifier delay is the time that the Director waits after applying power to the amplifier receptacle before continuing on with the rest of the macro configured on the station button that was pressed.

In the above display, we see that we are being prompted to enter a new delay time. We can skip over the source delay, leaving it set as is, or enter a new value for the delay time. After entering the source delay time, the display will change and we will get another display which is:

```
v2.01
```

```
Change power up sequence timing
```

```
Current wait for source delay set for: [ 3 seconds]
```

```
Current wait for amplifier delay set for: [ 3 seconds]
```

```
Enter new source delay time [0 to 60 seconds, Enter to skip]: 5
```

```
Enter new amplifier delay time [0 to 60 seconds, Enter to skip]:
```

```
Press [Enter] when finished, [Esc] to quit.
```

After entering the new amplifier delay time (or skipping over it), you will be returned back to the Configure System Options menu.

2) Configure external control via serial port?
[not configured]

This sub menu allows you configure the options associated with using the Director with an external control system. In the Configure System Options sub menu, menu item two shown above also indicates that the serial port isn't configured for external control. Selecting this item gets you another sub menu:

```
V2.01
      Configure external control via serial port

1) Set Baud rate of serial port?   [not configured]
2) Enable phantom station configuration? [disabled]

      Select an item and press [Enter]:
      [Esc] to return to previous menu.
```

This sub menu has two options on it. The two options are interlocked, in that selecting the baud rate for the serial port also enables the phantom station configuration (external station button presses via the serial port). When you enter menu item 1, you will be shown the current baud rate and prompted to change it if so desired. The display will be:

```
V2.01
      Set Baud rate of serial port

      Current Baud rate is: [not configured]

1)38400 2)19200 3)9600 4)4800 5)2400 6)1200 7)600 8)300

      Select new Baud rate from the list by entering number next
      to rate:
      Press [Enter] when finished, [Esc] to quit.
```

The currently selected baud rate is displayed in the brackets, along with a list of possible choices. To change the baud rate, enter the number that corresponds with the desired baud rate. You may exit without changing the setting by pressing the [Esc] key. After entering the new baud rate you will be returned to the previous menu:

```
v2.01
      Configure external control via serial port

1) Set Baud rate of serial port?      [19200 baud]
2) Enable phantom station configuration? [enabled]

      Select an item and press [Enter]:
      [Esc] to return to previous menu.
```

In the above menu, a baud rate of 19200 baud was selected. Upon selection of the baud rate, the phantom station configuration option is enabled. This is simply a way to turn on and off the external control without changing the baud rate to disable it. Selecting item 2 on the above menu will toggle the state of the external control. The baud rate setting will not be lost even though when the external control is turned off it indicates that it is not configured.

3) Configure Source Deselect Timer? [15 minutes]

The source deselect timer is started whenever a previously selected (and active) source has been either deselected (is not playing in any zone), or when all of the zones that the source was selected in have been muted. When the timer expires, a machine command (chosen in the Configure Sources menu) is sent to the source. This is typically used to send a STOP command to a CD or tape player so that when the homeowner has decided to listen to the FM tuner for the rest of the day, the CD player doesn't continue to play every disk in the changer. There are four deselect timers, one for each source, with a common timeout value.

Choosing this menu item will get you the following display:

```
V2.01  
  
          Configure Source Deselect Timer  
  
Current Source Deselect Timer set for: [ 15 minutes]  
  
Enter new deselect timer wait time [0 to 60 minutes, 0= disable]:  
          Press [Enter] when finished, [Esc] to quit.
```

Upon entering the new deselect time you will be returned to the Configure System Options menu.

4) Set auto-off timer? [30 minutes]

This is where the auto power off timer can be changed. Upon selection of this menu item, you will see the following prompt:

```
V2.01  
  
          Set auto-off timer  
  
Current Auto Off time set for: [ 30 minutes]  
  
Enter new power off timer wait time [0 to 60 minutes, 0 =  
disable]:  
  
          Press [Enter] when finished, [Esc] to quit.
```

At this point you can enter the time that the system should wait after it detects all zones in mute before it shuts down the system. If the time is entered as 0, then the timer is disabled.

When the auto-off timer expires it will: Mute the audio to all the zones, turn off the power to the amplifiers, send any deselect commands to their respective sources if configured, and then remove power from the sources. Finally, it will update the led status to all the stations.

5) Configure external paging input options?

The external paging input has a number of configuration options that can be set. Upon entry to this sub menu the choices are:

V2.01

Configure external paging input options

- 1) Set minimum closure duration? [.2 seconds]
- 2) Set minimum open duration? [.2 seconds]
- 3) Set maximum page time? [2 seconds]
- 4) Page in muted zones? [disabled]
- 5) Set/View zone page level?

Select an item and press [Enter]:

[Esc] to return to previous menu.

1) Set minimum closure duration: [.2 seconds]

This option may be used to set the minimum continuous time that the paging control input must be present before the Director will switch to the paging audio input. The idea behind this was to help eliminate false triggers due to bad contacts in an external switching circuit. Upon entry to this item the following prompt will appear:

```
v2.01

          Set minimum closure duration

Current closure duration time: [ .2 seconds]

          Enter minimum closure duration:
[0 to 2 seconds, increments of .1 second, NO DECIMAL POINT!]
          Press [Enter] when finished, [Esc] to quit.
```

At this point you may enter the minimum time the trigger must be present. The current minimum closure time is shown in highlighted text. You can enter any time from 0 seconds to 2 seconds, in 1/10th of a second increments. Note that an entry of 0 will disable the minimum closure timer feature.

2) Set minimum open duration: [.2 seconds]

The minimum open duration is similar to the minimum closure duration. The currently set time is displayed in highlighted text. This is the minimum time that the page input must remain open before the system will revert back to normal operation and the paging trigger input will be reset. Again this is to assist in the elimination of false triggers because of bad external control inputs.

V2.01

Set minimum open duration

Current open duration time: [.2 seconds]

Enter minimum open duration:

[0 to 2 seconds, increments of .1 second, NO DECIMAL POINT!]

Press [Enter] when finished, [Esc] to quit.

At this point you may enter the minimum time the trigger must be removed for before normal operation is restored. The current minimum open time is shown in highlighted text. You can enter any time from 0 to 2 seconds, in $\frac{1}{10}$ th of a second increments. Note that an entry of 0 will disable the minimum open timer feature.

3) Set maximum page time: [20 seconds]

This option allows you to limit the duration of the page, if so desired. The current value is displayed in the brackets. The purpose was to allow the Director to limit the length of disturbance that the paging input may present. Upon entry to this item you will be prompted for the value to enter:

V2.01

Set maximum page time

Current maximum page time is: [2 seconds]

Enter maximum page duration [0 to 180 seconds]:

Press [Enter] when finished, [Esc] to quit.

At this point you may enter the maximum time that a page input will be allowed to be heard. The current maximum page time is shown in highlighted text. You may enter any time from 0 to 180 seconds, in increments of 1 second. Note that an entry of 0 will disable the maximum page timer feature, allowing a continuous page if so desired.

4) Page in muted zones? [disabled]

This option allows you to configure how the Director deals with situations when the system is powered up, but some zones are still muted. Each zone can be set to page through mute individually. If any one or more of the 6 zones are enabled, this menu line's status will show [enabled] in the highlighted text. If all 6 zones are disabled, this menu line's status will show [disabled] in the highlighted text. Upon entry to this sub menu, you will see:

```
V2.01
                                     Page in muted zones

1) Zone 1: [disabled]
2) Zone 2: [disabled]
3) Zone 3: [disabled]
4) Zone 4: [disabled]
5) Zone 5: [disabled]
6) Zone 6: [disabled]

Select a zone [1 to 6]:
    Press [Enter] when finished, [Esc] to quit.
```

Typing a zone number (1-6) and pressing the **[Enter]** key will toggle the enable/disable configuration for that zone, and the display will update to reflect the change in status. The display shows in highlighted text the current configuration status of this feature for each zone.

5) Set/view zone page level?

The volume level of the page signal may be set on a zone by zone basis. There are several ways to set this up. They are: a) Use current volume level of zone when zone is playing, or use the default/last volume when zone is muted if 'page through mute' is enabled for the zone; b) Use mute volume for page signal. Note that this is pointless if the mute volume has been selected to be all the way off; c) Set a separate volume level for the page signal in the zone; d) A level below but relative to the current level. Upon entry to this item you are presented with the following choices:

👉 IMPORTANT

NOTE: The above values are the real factory defaults. Given the large number of possible paging applications we felt it best to offer a safe default, which in this case forces you to specifically go and set the levels. Much better than blowing up speakers, right?

V2.01

Set/View zone page level

- 1) Zone 1: [use mute level]
- 2) Zone 2: [use mute level]
- 3) Zone 3: [use mute level]
- 4) Zone 4: [use mute level]
- 5) Zone 5: [use mute level]
- 6) Zone 6: [use mute level]

Select a zone [1 to 6]:

Press [Enter] when finished, [Esc] to quit.

This sub menu shows you the current page volume level settings for each of the 6 zones. Typing a zone number followed with the **[Enter]** key will get you an entry screen that will allow you to set a new page level for that zone. For example, we'll pick zone 1:

V2.01

Set/View zone page level

Current level for zone 1 is: [use mute level]

Enter page level in dB:

Press [Enter] when finished, [Esc] to quit.

Acceptable range is 0 to -78.75db, in increments of -1.25db, or

C to use current level.

M to use the mute level.

R followed by a level relative to the current level.

Relative levels are below current levels only.

So what does all of this mean? Well, in the menu display above, the top line is telling us which sub menu we've descended to, in the same way as in all of the other sub menus. The second line is telling us that the current page level setting for zone 1 is to use mute level, which means that the Director will use the volume level that has been set for when zone 1 is muted. The third line is asking for a new input level. The fourth line is explaining how the level can be set, and what it's range is. The Director uses a special volume level control circuit which has a range of 0 (full volume) to -78.75db (almost muted), and this volume range is divided up into steps of 1.25db. Now before you start reaching for your calculator to translate a particular level into the nearest acceptable input... don't worry. The Director will accept any volume level between 0 and -79db, and will convert it to the nearest level with an increment of 1.25db. For example, if you entered 42, the Director would convert that to -41.25db. And you don't have to enter the '-' sign, or a decimal point, the Director will accept the numbers that you type, converting them to the appropriate level, as long as they are within the acceptable range of 0 to 79. In addition, there are three other options for page volume level. The 'C' option sets the Director to use the current volume level in the zone, or the last/default volume level (see the section on setting last/default volume levels under Configure Zones) if the zone is muted and the page through mute option is enabled for that zone. The 'M' option allows you to use the mute level, which is settable separately, and can be anywhere between 0db (could be louder than the current level!) to complete off. Obviously, it makes no sense to program a page level to use the mute level for a zone that is set up with off as a mute level, unless you never want to hear the page in that zone. The 'R' option allows you to set the page level as a constant level below (relative to) the current zone volume level. Relative levels are only allowed to be below the current zone's volume level, which means that the page level cannot be set above the current volume level using the relative mode.

6) Interconnect two Directors? [no]

When it is desired to expand the number of zones that a Director system controls beyond the 6 zones available in a single Director Model 46, you can interconnect two Directors by interconnecting the serial ports. When this is done, it is necessary to tell both Directors that they are interconnected and also configure one Director as a master which will be zones 1 to 6, and the other Director as a slave which will be zones 7 to 12. Please note that the slave Director will still have an internal view of it's zones as being numbers 1 to 6, for the purposes of configuring the slave zones. When you enter this menu item you will be asked if you want to do so:

v2.01

Interconnect two Directors

Interconnect two Directors [no] :

Press [Enter] when finished, [Esc] to quit.

Enter either a Y for yes or an N for no. If you enter an N, you will be returned back to the previous menu, as there is no need to go any further with configuring this option if two Directors are not being interconnected. If you answered Y, then you will be presented with the master/slave configuration option.

You need to tell the Director if it is the master or the slave. The difference between the master and the slave is subtle but important. The master unit is responsible for machine control and tracks the status of the system as a whole. The slave is only responsible for the source selection and zone control for zones 7 to 12. Also note that power control for the amplifiers for zones 7 to 12 is still handled by the slave as well. So the next configuration question asked is:

v2.01

Interconnect two Directors

This unit configured to be the [slave]

M to configure this Director as the Master, S for Slave:

Press [Enter] when finished, [Esc] to quit.

Enter either an M for master or an S for slave. After telling the Director what it's place in life is going to be, you will be returned to the Configure System Options menu.

This completes all of the options and their configuration menus for the global system configuration parameters. Now might be a good time to take a quick break!

Configuring Stations and Macros

This sub menu contains all of the station and button macro related configuration options. The one that may be the most interesting (and provides for the most rope to hang oneself with) is the macro editor. Upon entry to this sub menu you will see the following display:

```
V2.01          Configure Stations and Macros
  Currently programmed station addresses:
01 - Factory default      09 - Factory default
02 - Factory default      10 - Factory default
03 - Factory default      11 - Factory default
04 - Factory default      12 - Factory default
05 - Factory default      13 - Factory default
06 - Factory default      14 - Factory default
07 - Factory default      15 - Factory default
08 - Factory default      16 - Factory default

  EDIT OPTIONS:
1) Add a new station?
2) Change address of station?
3) Edit a station's macros?
4) Copy macros from one station to another?
5) Delete a station and all of it's macros?
Select Edit option and press [Enter]:
                               [Esc] to return to MAIN MENU.
```

This display is an expanded version of the standard menu display. Shown above are the 16 station addresses that are part of the factory default configuration (hence the label Factory Default). Below the station display are the five menu options along with the standard menu choice entry prompt.

1) Add a new station?

This menu option allows you to add station addresses. You must tell the Director the address (set on the address switches of the station) that you are going to add before you can configure the macros on the buttons. The Director supports a maximum of 16 stations, so if you were to try to add a station to the above 16, the Director would respond with the following error message:

```
V2.01          Configure Stations and Macros

  Currently programmed station addresses:

01 - Factory default      09 - Factory default
02 - Factory default      10 - Factory default
03 - Factory default      11 - Factory default
04 - Factory default      12 - Factory default
05 - Factory default      13 - Factory default
06 - Factory default      14 - Factory default
07 - Factory default      15 - Factory default
08 - Factory default      16 - Factory default

EDIT OPTIONS:

  All station positions are full!

  Please delete a station assignment if you wish to add
  another station.

                          Press [Esc] to exit.
```

In the display below, there are only 15 stations so we have room to add another station. We are being prompted for the address of the new station. The display looks like this:

```
V2.01          Add a new station

  Currently programmed station addresses:

01 - Factory default      09 - Factory default
02 - Factory default      10 - Factory default
03 - Factory default      11 - Factory default
04 - Factory default      12 - Factory default
05 - Factory default      13 - Factory default
06 - Factory default      14 - Factory default
07 - Factory default      15 - Factory default
08 - Factory default

Enter station address:

                          Press [Enter] when finished, [Esc] to quit.
```

We are going to enter station address 16 to the system. After entering the new station address and pressing return, we will see the following display:

```
V2.01          Configure Stations and Macros
  Currently programmed station addresses:
01 - Factory default      09 - Factory default
02 - Factory default      10 - Factory default
03 - Factory default      11 - Factory default
04 - Factory default      12 - Factory default
05 - Factory default      13 - Factory default
06 - Factory default      14 - Factory default
07 - Factory default      15 - Factory default
08 - Factory default      16 - User defined

EDIT OPTIONS:
1) Add a new station?
2) Change address of station?
3) Edit a station's macros?
4) Copy macros from one station to another?
5) Delete a station and all of it's macros?

      Select Edit option and press [Enter]:
      [Esc] to return to MAIN MENU.
```

We now have a new station added to the system, and as it shows this is a station that we are defining and not part of the factory default. Also note that if you edit an existing factory default station configuration the display for that station address will also show it as a User defined station configuration.

2) Change address of station?

OK, so you have a station that doesn't seem to work, so you run the Test station network and report all stations found diagnostic located in the System Diagnostics menu, and it reports back that there is a station address that is not entered into the system. Coincidentally, there is also one station address missing from the list of stations that were found. The station that isn't working. So what do you do? Well you could remove the station from the wall and change the address switch to the correct station number, but since Murphy's law is always in operation, this happens to be the station that was a little difficult to get into it's back box for some reason. This menu item allows you to reassign the address of a station without losing all of the macros that have been entered for the station. Upon entry to this menu item you will see the following display:

```
V2.01          Change address of station
Currently programmed station addresses:

01 - Factory default      09 - Factory default
02 - Factory default      10 - Factory default
03 - Factory default      11 - Factory default
04 - Factory default      12 - Factory default
05 - Factory default      13 - Factory default
06 - Factory default      14 - Factory default
07 - Factory default      15 - Factory default
08 - Factory default      16 - User defined

Enter existing station address to change:

Press [Enter] when finished, [Esc] to quit.
```

So now we enter the address of the station that is missing, which in this case is station 01. We then get the following display:

```
V2.01          Change address of station
Currently programmed station addresses:

01 - Factory default      09 - Factory default
02 - Factory default      10 - Factory default
03 - Factory default      11 - Factory default
04 - Factory default      12 - Factory default
05 - Factory default      13 - Factory default
06 - Factory default      14 - Factory default
07 - Factory default      15 - Factory default
08 - Factory default      16 - User defined

Enter existing station address to change: 01
Enter new address for station:
Press [Enter] when finished, [Esc] to quit.
```

The display shows us the station address we are about to change and is asking us for the new address for that station. So we enter the actual address that the station is set to and press enter. We will be returned to the Configure Stations and Macros menu with the new station address displayed in the same position as the old address of station 01. Problem solved!

3) Edit a station's macros?

All buttons must have a macro assigned to them in order for them to do anything. The macros are the central point of the Director system, allowing you to define what the system does in response to a station button press. A macro is simply a sequence of valid Director commands or elements, appearing in the order in which they are to be executed. You use the macro editor to enter and modify the element assignments in a macro. A complete list of the available macro elements with a description of what each element does is listed in Appendix I.

Each station button has two modes of operation. The first mode is the normal, expected press/release type of operation where the user has desired to select something such as a source. The second mode is the press and hold operation. Typically the press and hold is used to raise and lower volume, or to provide a second extended function such as the next disc (press and hold) vs. next track (press and release) on a CD player.

A macro is a series of steps, appearing in order of execution. Each step is referred to as a macro element. The Director has room for 24 macro elements per station button, divided between the press/release and press/hold button actions, with up to 9 buttons per station. If the press/release macro only consumes 6 steps, this will leave 18 steps for the press/hold macro, and vice versa.

One thing that we need to stress here is that you need to have a clear idea of what you want the system to do when the button is pressed. If you've done this kind of thing before you will know what we mean. If not, we'd like to suggest a simple exercise. Sitting in front of a conventional stereo system with a pad of paper and a pencil, go through the normal set of steps that you need to do to turn on the system and play a source, say a CD player. Every time you touch a knob or switch, write down what you touched and what you did with it. It is these same types of steps that you have to use to build a macro for a button.

So, choosing the macro editor option from the Configure Stations and Macros menu, you are prompted for the station address to enter in the following display:

```

V2.01

                Edit a station's macros

    Currently programmed station addresses:

01 - Factory default      09 - Factory default
02 - Factory default      10 - Factory default
03 - Factory default      11 - Factory default
04 - Factory default      12 - Factory default
05 - Factory default      13 - Factory default
06 - Factory default      14 - Factory default
07 - Factory default      15 - Factory default
08 - Factory default      16 - User defined

    Select station to edit

    Enter station address:

    Press [Enter] when finished, [Esc] to quit.

```

After entering the address, you will see a display of the current status for both the press/release and press/hold macros assigned to each button. You will be prompted for the button to edit. The display looks like this:

```

V2.01          Select Button and macro type to edit

    Current macro status for station: 02

    Press and release macros Press and hold macros

    Button 1: [user macro]      Button 1H: [not configured]
    Button 2: [user macro]      Button 2H: [user macro]
    Button 3: [user macro]      Button 3H: [not configured]
    Button 4: [user macro]      Button 4H: [user macro]
    Button 5: [user macro]      Button 5H: [user macro]
    Button 6: [user macro]      Button 6H: [user macro]
    Button 7: [user macro]      Button 7H: [user macro]
    Button 8: [user macro]      Button 8H: [user macro]
    Button 9: [user macro]      Button 9H: [user macro]

    Enter the button number:

    Press [Enter] when finished, [Esc] to quit.

```

In the above display you can see that some buttons have press/release macros assigned but no press/hold macros and other buttons have both types of macros. When entering a button number for a press/release macro, you simply enter the button number. To access the press/hold macro for the button, you need to follow the button number with the letter h (either upper or lower case). After selecting the desired button number (we will use button 1, press/release for the next example) you will enter the macro editor.

MACRO EDITOR

So to edit a macro assigned to a station button, either one of the factory copies, or a user defined macro, you enter the button number and press **[Enter]**. The Director will then put you into the Macro Editor, which will allow you to configure the macro steps, adding the necessary elements to the macro to make up the desired system function that the station button represents. At this time we would like to remind you of a limitation with regards to macro size. Each station button has two different types of button presses associated with them. Each station button also has room for a total of 24 macro steps, which is the combined total of steps in the press/release and press/hold macros. If you choose to program a press/release macro 10 steps long, you will have 14 steps remaining in which you can define the press/hold macro for that button.

Quick Note: Why is this macro written this way? In the factory default configuration zones 1 and 2 are set up for common source select for the zones with individual volume and mute control. The intention is to use zones 1 and 2 for two adjacent rooms that are open to each other. In this instance it would be undesirable for different sources to be playing in the two rooms, as Rock and Bach will tend to clash. This type of configuration is just one of many things that you can configure a Director system to do.

The display shown below is the macro editor display.

```
V2.01      Assign/Edit macro assigned to a station button
           Press and release macro for Station 02 button 1 is:
1: System power on      2: Zone 1 Source 1      3: Zone 2 Source 1
4: Zone 1 unmute        5:                               6:
7:                      8:                               9:
10:                    11:                    12:
13:                    14:                    15:
16:                    17:                    18:
19:                    20:                    21:
22:                    23:                    24:

           Macro Elements
Unmute - generic      Button LED on      Button LED off
Mute all zones        Unmute all zones  System power on
System power off      Source power on   Source power off
Amp power on          Amp power off     mutually exclusive
Zone 1 volume up     Zone 1 volume down Zone 1 mute toggle
Zone 1 unmute        Zone 1 treble up  Zone 1 treble down
Zone 1 bass up       Zone 1 bass down  Zone 1 left vol up
Zone 1 right vol up  Zone 1 left vol dwn Zone 1 right vol dwn
COMMANDS: I-insert D-delete N-next page P-previous page
[Enter] add element to macro S-save macro
[Esc] Return to previous menu
```

So what does this all mean? Well, on the second line of the display we are showing you the station address that you working with, and which button this macro is for. We are also showing you that this is a press/release macro. The macro editor has two display areas, the macro being edited which is shown on top, and a partial display of the list of macro elements that you can choose from. Looking at the top half of the display, which is showing the macro steps, starting with step 1 S1: System power on which means that if the system isn't already powered up, go through the power up sequence, with the predefined power on delays for the source and amplifier power (see above, in Configure System Options. for how you go about setting the delays). To the right of step 1, is step 2 S2: Zone 1 Source 1 which is the element that selects source 1 for zone 1. Step 3 S3: Zone 2 Source 1 is the element that selects source 1 for zone 2.

The final step in this macro, Step 4 S4: Zone 1 unmute unmutes zone 1, allowing the user to hear the audio from source 1 in zone 1.

Below the button macro display is the Macro Elements display window, which shows a partial list of the available macro elements. When this list is highlighted you can scroll through the list of elements until you get to the desired element.

Editor keys and commands

The available editor commands are different depending on which window is currently active. The available editor commands are highlighted along with the active window.

In addition to the editor commands displayed on the screen below the Macro elements window, there are a few additional keys that are used to move between windows and around in the windows. The functions of the various keys and commands are as follows:

The [Tab] key switches you back and forth between the two areas. The window that is highlighted (bold display) is the active window in which you can move the reverse video cursor around with the arrow keys.

The Arrow Keys move the reverse video block cursor around in the current window. If the cursor is at the bottom (or top) of the Macro Elements window, the next press of the down (or up) arrow key will cause the window to scroll displaying the next (or previous) group of three elements.

I(insert) - Insert a macro element at the current macro step. The normal operating mode is to overwrite the current macro element with the new desired element. Putting the editor into insert mode (indicated by the I-insert label changing to highlighted reverse video) will allow you to add elements to the middle of a macro. When you change windows to the Macro Element window, if you are in insert mode the I-insert label will remain in reverse video, although it won't be highlighted. This command affects only the top button macro edit window.

D(elete) - Deletes the macro element under the cursor. This command affects only the top button macro edit window.

N(ext page) - Scrolls the Macro Elements window forward by one page.

P(revious page) - Scrolls the Macro Elements window backward by one page.

S(ave) - Saves the edited macro to the Director's EEPROM configuration memory.

[Enter] - Copies the currently selected macro element from the bottom Macro Element window (which must be active or highlighted) to the currently selected macro element slot in the upper button macro display window.

[Esc] - Exits the macro editor returning you to the previous button selection display.

4) Copy macros from one station to another?

This menu item does just what it says - allows you to copy all the macros, button for button, from one station address to another. This is a nice timesaver if you have more than one station controlling a zone, or if you have several stations and zones that are identical and you just wish to go in and edit the macros to reflect the changes in zones. Upon entering this menu you will see the following display:

IMPORTANT NOTE: If you edit a macro and exit without pressing Save first you will lose all of your work! This may be desirable if you have changed your mind concerning the changes that you have made. Or it may not if you want to keep the macro that you have just entered.

```
V2.01      Copy macros from one station to another

          Currently programmed station addresses:

01 - Factory default      09 - Factory default
02 - Factory default      10 - Factory default
03 - Factory default      11 - Factory default
04 - Factory default      12 - Factory default
05 - Factory default      13 - Factory default
06 - Factory default      14 - Factory default
07 - Factory default      15 - Factory default
08 - Factory default      16 - User defined

Enter station address to copy from (source):

          Press [Enter] when finished, [Esc] to quit.
```

After entering the station address to copy from (which in the example below is station 01), we are prompted for the address of the station to copy to:

```
V2.01    Copy macros from one station to another

        Currently programmed station addresses:

01 - Factory default      09 - Factory default
02 - Factory default      10 - Factory default
03 - Factory default      11 - Factory default
04 - Factory default      12 - Factory default
05 - Factory default      13 - Factory default
06 - Factory default      14 - Factory default
07 - Factory default      15 - Factory default
08 - Factory default      16 - User defined

Enter station address to copy from (source): 01
Enter station address to copy to (destination):
        Press [Enter] when finished, [Esc] to quit.
```

Note that if you copy the macros from one factory default station to another, the destination station is considered to have become a user defined station. After entering the destination address, the macros will be copied from the source station address to the destination address and you will be returned back to the Configure Stations and Macros menu.

5) Delete a station and all it's macros?

Well this seems self explanatory, right? Upon entry to this menu item you will be prompted to enter the station address that you want to delete:

```
V2.01    Delete a station and all of it's macros

        Currently programmed station addresses:

01 - Factory default      09 - Factory default
02 - Factory default      10 - Factory default
03 - Factory default      11 - Factory default
04 - Factory default      12 - Factory default
05 - Factory default      13 - Factory default
06 - Factory default      14 - Factory default
07 - Factory default      15 - Factory default
08 - Factory default      16 - User defined

Delete Station:
        Press [Enter] when finished, [Esc] to quit.
```

After entering the station address, you will be given a warning that you are about to delete a station, and asked to confirm that you want to delete the station address shown. The display asking for confirmation is:

```
V2.01      Delete a station and all of it's macros

          Currently programmed station addresses:

01 - Factory default  09 - Factory default
02 - Factory default  10 - Factory default
03 - Factory default  11 - Factory default
04 - Factory default  12 - Factory default
05 - Factory default  13 - Factory default
06 - Factory default  14 - Factory default
07 - Factory default  15 - Factory default
08 - Factory default  16 - User defined

Delete Station: 16
WARNING! This is a permanent change!
Are you sure? [Y] for yes, [Esc] to quit:
```

To confirm the deletion, you must enter an upper case **Y**, or press the **[Esc]** key to exit.

Configuring Zones

```
V2.01

          Configure Zones

1) Split a zone?
2) Set min/max/default/mute volume levels for a zone?
3) Select Last/Default volume for a zone?
4) Set left/right balance for a zone?
5) Set bass/treble levels for a zone?

          Select an item and press [Enter]:
          [Esc] to return to MAIN MENU.
```

This menu is the jumping off point for the menus that allow you to configure how a zone is going to work. This includes whether the zone is a normal stereo zone or a split mono zone, the volume level defaults and limits for each zone, left and right balance and the bass and treble levels for the zones.

1) Split a zone?

This option allows you to split a single stereo zone into two mono zones with common source select and control functions, but with separate volume control functions. This can be used instead of installing autoformers, and lets you keep the look and feel of the system in the rooms that have been deemed secondary to the main system (laundry room, maid's room, coat closet, pantry, dog house, tool shed, bird cage, etc). There is one caveat to using this feature, and that is the resolution and range of the volume controls will be similar to that of an autoformer. The range is only 38db, in 1.25db steps. You do still have the use of the maximum volume feature along with default initial level. Upon selection of this option you are prompted to enter the zone number you wish to split:

```
v2.01

                          Split a zone

1) Zone 1: [Stereo zone]
2) Zone 2: [Stereo zone]
3) Zone 3: [Stereo zone]
4) Zone 4: [Stereo zone]
5) Zone 5: [Stereo zone]
6) Zone 6: [Stereo zone]

Enter zone number and press [Enter]:
[Esc] to return to previous menu.
```

You change the state of a zone by typing the zone number and pressing **[Enter]**, which will toggle the state of the zone. For example, if you enter **[1]** and **[Enter]**, zone 1 which was a stereo zone will now be a split mono zone and the display will look like the one shown below:

```
v2.01

                          Split a zone

1) Zone 1: [Split mono zone]
2) Zone 2: [Stereo zone]
3) Zone 3: [Stereo zone]
4) Zone 4: [Stereo zone]
5) Zone 5: [Stereo zone]
6) Zone 6: [Stereo zone]

Enter zone number and press [Enter]:
[Esc] to return to previous menu.
```

2) Set min/max/default/mute volume levels for a zone?

This menu item allows you to set the minimum and maximum volume levels for each zone, as well as the mute and default volume levels for each zone. What this means is that you can set how loud it will get in a particular zone, which is handy when the amplifier is capable of driving the speakers to 125db volume levels and the cheesy (oops! sorry!) in-wall speakers won't take the joke! The minimum volume setting allows you to compensate for the combination of poor speaker location (blame the interior designer for putting them behind the couch) and the inefficient speakers that were used. You can set up the Director so that the lowest volume level heard in the room will be just below the point at which music is heard, giving the system an additional response "feel" when raising the volume, that it is "there for you" immediately. Previous systems we have encountered have required you to hold the volume up button for an extended time, just to reach the point at which you hear music.

The default volume level is the level that the zone comes on at when a source is selected or the zone is unmuted, if the Last/Default Volume option is set to default for this zone. Default volume levels are independently settable for each zone. The mute volume level is the level the zone goes to when the mute function is engaged. This may be set to any level below the current volume level down to true mute (-95db).

Upon entry to this section the Director will display the current level settings for all six zones. The display for the factory default settings looks like:

```
V2.01
Set Minimum, Maximum, Default and Mute volume levels for a zone

      Zone 1:   Zone 2:   Zone 3:   Zone 4:   Zone 5:   Zone 6:
MIN:  [-63.75db] [-63.75db] [-63.75db] [-63.75db] [-63.75db] [-63.75db]
MAX:  [-12.50db] [-12.50db] [-12.50db] [-12.50db] [-12.50db] [-12.50db]
Default: [-52.50db] [-52.50db] [-52.50db] [-52.50db] [-52.50db] [-52.50db]
Mute:  [-78.75db] [-78.75db] [-78.75db] [-78.75db] [-78.75db] [-78.75db]

      Enter zone number and press [Enter]:
      [Esc] to return to previous menu.
```

At this point you are being prompted to select a zone to edit the levels for. For the following examples we will work with zone 1. After selecting zone 1 we will be at the following display:

```
V2.01
Set Minimum, Maximum, Default and Mute volume levels for a zone

Current level settings for zone 1 are:

      1) MIN:          [-63.75db]
      2) MAX:          [-12.50db]
      3) Default:     [-52.50db]
      4) Mute:         [-78.75db]

      Enter level to set and press [Enter]:
      [Esc] to return to previous menu.
```

Starting with the minimum volume level, we select option 1 and get the minimum volume entry display:

```
V2.01

      Set Minimum volume for a zone

Current minimum volume for zone: 1 is [-63.75db]

Enter new volume level [0 to -78.75db] and press [Enter]:
      [Esc] to return to previous menu.
```

At this point we can enter the new minimum volume level. The Director works in increments of 1.25db, however you don't need to be that absolutely precise with the level entry. The Director will find the nearest 1.25db increment to the value that you enter within the range of 0 (maximum level out) and -78.75db (minimum level out). The '-' sign is optional. After entering the new level you will be returned back to the display of the zone's four levels where you can select another level to set.

Configuration of the maximum volume level is identical to the minimum level. Selecting option 2 will put you at the following display:

```
V2.01

      Set Maximum volume for a zone

Current maximum volume for zone: 1 is [-12.50db]

Enter new volume level [0 to -78.75db] and press [Enter]:
      [Esc] to return to previous menu.
```

At this point we can enter the new maximum volume level that the zone will go to. The same details apply to setting level as was discussed above under the minimum volume level edit display.

Configuration of the default volume level is identical to the minimum and maximum volumes. Selecting option 3 will put you at the following display:

```
v2.01
      Set Default volume for a zone

Current default volume for zone: 1 is [-52.50db]

Enter new volume level [0 to -78.75db] and press [Enter]:
      [Esc] to return to previous menu.
```

The default volume level is the level that the zone will come on at after the initial system power up. If the zone has been configured to use the last volume setting feature then the default volume will only come into play if some event (such as a system wide reset) causes the Director to lose track of the current volume level.

The final item on this list is the ability to set the mute volume level. Now you may be wondering why this is an option. One reason is that you may desire to not have the audio go away entirely in a particular zone when it is muted. So the option is available. Selecting option 4 will get you the following display:

```
v2.01

          Set Mute volume for a zone

Current mute volume for zone: 1 is [-78.75db]

Enter new volume level [0 to -78.75db] and press [Enter]:
          [Esc] to return to previous menu.
```

You will notice that the factory default setting for this option is already as low in level as it can go. Changing the level is done using the same set of rules as noted in setting the minimum volume level.

Once you have set the various levels for a zone, you may return to the display of levels for all the zones and select another zone to edit.

3) Select Last/Default volume for a zone?

The Last/Default volume option configures the behavior of the Director in a particular zone when the system is turned on. The Last option restores the volume level in a zone to whatever it was set at when it was last turned off. Please note that when using the Last option, that whenever the Director's power is removed and reapplied, the Director will use the Default volume in place of a Last volume level, so you will still need to set the default level to some sane value. The Default option allows you to set the volume level that a zone will come on at, regardless of where it was set when the system was turned off (great for a house with teenage children...). When you enter this menu, you will see a list of the settings for each zone:

```
v2.01
      Select Last/Default volume for a zone

1) Zone 1:      [Using default volume]
2) Zone 2:      [Using default volume]
3) Zone 3:      [Using default volume]
4) Zone 4:      [Using default volume]
5) Zone 5:      [Using default volume]
6) Zone 6:      [Using default volume]

      Enter zone number and press [Enter]:
      [Esc] to return to previous menu.
```

When you pick a zone, the zone's configuration changes from what it currently is to the other choice. Which means that by selecting zone 3 by entering **[3] [Enter]**, zone 3 would change from Using default volume to Using last volume setting. When you are done, pressing **[Esc]** will return you to the Configure Zones menu.

4) Set left/right balance for a zone?

Balance between the left and right channels in a zone may be set for each zone. This feature isn't a traditional balance control, in the sense that one channel gets louder as the other channel gets softer. Our balance control allows you to attenuate the level of the channel that appears to be louder, without affecting the volume level of the other channel. Either channel may be attenuated. This means that you should only adjust one of the two channels. The other channel should be left at full. Like the volume level adjustment menu above, the balance is adjusted by entering the amount in 1.25db steps that you need to attenuate the channel that is louder by. Upon entry you will be shown the current balance levels for all of the zones and asked to enter the zone number for the zone that you wish to adjust:

V2.01

Set left/right balance for a zone

	Zone 1:	Zone 2:	Zone 3:	Zone 4:	Zone 5:	Zone 6:
Left	[- . 0db]	[- . 0db]	[- . 0db]	[- . 0db]	[- . 0db]	[- . 0db]
Right	[- . 0db]	[- . 0db]	[- . 0db]	[- . 0db]	[- . 0db]	[- . 0db]

Enter zone number and press [Enter]:

[Esc] to return to previous menu.

After selecting a zone to edit, you will see a summary of the settings for the zone, and be asked to pick a level to set, in a manner similar to setting the min, max, default and mute volume levels. The display is as follows:

```
V2.01
      Set Left and Right balance levels for a zone

Current level settings for zone 1 are:

1) Left   [- . 0db]
2) Right  [- . 0db]

Enter level to set and press [Enter]:
      [Esc] to return to previous menu.
```

Choosing the left channel, you will be prompted to enter the new level for the channel. The display looks like this:

```
V2.01
      Set Left balance level for a zone

Current Left balance level for zone 1 is: [- . 0db]

Enter new left balance level [-37.5db to 0db] and press
[Enter]:

      [Esc] to return to previous menu.
```

As in the volume level setting menus the balance level is settable in 1.25db increments of attenuation. Which means that 0db represents full output, and -37.5db represents maximum attenuation. If you choose to edit the balance level for the right channel, the display will look like this:

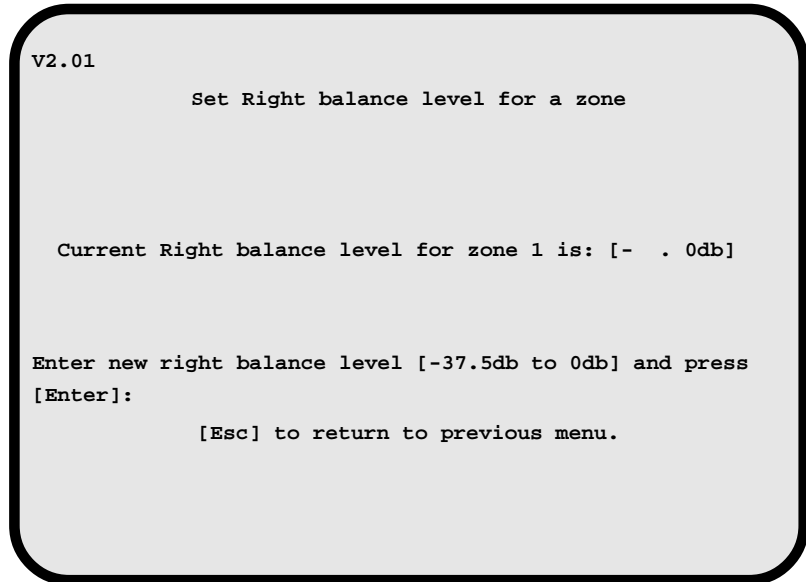

After entering either the left or right channel balance level, you will return to the display allowing you to see what the new levels are for the zone you are adjusting. The [Esc] key will get you back to the display showing the levels for all six zones, and from there back to the Configure Zones menu.

5) Set treble/bass levels for a zone?

We hope you won't bother using the built in treble and bass adjustments and will instead opt to use our companion AudioControl product, the Architect 1250 combination 6 stereo zone amplifier and 6 band per zone equalizer, which will give much better results. However, we realize that not everyone will be using the Architect 1250, so we've provided a limited tone control set in the Director. The adjustment of this option works in the same fashion as the volume and balance menus, in that you edit the level using the menus that we have provided.

So, you enter this menu item and you are presented with the display of the bass and treble levels for all six zones as well as being asked to select the zone to change the levels of. The display looks like this:

```
v2.01
Set bass/treble levels for a zone

      Zone 1:  Zone 2:  Zone 3:  Zone 4:  Zone 5:  Zone 6:
Treble: [ 0db] [ 0db] [ 0db] [ 0db] [ 0db] [ 0db]
Bass:   [ 0db] [ 0db] [ 0db] [ 0db] [ 0db] [ 0db]

Enter zone number and press [Enter]:
      [Esc] to return to previous menu.
```

Selecting a zone to edit will bring you to the screen where you can choose to edit the treble or the bass level for that zone. The display looks like:

```
v2.01
Set Treble and Bass levels for a zone

Current level settings for zone 1 are:

1) Treble: [ 0db]
2) Bass:   [ 0db]

Enter level to set and press [Enter]:
      [Esc] to return to previous menu.
```

At the risk of repeating ourselves, you need to choose to edit either the treble or the bass level. Selecting the treble first, we are presented with the following screen:

```
v2.01

          Set treble level for a zone

Current Treble level for zone 1 is: [ 0db]

Enter new treble level [-14db to +14db in 2db steps] and press [Enter]:
          [Esc] to return to previous menu.
```

As shown in the above screen display, the maximum levels are ± 14 db, and they are setable in 2db increments. If you had chosen to edit the bass level for the zone, you would be presented with the following display:

```
          Set bass level for a zone

Current Bass level for zone 1 is: [ 0db]

Enter new bass level [-14db to +14db in 2db steps] and press [Enter]:

          [Esc] to return to previous menu.
```

And that completes all of the options that are available for configuring the zones.

Configuring Sources

V2.01

Configure Sources

- 1) Select source manufacturer and type?
- 2) Edit machine control function assignments for a source?
- 3) Set input gain level?
- 4) Set machine control via IR or direct in?
- 5) Set machine control delays?
- 6) Set command sent when source deselected?
- 7) Set command sent at source power up?
- 8) Download new IR code?

Select an item and press [Enter]:

[Esc] to return to MAIN MENU.

Source configuration consists of selecting the type of source, its manufacturer or IR control type, and the source number that it is connected to on the Director. Once the Director has been told of the source type, you then need to make the necessary machine control command assignments that are relevant for that source to be controlled by the macros that you have configured for the stations. Please note that changing the manufacturer for a given source type will not change the machine command assignments. So if you are using the factory default and wish to use a Yamaha CD player instead of a Sony, the machine command assignments (play, stop, etc) will be left as previously set. However there is one caveat - if you change from one manufacturer to another, be aware that the new manufacturer may not support all of the same features and or machine commands as the previous manufacturer. Expect to have to adjust the machine commands and macros accordingly if you are using any of the unique features on the source.

1) Select source manufacturer and model?

When you enter this menu item, you will be prompted to select which source number this will be:

```
v2.01

      Select source manufacturer and type

Current manufacture and source type is:

1) Source 1: RC 5 Tuner
2) Source 2: RC 5 Tuner
3) Source 3: Sony CD Player
4) Source 4: Sony CD Player

      Enter source number [1-4]
      [Esc] to return to previous menu.
```

The Director comes preset with a factory default selection of sources. You can replace any or all of the sources with different sources from the Director's internal library of source control commands. The above display shows the sources that were preset at the factory. If you want to change a source, you need to tell the Director which source to edit by entering the number of the desired source and pressing the **[Enter]** key. The Director will present you with a list of sources, indexed by manufacturer or by IR control type as in the case of RC5 compatible sources:

```
v2.01

      Select source manufacturer and type

Current manufacture and source type for source 1 is:
                        RC 5 Tuner

1) Sony
2) RC 5
3) McIntosh
4) Parasound type 1
5) Yamaha
6) Parasound type 2
7) User defined (uploaded)

      Select which manufacturer from the list:
      Press [Enter] when finished, [Esc] to quit.
```

Selection is made by entering the number next to the desired manufacturer. Once this is done, you need to select what type of source it is, such as CD player, Tuner, etc., and if applicable, what model the source is. Some manufacturers use the same control codes for all machines of a given type. A good example is Sony which has kept the same IR machine control codes for all of their CD players from the lowest \$149 unit, to the high end \$2000 unit. Not all of the manufacturers are as consistent, unfortunately. Note: if the source that you are using doesn't appear on the list, you can choose the custom option, which will require that you upload the IR codes for the source to the Director. Please contact the AudioControl factory for a list of currently available IR codes. It may also be possible that the source you are using will respond to control codes by another manufacturer. A number of the major manufacturers use the same chip sets for IR control, and have assigned the same control codes to the same functions. You may wish to try several of the major manufactures to see if this is possible. So you are now prompted with:

```
v2.01
      Select source manufacturer and type

      Current manufacture and source type for source 1 is:
              RC 5 Tuner

1) CD Player
2) Tape type 1
3) Tape type 2
4) Tuner

      Select source type from the list:
      Press [Enter] when finished, [Esc] to quit.
```

Once again, you will be presented with a list of types of sources to choose from. Simply enter the number next to your choice and you are done.

2) Edit machine control function assignments for a source?

The Director assigns a default set of machine control functions to a given source. Since the Director is designed to support a maximum of 16 machine control functions for a given source, and the source may have many more than 16 possible options, this editor is provided to allow you to choose which specific machine control functions are desired in your particular installation.

Upon entry you need to tell the Director which source you are going to edit:

```
V2.01
Edit machine control function assignments for a source

Current manufacture and source type is:

1) Source 1: RC 5 Tuner
2) Source 2: RC 5 Tuner
3) Source 3: Sony CD Player
4) Source 4: Sony CD Player

Enter source number [1-4]
[Esc] to return to previous menu.
```

After selecting the source to edit, you will be presented with a list the 16 machine control commands and which actual machine control functions have been assigned to them. The list will look like:

```
V2.01 Edit machine control function assignments for a
source
Machine control assignments for source 1 :
RC 5 Tuner

1) Preset UP
2) Preset DWN
3) 1
4) 2
5) 0
6) unassigned
7) unassigned
8) unassigned
9) unassigned
10) unassigned
11) unassigned
12) unassigned
13) unassigned
14) unassigned
15) unassigned
16) unassigned

Enter command number [1-16] to change:
Press [Enter] when finished, [Esc] to quit.
```

The list of commands that were assigned to the machine control functions by the Director for source 1 will be listed. Note that commands 6 through 16 have no machine control function listed. This means that no machine control function had been assigned to it. To change a machine control command, select the number of that command, and press **[Enter]**. You will then be presented with a list of available machine control functions for that machine, and the opportunity to select a new command.

```
V2.01  Edit machine control function assignments for a source
        Source 1 , machine command: 1
        RC 5 Tuner

4) Preset UP
5) Preset DWN
11) Search UP
12) Search DWN
15) Scan FWD
16) 0
17) 1
18) 2
19) 3
20) 4
21) 5
22) 6
23) 7
24) 8
25) 9
51) Clear
Enter command number for new machine control, 0 to disable
N for next page of commands, P for previous:
        Press [Enter] when finished, [Esc] to quit.
```

As you can see from the above screen, there is a list of possible commands. The above list has additional commands not visible, which you can see by pressing the **[N]** key to page forward and the **[P]** key to page backward through the list. When you find the command that you want, you need to enter the number that corresponds to the command and press the **[Enter]** key. After changing a machine control command's function assignment, the list of commands for this source will be redisplayed, allowing you to change other machine control functions.

3) Set input gain level?

The Director allows you to adjust the input gain for each source over an 18db range, in increments of 6db. This is useful in matching the levels between each source, in a rough manner. Typically, tuners have a lower output than CD players, with tape decks falling somewhere in between. Upon entry to this menu item, you will see a display of the input gain settings for each of the 4 sources:

```
v2.01

                Set input gain level

1) Source 1 gain is: [0 dB]
2) Source 2 gain is: [0 dB]
3) Source 3 gain is: [0 dB]
4) Source 4 gain is: [0 dB]

Enter source number [1-4]

                [Esc] to return to previous menu.
```

Enter the number of the source that you wish to change. The Director's factory default settings for all four sources is for the gain to be 0. Warning: While the Director has a great deal of headroom with regard to the nominal input levels expected from line level source equipment, it is possible to overload and clip the input stage of the Director if too great of a gain setting is used with a high output level source. Use of this feature should be limited to increasing the level of lower output level sources to match the highest output level source in the system.

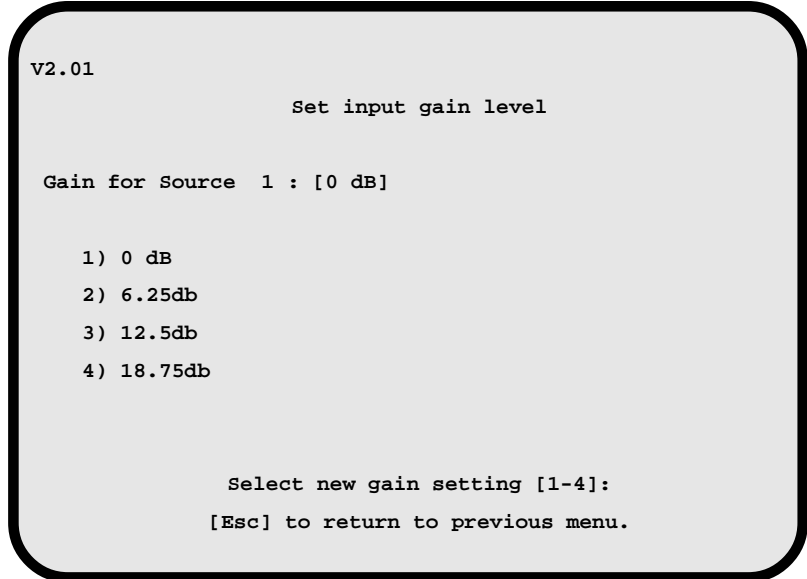

The Director presents you with 4 possible settings for the new input gain, ranging from 0 to 18.75db of gain in 6.25db increments. After selecting a new gain setting and pressing the **[Enter]** key, you will be returned to the previous menu.

4) Set machine control via IR or direct in?

The Director Model 46 is capable of controlling source equipment either by using IR emitters to send the commands just as a hand held remote control would, or with the appropriate interface unit, by means of passing the commands to a control port that the equipment manufacturer has provided on the back of the source unit. In most cases when using the direct input, the source equipment expects the control pulses without the high frequency carrier signal used to modulate the IR led in the remote control. So we have provided a menu to allow you to turn on and off the high frequency IR carrier for each source.

Upon entering this menu you will see the following display:

```
v2.01

Set machine control via IR or direct in

1) Source 1 IR carrier is: [enabled]
2) Source 2 IR carrier is: [enabled]
3) Source 3 IR carrier is: [enabled]
4) Source 4 IR carrier is: [enabled]

Enter source number [1-4]
[Esc] to return to previous menu.
```

The default configuration is to have all of the IR carriers turned on. When you select a source by entering the number of the source and pressing the **[Enter]** key, it will cause the current state of the carrier to change to the other state. IE: If the carrier is currently enabled (on), it will be disabled (turned off). The display will be updated, to reflect the new status, as shown below.

```
v2.01

Set machine control via IR or direct in

1) Source 1 IR carrier is: [disabled]
2) Source 2 IR carrier is: [enabled]
3) Source 3 IR carrier is: [enabled]
4) Source 4 IR carrier is: [enabled]

Enter source number [1-4]
[Esc] to return to previous menu.
```

5) Set machine control delays?

One of the features of the Director is the ability to wait for the source, such as a CD player, to go through it's various internal contortions on the way to making music. Each source will have it's own idiosyncratic behavior, and it is not always possible to plan in advance how the source will behave. Each machine control function for each source has a delay time associated with it. The delays are used to return status feedback to the control stations in the form of blinking button leds to indicate that the system is doing something while the homeowner waits for the music to start playing. The other need for machine control delays comes into play when using the Director with an external home automation system. In this case, the Director can't or shouldn't return a status message to the external control system until such time as the source has finished it's gyrations and plays music. When you enter this menu item, you will be prompted for the source number:

```
v2.01
```

```
Set machine control delays
```

- 1) Source 1 not configured
- 2) Source 2 not configured
- 3) Source 3 not configured
- 4) Source 4 not configured

```
Enter source number [1-4]
```

```
[Esc] to return to previous menu.
```

After entering the source number, you will be presented with the list of the 16 machine control functions that have been assigned to the source, and the delay times that have been associated with them:

```
V2.01          Set machine control delays
                Machine delay times for source 3:

                Sony CD Player
1) Play        delay not configured
2) Pause       delay not configured
3) Next Track  delay not configured
4) Next Disc   delay not configured
5) Prev Track  delay not configured
6) Shuffle     delay not configured
7) Stop        delay not configured
8) Disc 1     delay not configured
9) Disc 2     delay not configured
10) Disc 3    delay not configured
11) Disc 4    delay not configured
12) Disc 5    delay not configured
13) Continue  delay not configured
14) Program    delay not configured
15) unassigned delay not configured
16) unassigned delay not configured

Enter command number [1-16] to edit it's delay time:
Press [Enter] when finished, [Esc] to quit.
```

Entering the command's number will get you a prompt to enter the delay time for that command:

```
V2.01          Set machine control delays
                Machine delay times for source 3:

                Sony CD Player
1) Play        delay not configured
2) Pause       delay not configured
3) Next Track  delay not configured
4) Next Disc   delay not configured
5) Prev Track  delay not configured
6) Shuffle     delay not configured
7) Stop        delay not configured
8) Disc 1     delay not configured
9) Disc 2     delay not configured
10) Disc 3    delay not configured
11) Disc 4    delay not configured
12) Disc 5    delay not configured
13) Continue  delay not configured
14) Program    delay not configured
15) unassigned delay not configured
16) unassigned delay not configured

Enter delay time (0 to 30 seconds) for command 1 :
Press [Enter] when finished, [Esc] to quit.
```

You may any delay time from 0 (which will disable the timer) to 30 seconds. The Director will then redisplay the status of the machine delay times for each of the commands for the source, updated with the new delay time that you set for that command, as shown below.

```
V2.01          Set machine control delays
                Machine delay times for source 3:

                Sony CD Player
1) Play        delay 3 seconds
2) Pause       delay not configured
3) Next Track  delay not configured
4) Next Disc   delay not configured
5) Prev Track  delay not configured
6) Shuffle     delay not configured
7) Stop        delay not configured
8) Disc 1     delay not configured
9) Disc 2     delay not configured
10) Disc 3    delay not configured
11) Disc 4    delay not configured
12) Disc 5    delay not configured
13) Continue  delay not configured
14) Program   delay not configured
15) unassigned delay not configured
16) unassigned delay not configured

Enter command number [1-16] to edit it's delay time:
Press [Enter] when finished, [Esc] to quit.
```

When you are finished setting the delay times for this source, you can press **[Esc]** to return to the previous menu and select another source to set delay times for.

6) Set command sent when source deselected?

The director Model 46 is able to determine when a source is no longer being listened to, and can be configured to send a machine command to a source after a setable delay time has expired. This means that you can configure the Director to send a Stop command to a CD player after the home owner has decided to spend the rest of the day listening to the tuner. The Director considers a source to be “deselected” or otherwise not in use when it was previously selected but is no longer selected in any zone that is unmuted. It also considers the source to be deselected when the zone that was previously playing music has been muted. So if zone 1 was listening to the CD player and is now listening to the tuner, zone 3 was listening to the CD player and is now muted, and the remaining zones are not listening to the CD player, the CD player is considered to be deselected. The Director will start the deselect command timer for the CD player. Upon expiration of the timer, the Director will send the appropriate machine command, which in this case would be Stop. To select the machine command sent on deselect you will be presented with the following menu:

```
v2.01

      Set command sent when source deselected

1) Source 1 not configured
2) Source 2 not configured
3) Source 3 machine command: 7
4) Source 4 machine command: 7

      Enter source number [1-4]
      [Esc] to return to previous menu.
```

As you can see in the above menu, sources 3 and 4 have machine commands assigned to the deselect function. After choosing a source you will be presented with the list of commands available for the source. These are the 16 machine commands that you have configured for the source. The menu to select the machine command from looks like:

```
V2.01          Set command sent when source deselected
                Machine control assignments for source 3 :

Sony CD Player
  1) Play
  2) Pause
  3) Next Track
  4) Next Disc
  5) Prev Track
  6) Shuffle
  7) Stop
  8) Disc 1
  9) Disc 2
 10) Disc 3
 11) Disc 4
 12) Disc 5
 13) Continue
 14) Program
 15) unassigned
 16) unassigned

Enter command number [1-16] for new deselect command, N for none:
Press [Enter] when finished, [Esc] to quit.
```

Enter the number of the machine command that you want the Director to send to the source when the deselect timer expires and press the **[Enter]** key. If you do not want any command to be sent to the source, or wish to disable a previously configured command, you can enter an **[N]** for no command. You will be returned to the previous menu, which will allow you to set the deselect command for another source.

7) Set command sent at source power up?

This sub menu is provided to allow you to configure the Director to send a machine command to each of the sources right after the power has been applied. A number of sources, notably CD players, seem to have a 'mind of their own' and will start playing as soon as power has been applied if they detect that there is a CD in the drawer. With this sub menu, you can send a command to each of the sources, putting the sources in a known state. After all, there's no reason the CD player should be playing a disc that was left in it, if all the home owner wants to do is listen to the tuner, right?

Another use for this feature is to tell a source to power up. Some sources do not have real power switches, but relegate the power on/off function to a button on the remote control (and a momentary contact button on the front of the source). While we would like to discourage you from using these types of source equipment, we realize that you may not

have a choice in the decision. Especially if this is a piece of source gear that your client “must have”. The Director gives you the ability to handle these types of problems.

Upon entry to this sub menu, you will see the status of the commands assigned to the four sources, and which machine command has been assigned to each source, if one was assigned.

v2.01

Set command sent at source power up

Current power on command is:

- 1) Source 1: not configured
- 2) Source 2: not configured
- 3) Source 3: not configured
- 4) Source 4: not configured

Enter source number [1-4]

[Esc] to return to previous menu.

After selecting the source, you will be presented with a list of possible commands. Note that this is the same list that you saw when you were assigning the functions to the 16 machine commands, and it represents the available machine commands that are in the IR control library. Since it is possible that you will be using a command for this function that is not needed in any macro, we decided to not require that it be a function that was assigned to one of the 16 machine commands that are used in macros. The display to select the command looks like:

```
V2.01          Set command sent at source power up
                Select power on command for source 3 :

                                Sony CD Player

1) Stop
2) Play
3) Pause
4) Next Track
5) Prev Track
6) Next Disc
7) Prev Disc
8) Shuffle
9) Continue
10) Music Scan
11) Search FWD
12) Search REV
17) 1
18) 2
19) 3
20) 4

Enter command number for new power on command, 0 to disable
N for next page of commands, P for previous:
Press [Enter] when finished, [Esc] to quit.
```

One final note about this feature. The machine command is sent after the power on delay for the sources has expired. So if you are planning on using this feature to ‘press the power button’ on a source, the Director won’t be sending the command until the end of the source power on delay. This will mean that the source’s power on command is sent right before the power to the amplifiers is applied. While this shouldn’t be a problem, we did want to let you know what the behavior of the feature will be.

8) Download new IR code?

This function allows you to download into the Director new IR control codes supplied by AudioControl. Try as we might, there is no way to keep every single IR control code for every single type of source equipment in the Director's internal IR library. So we gave you (and us) a way out. Please contact your AudioControl representative or the AudioControl factory for more information on the availability of IR codes for your sources. Upon entering this menu you will be prompted with the following screen asking you to select a source:

```
v2.01
Download new IR code

Current manufacture and source type is:

1) Source 1: RC 5 Tuner
2) Source 2: RC 5 Tuner
3) Source 3: Sony CD Player
4) Source 4: User defined (uploaded)

Enter source number [1-4] to upload new IR data:
[Esc] to return to previous menu.
```

After you enter the source number, the Director will prompt you to start the upload. The screen looks like this:

```
Begin ZMODEM file upload now. Type CTRL-X 5 times to exit.
```

☞ IMPORTANT

NOTE: While the Director will allow you to upload commands for any of the sources, the uploaded commands will only be available when the source type has been set to User defined.

At this point you need to start the file transfer with your terminal emulation software. Please note that your terminal emulation software must support the Zmodem file transfer protocol to be used with this feature. If you enter this point by mistake you can type five successive [CTRL] [X] commands or you can wait, and the Director will time out in one minute and return you to the Configure Sources sub menu. Upon completion of the upload of the IR commands, the Director will return to the Configure Sources sub menu.

Configuration Utilities

System related configuration utilities are located in this sub menu. This includes saving all of the configuration information to an external computer, copying configuration information that was saved on an external computer back into a Director, clearing the configuration and restoring the factory default configuration.

v2.01

Configuration Utilities

- 1) Download configuration to external computer via serial port?
- 2) Upload configuration from external computer via serial port?
- 3) Clear all configuration information?
- 4) Restore factory configuration?

Select an item and press [Enter]:

[Esc] to return to MAIN MENU.

1) Download configuration to external computer via serial port?

This option allows you to save all of the configuration information that you have entered into the Director to a disk file on an external PC. When you choose this option, the Director will prompt you for the file name to save the information to:

```
v2.01
Download configuration to external computer via serial port

Enter the file name to save all configuration information to:

Press [Enter] when finished, [Esc] to quit.
```

After you have entered the file name to save to, the Director, using the Zmodem file transfer protocol, will initiate a file transfer to your computer. Your terminal emulation software must be able to support the Zmodem protocol, must be preconfigured to use this protocol as the default, have the auto transfer feature enabled, and must have the proper subdirectory set up to receive the file. When the Director has completed the transfer, it will return to the Configuration Utilities sub menu.

2) Upload configuration from external computer via serial port?

This option allows you to copy a previously stored configuration file to the Director. This is useful if you need to duplicate the setup of an installation for use in another installation, you've accidentally deleted the configuration, or in the unlikely event that a Director suffers from amnesia (or an unintentional lobotomy using option 3 of this menu), you can restore it's identity. When you enter this menu item, the Director will prompt you to begin the file download:

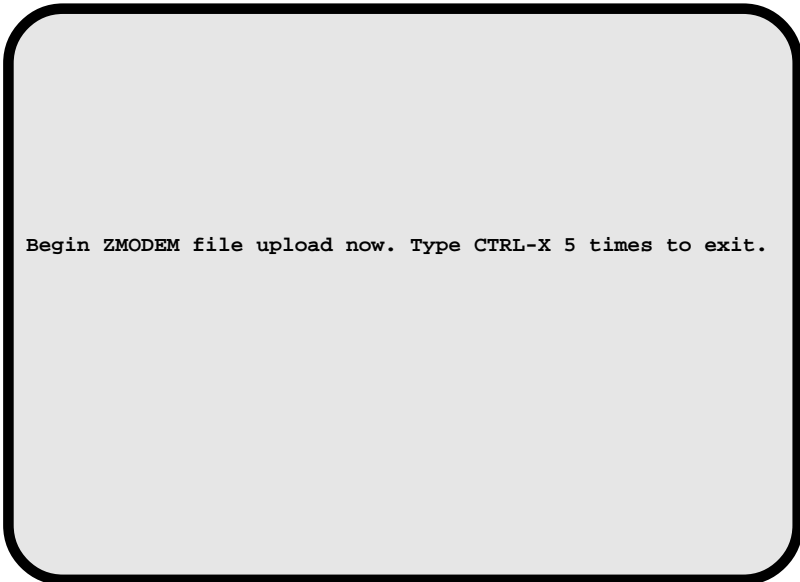

```
Begin ZMODEM file upload now. Type CTRL-X 5 times to exit.
```

At this point, the Director is waiting for the file transfer to begin. You must use the file transfer function in your terminal emulator package, with the Zmodem protocol to download the file to the Director. You can cancel the file transfer by typing five [CTRL] [X] commands to the Director, or by waiting for the Director to time out when it detects that no file transfer has occurred in one minute. When the file transfer is complete, the Director will return to the Configuration Utilities sub menu.

3) Clear all configuration information? [USE WITH CARE!]

This option is used to clear out all the configuration information in a Director, including the factory defaults, if the Director has been set up that way. Once the Director has cleared all configuration information, there is no way to recover any information that was cleared. The Director must either be reconfigured, downloaded from a PC, or have the factory defaults restored from internal ROM. Use this option with care! It is real easy to completely blow a whole day or more of work with this option! When you enter this option you will need to confirm that you wish to clear all of the configuration information:

```
v2.01

      Clear all configuration information

THIS WILL ERASE ALL EXISTING MACROS AND CONFIGURATION
INFORMATION THAT YOU HAVE PROGRAMMED INTO THIS DIRECTOR!
Clear all programming? Everything? Sources, Stations, Macros?

      WARNING! This is a permanent change!

Are you sure? [Y] for yes, [Esc] to quit:
```

You must enter an upper case **[Y]** for yes, followed by the **[Enter]** key. Entry of any other key except **[Esc]** will simply cause the Director to beep your computer at you. Entering the **[Esc]** key will back you out of the clear function without having caused any harm to your configuration information.

This will take a few seconds for the Director to complete the job. When it has finished it will return to the Configuration Utilities sub menu.

4) Restore factory configuration?

This option allows you to restore the factory default configuration which has been stored in internal ROM. Note: Using this feature will clear any previous configuration that you may have entered. If you wish to keep the configuration that you've entered please see the section above

1) Upload configuration to external computer via serial port? for instructions on how to save your configuration information to an external PC.

Upon entering this menu item you will be given a chance to confirm that you wish to restore the factory defaults:

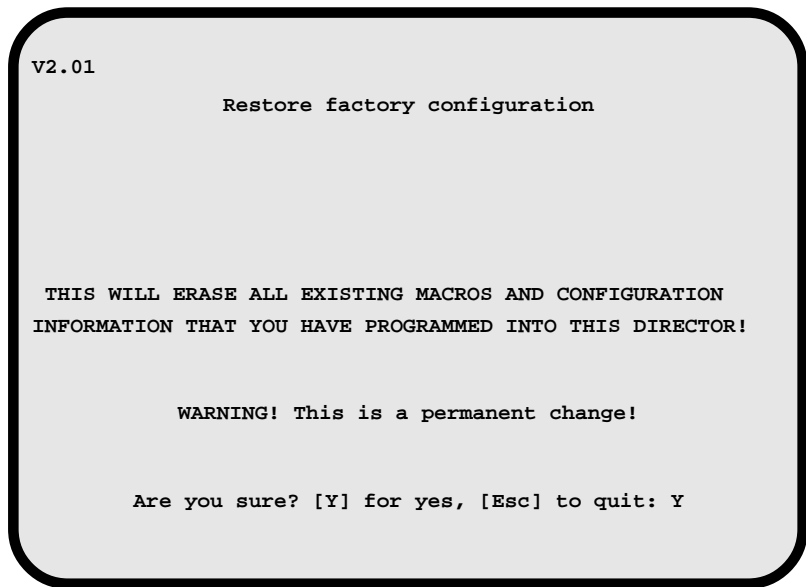

You must enter an upper case [Y] for yes, followed by the [Enter] key. Entry of any other key except for [Esc] will cause the Director to beep your computer at you. Pressing the [Esc] key will make the Director exit gracefully from this option and return you to the Configuration Utilities sub menu.

This is the first phase of the restore. The Director will first clear all existing data from its configuration memory. This step will take a few seconds, and will be followed in turn by each of the items shown in the screen shot below. When the Director has completed restoring all of the factory default configuration information it will return you to the Configuration Utilities sub menu.

```
V2.01

                Restore factory configuration

THIS WILL ERASE ALL EXISTING MACROS AND CONFIGURATION
INFORMATION THAT YOU HAVE PROGRAMMED INTO THIS DIRECTOR!

                WARNING! This is a permanent change!

Are you sure? [Y] for yes, [Esc] to quit: Y

Clearing existing configuration. Please wait.... DONE!
Reloading System Options.... DONE!
Configuring Sources.... DONE!
Configuring Stations and loading macros....
```

This may be one of the most important sub menus in the whole Director configuration system. All of the options located here are dedicated to helping you get a Director system up and running as quickly as possible. If there is a test feature that you think should be in the system, but was not included here, please let us know.

```
V2.01

                System Diagnostics

1) Test station network and report all stations found?
2) Interactive station identification?
3) Test audio path of a zone?
4) Machine control test?
5) Paging subsystem test?
6) Turn on/off source power?[off]
7) Turn on/off amp power?  [off]

                Select an item and press [Enter]:

                [Esc] to return to MAIN MENU.
```

1) Test station network and report all stations found?

 **IMPORTANT**

NOTE: No button pressing on the stations while the test is in progress! This will give false results!

This test will exercise the station network, verifying that the Director and the stations can communicate with each other. When you enter this menu item you will get the following status message:

This test actually consists of a sequence of smaller sub-tests. These sub-tests are run as follows:

a) First we check for power on the station network. If the station network power is not present (due to a short circuit), the test stops and displays an error message. No power, no communications!

b) Once the power is verified, the next test is to see if the data line is also good. This is a simple test that looks to see if the data line is shorted. Once we've determined that the line is not shorted, then we check to see if the cable capacitance is too high to allow reliable communications on the station network. If there is a questionable cabling situation from a data delivery standpoint, we notify you and stop the test. If the network passes this test then we are ready to move on and try to communicate with the stations.

c) If the data line checks out OK, then the next step is to turn off all of the leds on all of the stations. This is done by sequencing through the 256 possible station addresses, sending each station address a message with all of the leds for that station turned off.

d) After all the stations have been sent the led off message, each station address is polled with a message that requires a response. In the response is the status of the leds on the station. When we get a response from a sta-

 **Important Note:** If more than 16 station addresses are detected at this point, the test stops and will display an error message indicating that the Director only supports 16 stations! You must correct this problem before continuing. There are two reasons for this. The first is that the Director software only has storage space for 16 station addresses. The second, slightly more important reason is that the station network power supply in the Director will only support 16 stations with all of their leds on, which is the next part of the test.

tion, we check to see if the station address is one that the Director has been configured for. If the station responding is not in the Director's configuration list, we mark it down as being unassigned. We also check the station's response to make sure that it really received the led off message and responded to it. If the station didn't correctly receive and respond to the led off message, we note that it had communications troubles.

e) Once all of the station addresses have been checked for the presence of stations with leds off, we start sending out messages to all the station addresses, telling the stations to turn all the leds on.

f) After all the stations have been told to turn the leds on, we again scan all the possible station addresses to make sure that the stations correctly received the message. We also note which stations have been entered into the Director configuration, and note any that are not configured. If there are any stations that did not correctly receive the led on messages or that previously responded to a poll message and didn't respond to this poll, we note them as having communications difficulties.

g) We next go back and turn off all the leds on all the stations. This is the final cleanup phase of the test.

h) And then the stations are polled to make sure that all of the stations received the led off message. Again we check for stations that previously responded to a poll message but didn't respond this time, as well as noting if any stations respond that aren't in the current Director configuration.

The final screen that you see before the results of the test are reported looks like this:

```
v2.01
```

```
Test station network and report all stations found
```

```
Network power present - this is a good thing!
```

```
Network data line OK
```

```
Current station is: 19
```

```
Turning LEDS off on all stations.
```

```
Verifying all stations received off command.
```

```
Turning LEDS on on all stations.
```

```
Verifying all stations received on command.
```

```
Turning LEDS off - cleaning up.
```

```
Verifying cleanup.
```

Once the test is finished exercising the station network and testing for the presence of the stations it displays the results of the test. The report screen looks like this:

```
V2.01

      Test results for programmed stations

01-present passed  02-present passed  03-present passed
04-present passed  05-present passed  06-present passed
07-present passed  08-present passed  09-present ERRORS
10-present ERRORS  11-Not found      12-Not found
13-Not found       14-Not found       15-Not found
16-Not found

      Test results for unassigned stations

      Station network test completed.
      [Esc] to return to previous menu.
```

In the above display we can see the station addresses that the Director is configured for, and the status of each station at that address. Note that stations 1 through 10 were found on the network, and that stations 1 through 8 were found to have no communications problems. Stations 9 and 10 had some communications difficulties, and so are noted as having errors. Stations 11 through 16 weren't found, either because they are not in the system or if they were in the system it is because there was no communications established with them. Underneath the section of configured stations is an area where any unconfigured station addresses that were found on the network would be displayed. The same indication of passed or errors would be shown for these unassigned stations.

2) Interactive station identification?

This is a real simple test, the purpose of which is to allow you to verify the settings on the station address switches. There are several different situations where you may wish to do this. One is if you suspect that the address switches or the buttons on a station are having some kind of problem. A second situation is if you are setting up the station addresses off site for someone else to install, and you want to double check the settings on the switches, either at the bench or on site before installing them. There is also the case of when you're not sure what the address was of the station that you just screwed into the wall. So, upon entry to this test you will see:

V2.01

Interactive station identification

Station address is: button pressed is:

Go to the station to identify and press a button.

[Esc] to return to previous menu.

Once you are in this test, you simply go to a station and press a button on the station. The display will put the address that the station is set for and the button number that was pressed on the screen for your viewing pleasure. This is a lot better than hassling with getting the station back out of the wall (since the one that you are questioning is usually the one that gave you the most trouble getting it installed to begin with!).

3) Test audio path of a zone?

The zone test was designed to allow you to exercise all of the adjustable zone options from your PC, without having to worry about the station network being operational. This is an exercising of the electronics that control the audio chain for a zone, and does not involve any of the machine controls, the station network, stations or macros. When you enter this item, you will see the following list of options:

V2.01

Test audio path of a zone

- | | | |
|----------------------------|---------------------------------------|--------|
| 1) Select zone | [1 to 6]? | [none] |
| 2) Select source | [1 to 4]? | [none] |
| 3) Set source gain | [0, 6.25db, 12.5db or 18.75db]?[none] | |
| 4) Set volume level | [0 to -78.75db]? | [none] |
| 5) Set bass tone control | [+14db to -14db, 2db steps]? | [none] |
| 6) Set treble tone control | [+14db to -14db, 2db steps]? | [none] |
| 7) Set Left output level | [0 to -37.5db, M for mute]? | [none] |
| 8) Set Right output level | [0 to -37.5db, M for mute]? | [none] |
| 9) Select page input? | | [none] |
| 10) Test power off mute? | | [none] |

Select test and press [Enter]:

Press [Enter] when finished, [Esc] to quit.

In essence what the above menu gives you is direct access to the hardware that controls the audio paths of the zones. You need to fill in each item in the menu with the relevant data in order to enable the zone to pass audio. The Director will not update the zone audio hardware until all the values are filled in! When you choose a menu item, the valid options or range of values is displayed on the bottom of the screen. Here is a quick description of each menu item:

1) Select zone [1 to 6]?

This item expects a numeric zone selection, numbered 1 through 6, corresponding to zones numbers 1 to 6, respectively.

2) Select source [1 to 4]?

This item expects a numeric source selection, numbered 1 through 4, corresponding to sources numbers 1 to 4, respectively.

3) Set source gain [0, 6.25db, 12.5db or 18.75db] ?

This item expects a numeric selection of the input gain for the source. The valid input range is 1 to 4, corresponding to 0db (1) through 18.75db (4).

4) Set volume level [0 to -78.75db]?

This item expects a numeric value for the volume level. Note that 0 represents full volume (no attenuation), and -78.75 represents the lowest volume possible (maximum attenuation). As the Director deals with volume control in 1.25db steps, it will round your input to the nearest 1.25db step. It is suggested that you start out conservatively with the volume setting (start down near the -78.75db end of the scale), to avoid excessively loud levels, with possible speaker damage.

5) Set bass tone control [+14db to -14db, 2db steps]?

6) Set treble tone control [+14db to -14db, 2db steps]?

These options set the tone control levels. They expect a numeric input in the range of +14 to -14. A value of 0 puts the tone controls in bypass mode.

7) Set Left output level [0 to -37.5db, M for mute]?

8) Set Right output level [0 to -37.5db, M for mute]?

These menu items set the output balance levels for a zone. As with the volume levels, 0db represents maximum output, and -37.5db represents minimum volume level before mute. When a zone is used in split mono mode, these two level settings control the levels for each of the

mono halves of a zone, with the volume setting determining the maximum volume level that the mono zones will go to.

9) Select page input?

This menu item allows you to select between normal zone operation and the paging audio input. The options are 'N' for normal input and 'P' to select the paging input.

10) Test power off mute?

This option, while not really relevant to your actual testing, allows you to verify the correct operation of the Director's power off mute circuitry. The options for this menu item are 'N' for normal, unmuted operation, and 'M' to activate the mute circuitry.

That concludes the audio path tests. While it looks complicated, it really is easy provided you spend a little time working with it along with at least one source and an amplifier with speakers connected.

4) Machine control test?

The machine control test was designed to allow you to exercise the machine control command assignments for a source. It also allows you to troubleshoot the IR or direct input control arrangement that you've chosen to get the commands from the Director to the source unit. When you enter this menu item you will be presented with a list of the four current sources that the Director is configured for:

V2.01

Machine control test

Source 1: RC 5 Tuner

Source 2: RC 5 Tuner

Source 3: Sony CD Player

Source 4: Sony CD Player

Enter source number [1-4] to test:

Press [Enter] when finished, [Esc] to quit.

After you have selected the source to test, you will be presented with a list of the current machine commands that have been assigned to this source. The menu looks like this:

```
V2.01                               Machine control test
                                   Machine control assignments for source 3 :

                                   Sony CD Player

1) Play
2) Pause
3) Next Track
4) Next Disc
5) Prev Track
6) Shuffle
7) Stop
8) Disc 1
9) Disc 2
10) Disc 3
11) Disc 4
12) Disc 5
13) Continue
14) Program
15) unassigned
16) unassigned

                                   Enter number of machine command to test:
                                   Press [Enter] when finished, [Esc] to quit.
```

To test a machine command, simply enter the number of the command (1 to 16), press **[Enter]**

and the Director will proceed to send the command out the respective machine control jack on the rear of the Director.

5) Paging subsystem test?

This test allows you to check both the paging control input and to test the settings of the paging duration timer. When you select this menu item you will see the following display:

v2.01

Paging subsystem test

Status of external page control input is: not present

Status of page audio path is: normal

Enter [P] to enable paging audio, [N] for normal audio (muted) or

[Esc] to return to previous menu.

The second line of the display indicates the status of the external control input. When the paging control input is active, it will be displayed as present. The paging control input will have not control over the state of the paging audio while in this test.

The paging audio path may be checked by entering an 'N'. This will cause all of the paging audio configuration level information to be loaded into the audio zones, the zones unmuted and the paging audio routed through to the zone outputs. The paging duration timer will be operative if it was set, and upon it's expiration the audio zones will return to their previously muted state.

6) Turn on/off source power? [off]

This is a way of turning on and off the relay that provides power to the source receptacle on the rear panel. Choosing this menu item toggles the status of the relay, and redisplayes the current status of the relay on the menu line.

7) Turn on/off amp power? [off]

This is a way of turning on and off the relay that provides power to the amplifier receptacle on the rear panel. Choosing this menu item toggles the status of the relay, and redisplayes the current status of the relay on the menu line.

Troubleshooting

*W*hile The Director Model 46 has been designed to be easy and trouble free to install, we recognize that this may not always be the case, usually due to some outside circumstances beyond our control. In designing The Director Model 46, we tried to keep the potential problems that you may run into in an installation and tried to either eliminate the problems for you if we could, or to give you the tools that you would need to solve the problem if we couldn't eliminate it.

There are several key points that we feel are of the utmost importance to quick, successful troubleshooting. Even if you are an experienced installer, it may pay to review these notes. First and foremost is the need for a logical, systematic approach to finding the problem. If you go about checking things at random, without consideration for the relationship between the problem at hand and the thing that you are checking, the results can just be an exercise in frustration. For example, if source 2 is a CD player, and the machine control commands don't seem to be working for it, you wouldn't go checking the audio cables coming from the tuner.

The second key point is that troubleshooting often revolves around eliminating the things that are working, leaving an ever shrinking list of possible suspects to check. A helpful way to look at the problem is to make a list of suspects, in order of likelihood. The items that should be on the bottom of the list are things that are totally unrelated to the problem.

A third quick point is to separate actual hardware problems from system configuration problems. Since The Director Model 46 is so flexible and can be setup to do so many things at the push of a station button, is possible to create macros on station buttons that instruct the Director to things that not only result in unexpected behavior, but result in behaviors that appear to be hardware related. Fortunately, we've provided a way for you to bypass all of these potential problems during troubleshooting so that you can verify that the problem is confined to the hardware or that the hardware works fine and you need to go back through the system configuration. In the system configuration menus, The Director Model 46 has a submenu for testing each of the individual hardware subsystems, including the machine controls and the audio path of the Director. Using an external computer with terminal emulation software such as Telix, Procomm, or any other package with VT-100 emulation and Zmodem file transfer. You can use the System Diagnostics submenu (item 6 on the MAIN MENU) to go through all of the external hardware connected to the Director. A quick look at what can be tested from this menu is:

Item 1 - Test station network and report all stations found: This menu item runs a complete communication diagnostic on the LiteTouch station network and all stations that are connected to it. It verifies that the station network has power, that the station network cable capacitance is not too high to permit communications with the stations, and then tests the ability to communicate with all of the stations, both with all the leds off and with all the leds on. Finally it gives a report screen that displays the station addresses that were found on the network, comparing them with the station addresses that the Director is currently programmed for, and the communication status of each of the stations.

Item 2 - Interactive station identification: This menu item is used to allow you to identify the address of a station that has already been installed in the wall without removing the station from the wall. Since there are times when the manner in which a station has been attached to the wall makes removing it difficult (not a recommended practice, by the way, but these things do happen). By entering this menu item and then going to the station in question and pushing a button on the station, the Director will report back the address that the station is programmed to and the button that was pressed.

Item 3 - Test the audio path of a zone: This menu item allows you to select a zone and source, set the input gain for that source, set the volume, bass, treble and balance, and unmute the zone. You can then verify the operation of the equipment connected to the zone output using the actual source that you've selected.

Item 4 - Test the machine control commands and interfaces: This menu item allows you to exercise the machine commands that you have set up for a selected source. In addition, this also allows you to verify that the method that you are using to get the commands from the Director to the source works.

Item 5 - Test the paging subsystem audio and control paths: This menu item allows you to test the paging audio input and it's connected signal source, along with the control input. The status of the control input is indicated on your computer screen. The audio path can be toggled between the paging input and the normal mode of operation. While the paging input is selected, all of the configuration information that is part of the paging subsystem is also brought into play, including both the levels that were configured and the options of paging through a muted zone or not. This allows you to check that the proper paging behavior has been configured.

Item 6 - Turn on and off the power for the sources:

Item 7 - Turn on and off the power for the amplifiers: These options, while self evident, need a little explanation. Selecting one of these items toggles the state of the respective power receptacle on the rear panel and the state of the DC control voltage output on the rear panel. While the obvious is that it allows you to turn on and off the source and amplifier power so that you can run some of the other tests above, it also is a necessity for troubleshooting remote power control relays and their associated wiring when you have remotely located amplifiers and/or sources.

Using the above test items can also speed a normal trouble free installation by allowing you to test each of the subsystems as you install them. Real useful in rack installations with limited access. Which also means that you can fix things that may have gone wrong as they occur, instead of after the fact.

Things to Look For

Since it is impossible to cover every conceivable problem that may crop up, we'd like to give a few examples and show how we'd go about finding the cause of the problem.

Example 1:

The stations won't communicate with the Director.

Station network problems are easy to solve if approached in a straight forward, logical manner. The first thing to know is what the behavior of the Director with regard to the station network is when it first powers up, or is reset via the front panel accessible reset switch. The Director Model 46 does a simple preliminary test of the station network to see if it is going to be able to communicate with the stations. It does this by testing to see if the capacitance of the cable and connected stations is within acceptable tolerances, that there is power present on the station network connector and that the data line on the station network is not shorted to either power or ground. If there is a problem with the data line, either too much cable capacitance or a short to either power or ground, the status led will blink in a pattern of one half second on, one half second off, one half second on, two seconds off. If the station power is not present the status led will be dark. If all is OK with the network, the status led on the front panel of the Director will blink in a one second on, one second off pattern for 10 seconds. At the end of the 10 seconds, there will be a burst of blinks from the status led indicating that the Director is updating all of the stations that it has been configured for.

One of the first things that can be done when trying to sort out station network problems is to run the Test station network and report all stations

found test on the System Diagnostics submenu. This will check the condition of the power on the network, verify that the cable capacitance is within acceptable limits and isn't going to hinder communications with the stations, and then scans the station network for station addresses. Each station address that is found is checked against the list of station addresses that the Director has been configured to work with, and separated out for later reporting which station addresses are valid and which have not been entered.

Station network problems can be broken down into a few categories:

- 1) One station unresponsive, however the leds on the station light while a button is being pressed. This is a good indicator that the station is getting power, but the station has no data communications with the Director, or the Director is ignoring the station because the Director has not been configured for this station's address due either to the station not being set to the address it is supposed to be or the Director hasn't been configured with this station's address and macros for the station's buttons. A quick check for this is to run the Interactive station identification test in the System Diagnostics submenu, and press a button on the unresponsive station, while the test is running. The test will display the address of the station and the number of the button that was pressed if the Director is seeing the station data. If the Director is receiving the station's data then you need to take a look at the station configuration assignments to see if the station's address has been entered and that there are macros assigned to the station's buttons. If in fact the address that the station says it's set to and the address that the Director was configured for don't agree, you don't have to remove the station from the wall to readdress it. Simply go to the Station Configuration submenu and use the address change function to change the address from what the Director was configured for to the actual address that the station is set to. Nice, eh? If on the other hand, the Director doesn't see the button press you need to look for an open connection to the network data line (station pigtail blue wire). This may be as simple as a broken wire at a splice in the station's back box, or at the next box closer to the Director that the station network cable is routed to. It could be as much of a headache as a broken wire inside a wall. You did keep good notes on what cable went where, right? A final possibility is that the station is defective and can't communicate on the network. The only way to really test this is to swap out the station with one that is known to work, resetting the address on the test station to whatever the address was on the station that is giving you problems.

- 2) One station unresponsive, no leds light on the station when their buttons are pressed. This is a good indicator that either the station itself is totally dead or that the station is not receiving power. After removing the station from the wall (sorry, the fix is not as easy as the one for misaddressed stations...), and verifying that there are no broken wires, and that the station is plugged into the network, you may wish to take out your voltmeter and measure the voltage between the power (pigtail red wire) and common (pigtail black) wires, which should be approximately 15 volts DC, and also measure the voltage between the data line (pigtail blue wire) and common (pigtail black wire), which should also be within one volt of the network power voltage. If the right voltages are present, then you've got a dead station, which can only be fixed by replacing it and returning the dead one for repair. One give away as to a dead station is that the back metal plate of the station, which functions as the heat sink for the station's voltage regulator, is very warm or even really hot! This is a sign that the station is in serious trouble and needs to be replaced. However, if the voltages are not correct or even present then you have a wiring problem with the station network cabling. It could be as simple as a broken wire at a splice in one of the station back boxes or as difficult as a break in the cable inside a wall. You did ring out the cabling before and after the sheet rock was put up, right?
- 3) Some or all of the stations are unresponsive, however the leds on the station light while a button is being pressed. This is a multiple station version of item 1. Either the data line is not connected between the Director and the section of network cabling that the stations sit on, all of the stations are not correctly addressed, or the Director isn't configured for this group of stations. Using your paper work where you have documented how the cables are run through the house, you can go to the station that is closest on the network to the Director and begin your troubleshooting there. You may wish to disconnect all of the stations down stream of the current station to verify that the current station can get back to the Director.
- 4) Some or all of the stations are unresponsive, no leds light on the station when their buttons are pressed. This is a multiple station version of item 2.
- 5) All the stations appear to work intermittently or only for a short period of time after powering up the Director. This is accompanied by the status led going out about the same time as when the stations stop working. This is an indication of either an intermittent short circuit or an overload on the station network power supply. The

Director Model 46 has a current limited power supply that feeds the station network. The power supply overcurrent protection will trip if there is more than 2.5 amps being drawn on the station network. You may wish to double check each back box to make sure that there are no possible causes of a short circuit between the power and common wires. Things to look for are uninsulated sections of wire or a stray strand that didn't get covered by the splice insulation. It is also possible that a defective station will draw excessive amounts of power and trip the short circuit protection. The short circuit protection is self resetting upon removal of the cause of the short. If you run the Test station network and report all stations found diagnostic after the status led goes out, it will stop if it finds that the station network power is not present.

A quick note about cable capacitance:

The LiteTouch station network topology has a limitation as to the amount of cable capacitance that is acceptable before the data won't get through. The station network works fine over runs of 18/4 unshielded cable in lengths of 500 feet or more. If the installation calls for really long runs of cable, it is better to daisy chain a number of stations together while trying to keep the cable runs to a minimum length. If the resulting cable capacitance as reported by the Director when it powers up or when it runs the Test station network and report all stations found test, don't think all is lost. A simple fix for almost all occurrences of this problem can be accomplished by installing a 4.7K 1/4w 5% resistor (with the leads suitably insulated) at each station between the power (red pigtail wire) and data (blue pigtail wire) lines.

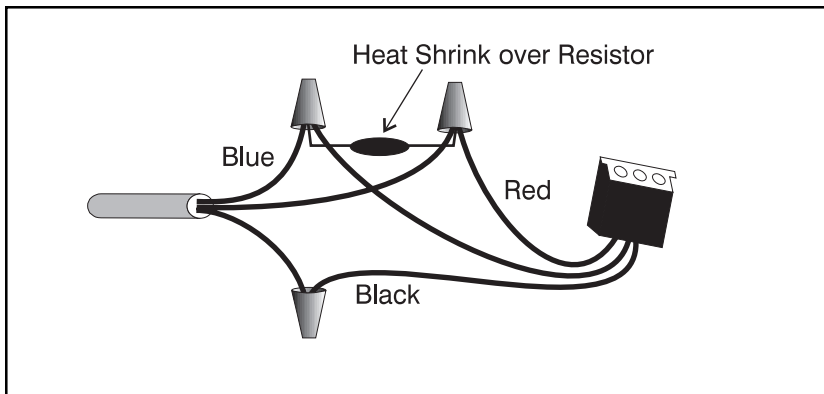

Example 2:

The left speaker in zone 3 has no output, the right speaker works fine.

Our list of possible suspects includes:

- The speaker cables and the connections to the speaker and amplifier output.
- The speaker itself.
- The amplifier channel for zone 3.
- The interconnect cable between the amplifier channel and the output of the Director
- The macro configuration for the station or stations that are controlling zone 3.
- The Director itself.

We have two options on where to start on this list. Because this type of problem could be caused by having a stereo zone set up in split mono mode with the respective confusion in the macro configuration for the stations that are in control of this zone, it may be quicker to first double check that the problem is hardware related. This can be done by using the third option from the System Diagnostics submenu which will allow us to exercise the audio path for zone 3 and determine if the problem is external to the Director, or if we need to have a further look at the macros on the stations that control zone 3. This is a real time saver if you have custom configured all of your macros on all of your stations, and you have some zones that are set up to operate in split mono mode.

Our second option is to check all of the external equipment first, making sure that everything is in working order and properly connected, and then investigating the Director and the macro situation. This is probably the best option if you are working with the factory default configuration and are having troubles getting a zone to work. In this situation the probability is that the problem lies in the external equipment.

Starting at the top of the list, first we need to check the connections to the speaker and the amplifier channel. Now, while this seems simple, we all know that the wire that looked like it was connected to the back of the speaker may have come off as we put the speaker into the soffit mounted back box. A quick way to check the health of the cable and the presence of the speaker on the end of the cable is to disconnect the wires from the amplifier channel and either check the resistance with an accurate meter with a sensitive low ohms scale looking for the DC resistance of the speaker on the pair of wires, which for an 8 ohm speaker is typically 5 to 6 ohms. While you are disconnecting the speakers, take a look at the way that the connections were made to the amplifier. Were they good connec-

tions? Tight? None of the insulation from the wire caught under the binding post? If so, then one possible trouble spot has been cleared of suspicion. If you only see a reading in the neighborhood of 1 or 2 ohms, it is possible that the cable has a short circuit. A quick comparison check against the other channel of the zone will help verify this. And of course a reading of infinity indicates that the speaker is not connected, or that the wire is broken. Another quick check is to use a 1.5 volt flashlight battery and a couple of clip leads to 'click' test the speaker. If you use this method, please, please make sure that you disconnect the speaker wires from the amplifier. It may also be a good idea to disconnect the pair of wires to the other speaker on that zone if the speakers are wired with 4 conductor cable. By the way, one thing that we've seen as a common problem is when an installation has the speaker cabling run as 4 conductor cable where 2 wires are used for the left side and 2 wires are used for the right side. A common problem is when one person has responsibility for connecting up the amplifier outputs and another person is responsible for connecting and installing the speakers. If the two people don't use the same color code at each end, it just won't work! Obvious, right? Not so when the speakers are being installed by the electrical contractor, and the amplifiers are being wired by an A/V type installer. Each group looks at the standard red/black/green/white color code differently. You did get the chance to ring out the cables before the walls were closed up, right?

So, if you find that the wires appear to be shorted or open, then we need to get out the ladder and get up to the speaker in question and get it out of it's soffit mounted back box. (Murphy's law guarantees that the problem speakers will always be the ones on the highest ceiling, or in the most difficult to get to location - all the more reason to double check them when putting them in the first time.....) If a visual inspection hasn't ruled out the cause of the problem, such as the wire coming loose when the speaker was installed the first time, a quick check with the meter or the battery and clip leads will show that the speaker either works or is the culprit.

Okay, so the speakers and cabling check out. Reconnecting the speakers to the amplifier outputs, we move on to amplifier and upstream items, eliminating the first 2 items on the check list. And since we are here, this means that the original speaker wire/amplifier connections weren't the cause of the problem (or you just like reading this stuff). Now is a good time to do a little quick sanity check to make sure that all of the moving around of wires and such didn't "fix" the problem. Problem still there? If not, then we have a choice to make - try to make the problem show up again, and find the cause; or to forget about it, sweeping it under the rug so to speak. We also know that ignoring it will result in a call back from the client at the time that is most inconvenient to us. So, moving on, the next

thing to do is to swap the left and right inputs to this zone's amplifier, to see if the problem moves from one channel to the other. Do we still have no output on the left speaker? If so, then the amplifier channel is bad and we need to service or replace the amplifier. If the problem moved to the right channel, then the amplifier is OK, and can be crossed off of the above list of suspects, and the left and right interconnect cables can be moved back to their respective channels.

Moving to the back of the Director, we next swap the left and right cables going to the zone 3 amplifier. If the problem moves, then it is a bad interconnect cable. Otherwise we are at the point where we have to determine if the problem is related to the macros and configuration for zone 3 or with the Director hardware itself. So if you haven't run the System Diagnostics option 3, Test audio path of a zone, then now is a good time to do so. This will allow you to quickly determine if the problem is a configuration error, or is actually a Director hardware failure. If both channels work while using the diagnostics but refuse to work with the stations you need to double check the configuration of the macros and of the zone. It is important to only use the mono volume up, volume down, mute and unmute macros for their relative left or right sides of a split zone when the Director is configured to split the zone. If the mono macros are used with a stereo zone or the stereo macros are used with a zone that is set for split mono operation, the Director ignores the macro elements that are wrong. This is an easy mistake to make, especially if you are reconfiguring a Director as a result of last minute changes requested by the homeowner.

In the unlikely event that it is really a hardware failure of the Director you will need to contact your AudioControl representative or the AudioControl factory to arrange for repair or replacement.

Example 3:

No machine control or wrong machine control functions of a source.

The Director Model 46 has the ability to control source equipment via either a direct control input or by using an IR emitter. Each of the four sources has its own machine control output, and each output can be independently configured for IR emitter or direct input operation. The difference between the two modes of operation is simply the enabling or disabling of the high frequency carrier used in the IR mode to send the control information. There are exceptions such as the Parasound tuner where the IR control mode must be used with their direct input control jack, as the jack connects to an internal IR emitter.

Our troubleshooting list for an IR controlled source would look something like this:

- ❶ IR emitter not connected to the Director source control output.
- ❷ The IR carrier is turned off for this source in the Director machine control configuration.
- ❸ IR emitter output not hitting the IR receiver on the source.
- ❹ Source's IR receiver being overloaded by the IR emitter at close range.
- ❺ IR emitter is defective.
- ❻ The Director is configured for the wrong source type or manufacturer.
- ❼ The source equipment manufacturer has changed the machine control codes between models.
- ❽ The source equipment isn't supported in the current Director machine control library.
- ❾ The source equipment is defective.
- ❿ The macros controlling the source have configuration errors in them.

If possible (and as a quick sanity check) you should verify the proper operation of the source equipment with the manufacturer supplied IR remote control. This eliminates the possibility of defective source equipment, unlikely as it might be.

A quick visual inspection should eliminate the possibility that the IR emitter is not plugged into the correct IR control output on the back of the Director.

A quick check in the machine control configuration submenus should be made to make sure that the IR carrier is turned on for this source. Without the carrier being turned on, the Director will only send out the control pulses, which will not be detected by the source equipment when using IR control.

The Director Model 46 has a diagnostic to assist with troubleshooting just these types of problems. Located under the System Diagnostics submenu is a menu item entitled Test the machine control commands and interfaces. This submenu allows you to select one of the 4 sources and then send any one of the 16 machine control commands that have been configured for the source by entering the number of the command. You can do this as many times as necessary until you have the machine controls working properly. We suggest that you use this feature to help you determine if the problem is with the machine control side or the macro configuration side of the system. This diagnostic will also show you the source type that

has been configured, which will allow you to quickly determine if it is a configuration error or a possible hardware problem.

Using the machine control diagnostic, and starting at the top of the list, the first thing that we suggest is to take the IR emitter and hold it away from the source by about 2 feet, point it at the source and try the machine commands. The IR emitter will have a much wider shot at the front of the source, and will not be as strong as it normally is at point blank range. If at this point the source starts responding to commands you can move in closer, homing in on the equipment's IR receiver window. If the source stops working once you are at point blank range, it is possible that the IR emitter is overloading the source's IR receiver. The Xantech IR emitters that we supply with the Director include a small cover for the emitter that attenuates the infrared light output of the emitter so as to help eliminate the overload problems. Please refer the instruction sheet included with each emitter.

If all of the above checks out and the source is still unresponsive to the machine commands sent using the diagnostic menu, it is possible that the manufacturer has decided to change the IR codes that control the source. While this is unlikely when it is the same make and model that you used in the last installation (which worked perfectly), it is possible, especially if the manufacturer has OEMed some of the internal subsystems and changed suppliers. This type of thing is more prevalent when the manufacturer changes models. This year's model may not work with last year's remote control, for what ever reason. Some manufacturers are more consistent model to model than others. You may need to contact the AudioControl factory for additional assistance with this type of problem.

A different but similar problem is when the source checks out with the diagnostics menu, but doesn't seem to respond to the proper station button presses. This is an indication that the machine commands that are assigned to the macros on the buttons are not the right ones (stop being sent instead of play). A review of what the actual command numbers (1 to 16) and their respective command assignments will be necessary to further understand what you have configured a macro to do. Keep in mind that it is completely possible to send a machine a play command followed by a stop command in a macro. Needless to say, the machine will never go into play for any great length of time!

Our troubleshooting list for a directly controlled source would look something like this:

- ❶ Machine control interface not connected to the Director, the source, or a source of power.
- ❷ The IR carrier is turned on for this source in the Director machine control configuration.

- ③ Machine control interface is defective.
- ④ The Director is configured for the wrong source type or manufacturer.
- ⑤ The source equipment manufacturer has changed the machine control codes between models.
- ⑥ The source equipment isn't supported in the current Director machine control library.
- ⑦ The source equipment is defective.
- ⑧ The macros controlling the source have configuration errors in them.

A number of the key points in troubleshooting a directly connected source are the same as an IR controlled source. One thing is that the System Diagnostics menu in the Director configuration mode is your servant, in that it will allow you to send the machine commands to the source with out going through any of the macros that are configured on the stations.

As in troubleshooting an IR controlled source, the first thing is a quick sanity check with the IR remote control supplied with the source equipment. This will verify that the source equipment is working as you expect and that you need to look further at how you have set up the machine control with the Director.

A visual inspection of the connections between the Director, the machine control interface and the source equipment should be made. If there is a common power supply used for multiple machine control interfaces, the connections to the interface for the non-working source should also be checked. If the power for the interface should be checked with a voltmeter. If all this checks out and another interface is available, you may wish to test by substitution.

Speaking of machine control interfaces, are you using the correct interface for the source, and if it has configuration options are they set according to the manufacturer's directions for the particular piece of source equipment? If you are directly connecting the Director to the machine control input of the source equipment, is your cable wired correctly?

One of the things that will be displayed while using the Test the machine control commands and interfaces diagnostic is the type of source that the Director has been configured for. Needless to say, it is silly to try to control an RC5 tuner with a Sony CD player command set. This is an easy error to make if you have modified the factory default configuration, and forgot to change the source equipment selections to match your sources.

The remaining possible sources of difficulty are the same as in the IR example above. In the case of the possibility that the manufacturer has changed the machine control commands between source model years, you will need to contact AudioControl for more assistance.

The issue of the source equipment functioning with the diagnostics, but not working with the station button macros means that you need to review the machine command assignments and their use in the respective macros.

Getting HELP!

Hopefully the above examples have given you some insight into troubleshooting a Director system. If you find yourself with a problem that doesn't seem like it has any logical explanation or solution, we at AudioControl are here to help. There are people at our factory who are available by telephone to discuss the problem with you. You may contact us at 425-755-8461, Monday through Friday, 8:00 AM to 5:00 PM PST.

Warranty

P People are scared of warranties. Lots of fine print. Months of waiting around. Well, fear no more. This warranty is designed to make you rave about us to your friends. It's a warranty that looks out for you and helps you resist the temptation to have your friend, who's "good with electronics", try to repair your AudioControl product. So go ahead, read this warranty, then take a few days to enjoy your new The Director Model 46 before sending in the warranty card and comments.

"Conditional" doesn't mean anything ominous. The Federal Trade Commission tells all manufacturers to use the term to indicate that certain conditions have to be met before they'll honor the warranty. If you meet all of these conditions, we will warrant all materials and workmanship on the Director Model 46 for one (1) year from the date you bought it, and we will fix or replace it, at our option, during that time.

Here are the conditional conditions:

1. You have to fill out the warranty card and send it to us within 15 days after purchasing the Director Model 46.
2. You must keep your sales receipt for proof of purchase showing when and from whom the unit was bought. We're not the only ones who require this, so it's a good habit to get into with any major purchase.
3. The Director Model 46 must have originally been purchased from an authorized AudioControl dealer. You do not have to be the original owner, but you do need a copy of the original sales slip.
4. You cannot let anybody who isn't: (A) the AudioControl factory; or (B) somebody authorized in writing by AudioControl to service the Director Model 46. If anyone other than (A), or (B) messes with the Director Model 46, that voids your warranty.
5. The warranty is also void if the serial number is altered or removed, or if the

Director Model 46 has been used improperly. Now that sounds like a big loophole, but here is all we mean by it:

Unwarranted abuse is: (A) physical damage (don't use the Director Model 46 to level your projection TV); (B) improper connections (120 volts into the RCA jacks can fry the poor thing); (C) sadistic things. This is the best product we know how to build, but if you strap it to the front bumper of your Range Rover, something might break.

Assuming you conform to 1 through 5, and it really isn't all that hard to do, we get the option of fixing your old unit or replacing it with a new one.

Legalese Section

This is the only warranty given by AudioControl. This warranty gives you specific legal rights, and you may also have rights that vary from state to state. Promises of how well the Director Model 46 will work are not implied by this warranty. Other than what we've said we'll do in this warranty, we have no obligation, express or implied. We make no warranty of merchantability or fitness for any particular purpose. Also neither we nor anyone else who has been involved in the development or manufacture of the unit will have any liability of any incidental, consequential, special or punitive damages, including but not limited to any lost profits or damage to other parts of your system by hooking up to the unit. Whether the claim is one for breach of warranty, negligence of other tort, or any other kind of claim. Some states do not allow limitations of consequential damages.

Failure to send in a properly completed warranty card negates any service claims.

The warranty included with the unit shall supersede this plain-text version, if there is any inconsistency between the two.

What to do if you need service

First, contact AudioControl, either by phone 425/775-8461 or FAX 425/778-3166. We'll verify if there is anything wrong that you can fix yourself, or arrange to have it sent back to our factory for repair. Please include the following items with the returning unit:

- 1) A copy of your proof of purchase (that sales receipt we've been harping about). No originals please. We cannot guarantee returning them to you.
- 2) A brief explanation of the trouble you are having with the the Director Model 46. (You'd be surprised how many people forget this.)
- 3) A return street address. (No PO Boxes, please)
- 4) A daytime phone number in case our tech has a question about the problem you are having.

You're responsible for the freight charges to us, but we'll pay the return freight back. We match whatever shipping method you send it to us, so if you return the unit overnight freight, we send it back overnight. We recommend United Parcel Service (UPS) for most shipments.

Service Information



WARNING: There are no user serviceable parts inside the The Director Model 46. Lethal voltages are present inside the case. Refer all servicing to qualified service personnel.

Repair service is available at:

AudioControl®

Attn: Service Department
22410 70th Avenue West
Mountlake Terrace, WA 98043 USA
(425)775-8461 • FAX (425)778-3166
e-mail: service@audiocontrol.com

System Specifications

Component Type	Line-Level Audio Multi-Room Controller
Signal to Noise	Greater than 95 dB (A-weighted, ref: 1 Vrms)
Distortion	0.01% Total Harmonic Distortion
Tone Controls	Digitally Controlled, Baxandall Topology
Bass	±12dB @ 100 Hz
Treble	±12dB @ 10 kHz
Level Control	78dB stereo, 38dB mono in 1.25 dB Steps
Mute Level	Programmable
Source Inputs	Four, stereo paired
Connector	RCA Jack
Input Level	4Vrms Max - Programmable
Input Impedance	100 kilohms
Zone Outputs	Six, stereo paired; or 12 mono zones (Stackable to 12 stereo, 24 mono zones)
Connector	RCA Jack
Output Level	4 Vrms Max
Output Impedance	150 ohms
Source Control Outputs	
Type	Infrared LED Flasher or Direct-wire Control-S
Connectors	Four, 1/8" mini-plug
Control Codes	Major Brands Resident (Additional Downloadable)
Wall Control Stations Network LiteTouch Serial Bus	Standard LiteTouch
Mounting	Full Sized Single Wallbox
Recommended station wire	18 gauge, 4 conductor
Control Buttons	LiteTouch: 9
Maximum Stations	16
Paging Input Connector	RCA
Paging Input Level	500mVrms Nominal, 4 V Max
Paging Control input	Type-C Inverted Fusion Converter*
Paging Mute Level	Programmable
Microprocessor:	Dual CMOS MicroControllers
Memory	Non-Volatile EEPROM
Programming Port	DB-9F, RS-232 Serial
Programming Fuel	Double Tall Latté
Port Settings	Auto-Baud Rate, 8 bits, No Parity, 1 Stop bit
System Protection	Network Short-Circuit / Overload / Transient
Electrical	Line Voltage: 105-125Vac, 60Hz
Power Consumption	1250 watts maximum
Switched AC Outlets	Two independent, 1200watt combined maximum load
Physical	3.5"h x 17.25"w x 12.5"d Standard 2 space (3.5") 19" rackmount optional
Weight	12 pounds
Warranty	5 Years or 2,629,440 Minutes
Country of Origin	U.S.A.

*contact closure or 8-35 VDC, 6-24 VAC

Architectural Specifications

The control system shall be a unit containing a line level audio routing matrix consisting of 4 stereo line level inputs and 6 stereo line level outputs. Each stereo line input shall be assignable to any number of zones without change in signal level.

Each stereo line level input shall have an independent input gain selector which shall be adjustable from 0db of gain to +18db of gain in increments of 6db.

Each line level output shall have a level control capable of a range of -70db to 0db, and mute. Each zone shall have independently adjustable minimum, maximum and default volume levels. Setable by the installer during system programming. Each zone shall be installer configurable for either default volume level or last set volume level.

Each line level output shall have dealer adjustable electronic bass and treble controls.

Each line level output zone shall be splittable from one stereo output into two mono outputs with common source selection and independent level control. In mono output configuration, each output shall be controllable over a range of -38db to 0db, and include mute.

The control system shall be expandable to a 4 stereo source by 12 stereo zone installation.

The control system shall include a mono paging input and trigger input to allow paging and signaling through the zone outputs. The trigger input shall allow for either contact closure trigger or external voltage input over the range of 5 to 30 volts DC and 6 to 24 volts AC. The trigger input shall be protected against over voltages and static discharge. The trigger input shall be isolated from the audio input.

The control system shall control the line level sources via unidirectional serial commands in a format similar to the source manufacture's IR

remote control. Each source shall have it's own independent IR control channel.

The control system shall carry on board the IR control codes for the most popular source units. Additional IR control codes shall be installer programmable in the field.

The control system shall be operated via wired control stations or wired IR receivers. The system communicates with standard control stations manufactured by LiteTouch.

The control system shall contain an RS232 serial port for the purposes of programming by the installer and control of the system by an external means. External control equipment shall interface using the built-in command language of the control system, of which the commands shall be in human readable format at all times.

The control system shall be programmable in all system functions and parameters. All programming shall be done utilizing a standard terminal emulation program running on a portable computer and communicating utilizing the build-in RS232 serial port. The control system shall contain all software necessary to communicate with said terminal or emulator.

The control system shall include two separately switched AC outlets and two remote relay output connections paralleled with the control signals for the AC outlets. One AC outlet and relay output shall be for connection of line level source equipment, the other AC outlet shall be for connection of a multi channel amplifier. The amplifier outlet shall have an adjustable turn-on delay, to start after the source outlet has turned on. The adjustment range shall be from 0 to 60 seconds in increments of 1 second.

The control system shall carry a five year warranty.

Rear Panel Connectors and Signal Information

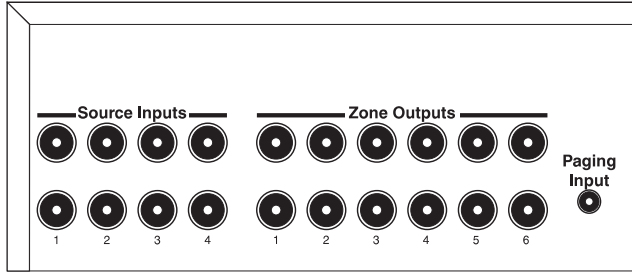
**Audio Connections**

All audio inputs and outputs are unbalanced, line level and appear on RCA connectors on the rear panel.

Source Audio Inputs:

The first, left most group of double row RCA connectors are the Source inputs. The top row are the left inputs and the bottom row are the right inputs. Each input has an input impedance of 100k shunted with 100pf for RF suppression. Maximum signal level is $4V_{RMS}$.

Zone Audio Outputs:

The zone output connectors are the second group of double row RCA connectors on the back panel. There are six zone outputs, each with the left channel on the top, and the right channel on the bottom. The output impedance is 150 ohms. Max line level output is $4V_{RMS}$.

Paging Input:

The paging input located to the right of the zone outputs. It is a mono, line level input with an input impedance of 100k, shunted with 100pf for RF suppression. Maximum signal level is 4V RMS, with a desired nominal level of 500mV.

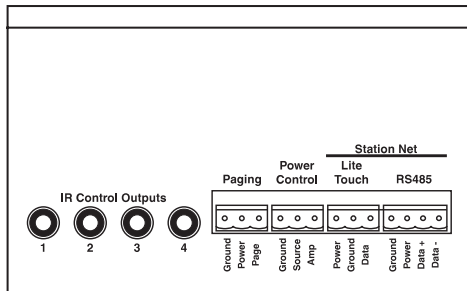
**Control Connections****IR Control outputs:**

There are 4 IR control outputs for connection to industry standard IR emitters such as those available from Xantech. Connection is provided via 1/8" mini jacks, with the tip of the mini plug being the positive (anode) connection to the emitter and the sleeve contact of the mini plug being the negative (cathode)

connection to the emitter. The emitters are driven with a constant current source that provides 20 milliamps of current to the emitter.

Paging Input Control:

The paging input is controlled by the paging input control connector. This 3 terminal block has the following connections:

- Pin 1: control ground
- Pin 2: +12 volt control power output
- Pin 3: control input (positive)

The control input can be actuated by the application of a voltage in the range of 6 to 30 volts DC, or 8 to 24 volts AC between the control input and the control ground terminals. When a DC control voltage is used, the control input (pin 3) is the positive terminal and the control ground (pin 1) is the negative terminal.

Contact closure such as a switch or relay contact can also be used to control the paging input. When using a contact closure, the contacts are connected between the control input (pin 3) and the control power (pin 2). The contact closure must be capable of dealing with a low current signal of 10 mA.

There are several programmable options associated with the paging control input. Please see the programing manual section on paging input control for more

information on programming the input for: alternate action momentary or maintained, minimum closure time, minimum page time, release delay, etc.

Input is over voltage protected, limited to 36 volts peak.

External Power Control

The terminal block labeled 'External Power Control' provides the same relay coil power as the two internal relays in the Director. One relay is for source power control, the other relay is for power amplifier control. Relays with 12 volt coils may be used, or as an alternate, a DC control solid state relay may be used. Either or both relay outputs may be used so long as the total coil current of both relays does not exceed 500ma. Coils should be rated for 12 volts DC.

Relay terminal block connections are as follows:

Pin 1: Ground (negative)

Pin 2: Source relay (+12 VDC) output

Pin 3: Amplifier relay (+12 VDC) output

Outputs are fault limited to 1 amp maximum fault current.



CAUTION

When using the Lutron station network, a jumper wire must be connected between the LiteTouch data line and ground for proper operation!

Station Network Connections

There are two station network connectors, one for LiteTouch stations and one for RS485 stations. Only one network (LiteTouch or RS485) may be used a time.

LiteTouch connector pinout:

Pin 1: Positive power supply - Unregulated 15 VDC, current limited to 2.5 amps maximum.

Pin 2: Ground

Pin 3: Bidirectional data line.

Note that this connector has the same pinout as the LiteTouch CCU station network connector.

RS485 Station Network connector pinout:

Pin 1: Ground

Pin 2: Positive power supply - Unregulated 15 VDC, current limited to 2.5 amps maximum

Pin 3: Bidirectional data line positive

Pin 4: Bidirectional data line negative

Note that RS485 station network is not supported in the current version of the software.

Serial Port

RS232 port and programming switch:

The RS232 port supports the following RS232 communications lines:

- Pin 2: Transmit data to external device
- Pin 3: Receive data from external device
- Pin 5: Ground

All other port pins are not connected. Baud rate is set automatically upon entry to the programming mode, and can range from 1200 baud to 57600 baud. Data format is 8 data bits, no parity, 1 stop bit.

When using the RS232 port to control the Director from another automation system, the baud rate may be locked to a specific rate. Please see Section 4-10 in the System Configuration Section for more information.

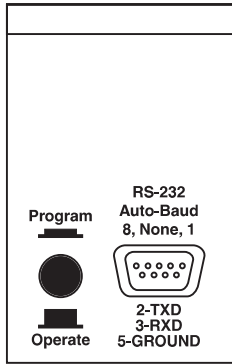

AC Power Outlets

Source and Amplifier power outlets:

The top outlet on the rear panel is for controlling power for the sources. The bottom outlet is for controlling power for the amplifiers. Each outlet is capable of controlling a maximum of 1200 watts, however the combined power consumption of both receptacles must not exceed 1200 watts. Each receptacle is controlled by a high inrush rated relay, capable of handling the full startup current of today's modern amplifiers.

Power cord should be plugged into a standard 120 VAC circuit. It is highly recommended that the Director and it's companion equipment be connected to a separate circuit dedicated to the

audio system. The Director is fully protected internally against surges and external power line related interference.

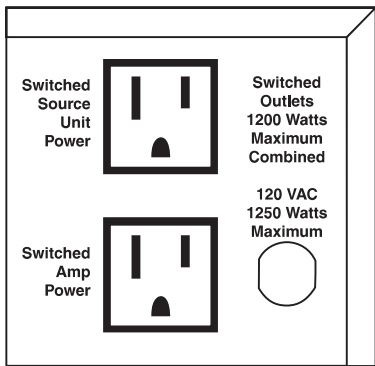

CAUTION

The Director DOES NOT provide filtering or surge suppression for external devices connected to the power outlets!

Software Revision History

Important note about software versions: The version number contains a major version number, a minor version and an internal revision number. The first digit (2.xx) represents the major version, and is changed when significant changes are made to the software. The additions of major new features or major changes in the way that the Director system works will result in a change of the major revision number. The minor (x.0x) revision number is changed when ever we add some small new feature to the Director, typically a new menu item. The internal revision number (x.x1) is changed when we make changes internal to the Director software that do not show as another feature or addition.

- V1.00** • Good, ole' #1 - first version, not released to production or the outside world. Post CEDIA and CES comment analyzation required substantial revisions. Not quite as buggy as an ant hill, but better than most of the stuff you get from a very large, unnamed Northwest software company.
- V2.00** • Final release version.
- V2.02** • Fixed error in factory default configuration - assignment of "If Zone 2 Source then" on stations 1 and 4.
- Fixed bug with Parasound type 2 and selection of machine command assignments.
- Changed all 'programming' strings to say 'configuration' making menus and documentation uniform.
- Added version number to menu screens.

Current IR Control Codes Available

The Director Model 46 IR control library internal to the Director features the control codes for tuners, cassette and DAT tape decks and CD players from the following manufacturers:

Carver

All RC5 controlled sources

Marantz

All RC5 controlled sources

McIntosh

All commands on their unified remote control

Parasound

Phillips

All RC5 controlled sources

Sony

CD players, Tape and tuner.

Yamaha

For additional information on IR source control, please contact your Audio-Control representative.

Available LiteTouch Wall Station Configurations

The LiteTouch wall control stations are available in an almost unlimited variety of finishes and button styles. The key caps are custom engraved to your specifications to ensure the legends will outlast the home.

Installation Tip:

When ordering wall stations for your installation, make certain you use the AudioControl wall station order form. With so many possible station configurations, this will ensure you get the stations build properly.

Available Wall Plate Finishes

- Black Anodized Aluminum
- Gray Anodized Aluminum
- Polished Stainless Steel
- Satin Stainless Steel
- White Primecoat Steel
- Ivory Primecoat Steel
- Satin Gold Anodized Aluminum
- 24K Polished Gold Plated Steel*
- 24K Satin Gold Plated Steel*
- Oil Rubbed Bronze*

**Premium Finish*

Available Button Colors

- White
- Ivory
- Gray
- Brown
- Black

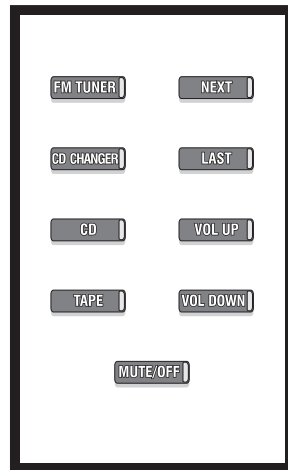

H-style Station

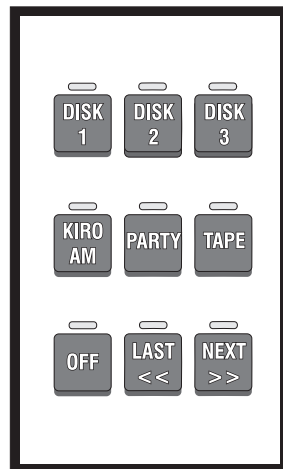
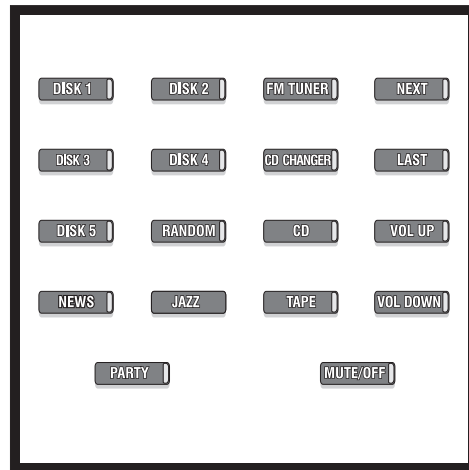

S-style Station

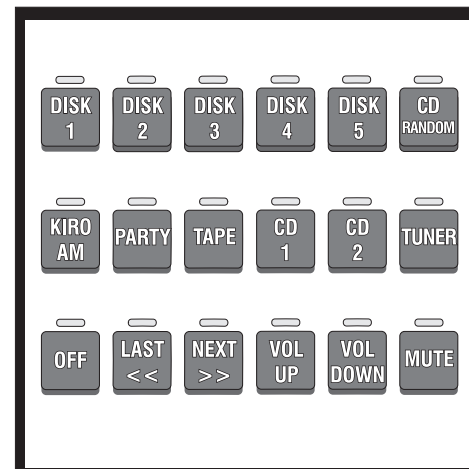

Accessories

Non-Rack Mount Front Panel - Simple 6 screw replacement for the standard rack mount front panel

IR Emitter - Self-adhesive miniature infrared LED assembly. Designed to be installed directly over the remote control window of the source unit. Includes a 10' wire with 1/8" mini-plug termination.

Programming Cable - For connecting the Director to a standard DB-9 serial port on PC compatible computer during configuration. 6' length.

Wall Station Order Form Tablet - A convenient pad of station design forms. Ensures proper station configuration.

Blank Programming Worksheet

Client Name _____ Project Name _____
 Installation Date ____ / ____ / ____ Model 46 Serial Number _____
 System Engineer _____ Archive Filename _____

System Configuration

Power Up Sequence

Source delay _____ Seconds

Amplifier delay _____ Seconds

External Control

External control	enabled	disabled						
Baud Rate	38400	19200	9600	4800	2400	1200	600	300

Source Deselect time _____ Minutes

Auto-Off Timer _____ Minutes

Paging Control Input Settings

Minimum closure duration _____ Seconds

Minimum open duration _____ Seconds

Maximum page time _____ Seconds

Paging audio settings

Page in muted zones

Zone 1	enabled	disabled
Zone 2	enabled	disabled
Zone 3	enabled	disabled
Zone 4	enabled	disabled
Zone 5	enabled	disabled
Zone 6	enabled	disabled

Page level

Zone 1	Current	RelativeMute	Absolute_____dB
Zone 2	Current	RelativeMute	Absolute_____dB
Zone 3	Current	RelativeMute	Absolute_____dB
Zone 4	Current	RelativeMute	Absolute_____dB
Zone 5	Current	RelativeMute	Absolute_____dB
Zone 6	Current	RelativeMute	Absolute_____dB

Interconnect Two Directors Yes No

This Director Master Slave

Section 7 • APPENDIX H

Source Configuration

Source 1

Manufacturer _____ Source Type _____

Control IR Direct

Input gain _____ dB

Machine command sent when deselected _____

Machine command sent at power up _____

Machine command 1 _____ Delay: _____

Machine command 2 _____ Delay: _____

Machine command 3 _____ Delay: _____

Machine command 4 _____ Delay: _____

Machine command 5 _____ Delay: _____

Machine command 6 _____ Delay: _____

Machine command 7 _____ Delay: _____

Machine command 8 _____ Delay: _____

Machine command 9 _____ Delay: _____

Machine command 10 _____ Delay: _____

Machine command 11 _____ Delay: _____

Machine command 12 _____ Delay: _____

Machine command 13 _____ Delay: _____

Machine command 14 _____ Delay: _____

Machine command 15 _____ Delay: _____

Machine command 16 _____ Delay: _____

Source 2

Manufacturer _____ Type _____

Control IR Direct

Input gain _____ dB

Machine command sent when deselected _____

Machine command sent at power up _____

Machine command 1 _____ Delay: _____

Machine command 2 _____ Delay: _____

Machine command 3 _____ Delay: _____

Machine command 4 _____ Delay: _____

Machine command 5 _____ Delay: _____

Machine command 6 _____ Delay: _____

Machine command 7 _____ Delay: _____

Machine command 8 _____ Delay: _____

Machine command 9 _____ Delay: _____

Machine command 10 _____ Delay: _____

Machine command 11 _____ Delay: _____

Machine command 12 _____ Delay: _____

Machine command 13 _____ Delay: _____

Machine command 14 _____ Delay: _____

Machine command 15 _____ Delay: _____

Machine command 16 _____ Delay: _____

Section 7 • APPENDIX H

Source 3

Manufacturer _____ Type _____

Control IR Direct

Input gain _____ dB

Machine command sent when deselected _____

Machine command sent at power up _____

Machine command 1 _____ Delay: _____

Machine command 2 _____ Delay: _____

Machine command 3 _____ Delay: _____

Machine command 4 _____ Delay: _____

Machine command 5 _____ Delay: _____

Machine command 6 _____ Delay: _____

Machine command 7 _____ Delay: _____

Machine command 8 _____ Delay: _____

Machine command 9 _____ Delay: _____

Machine command 10 _____ Delay: _____

Machine command 11 _____ Delay: _____

Machine command 12 _____ Delay: _____

Machine command 13 _____ Delay: _____

Machine command 14 _____ Delay: _____

Machine command 15 _____ Delay: _____

Machine command 16 _____ Delay: _____

Source 4

Manufacturer _____ Type _____

Control IR Direct

Input gain _____ dB

Machine command sent when deselected _____

Machine command sent at power up _____

Machine command 1 _____ Delay: _____

Machine command 2 _____ Delay: _____

Machine command 3 _____ Delay: _____

Machine command 4 _____ Delay: _____

Machine command 5 _____ Delay: _____

Machine command 6 _____ Delay: _____

Machine command 7 _____ Delay: _____

Machine command 8 _____ Delay: _____

Machine command 9 _____ Delay: _____

Machine command 10 _____ Delay: _____

Machine command 11 _____ Delay: _____

Machine command 12 _____ Delay: _____

Machine command 13 _____ Delay: _____

Machine command 14 _____ Delay: _____

Machine command 15 _____ Delay: _____

Machine command 16 _____ Delay: _____

Section 7 • APPENDIX H

Zone Configuration

Zone 1 Stereo Location: _____
Split Mono Left Location: _____ Mono Right Location: _____

Zone 2 Stereo Location: _____
Split Mono Left Location: _____ Mono Right Location: _____

Zone 3 Stereo Location: _____
Split Mono Left Location: _____ Mono Right Location: _____

Zone 4 Stereo Location: _____
Split Mono Left Location: _____ Mono Right Location: _____

Zone 5 Stereo Location: _____
Split Mono Left Location: _____ Mono Right Location: _____

Zone 6 Stereo Location: _____
Split Mono Left Location: _____ Mono Right Location: _____

Volume, Tone And Balance Settings

Zone 1 Default Last
Level Minimum _____ Maximum _____ Default _____ Mute _____
Tone controls Treble _____ Bass _____
Balance Left _____ Right _____

Zone 2 Default Last
Level Minimum _____ Maximum _____ Default _____ Mute _____
Tone controls Treble _____ Bass _____
Balance Left _____ Right _____

Zone 3 Default Last
Level Minimum _____ Maximum _____ Default _____ Mute _____
Tone controls Treble _____ Bass _____
Balance Left _____ Right _____

Zone 4 Default Last
Level Minimum _____ Maximum _____ Default _____ Mute _____
Tone controls Treble _____ Bass _____
Balance Left _____ Right _____

Zone 5 Default Last
Level Minimum _____ Maximum _____ Default _____ Mute _____
Tone controls Treble _____ Bass _____
Balance Left _____ Right _____

Zone 6 Default Last
Level Minimum _____ Maximum _____ Default _____ Mute _____
Tone controls Treble _____ Bass _____
Balance Left _____ Right _____

Station Configuration

Station Addresses

Station 1 Address: _____ Button Style: _____ Location: _____

Station 2 Address: _____ Button Style: _____ Location: _____

Station 3 Address: _____ Button Style: _____ Location: _____

Station 4 Address: _____ Button Style: _____ Location: _____

Station 5 Address: _____ Button Style: _____ Location: _____

Station 6 Address: _____ Button Style: _____ Location: _____

Station 7 Address: _____ Button Style: _____ Location: _____

Station 8 Address: _____ Button Style: _____ Location: _____

Station 9 Address: _____ Button Style: _____ Location: _____

Station 10 Address: _____ Button Style: _____ Location: _____

Station 11 Address: _____ Button Style: _____ Location: _____

Station 12 Address: _____ Button Style: _____ Location: _____

Station 13 Address: _____ Button Style: _____ Location: _____

Station 14 Address: _____ Button Style: _____ Location: _____

Station 15 Address: _____ Button Style: _____ Location: _____

Station 16 Address: _____ Button Style: _____ Location: _____

Section 7 • APPENDIX H

Station Macros

Station Address: _____

Button 1 - Press/Release macro

1: _____	2: _____	3: _____
4: _____	5: _____	6: _____
7: _____	8: _____	9: _____
10: _____	11: _____	12: _____
13: _____	14: _____	15: _____
16: _____	17: _____	18: _____
19: _____	20: _____	21: _____
22: _____	23: _____	24: _____

Button 1 - Press/Hold macro

1: _____	2: _____	3: _____
4: _____	5: _____	6: _____
7: _____	8: _____	9: _____
10: _____	11: _____	12: _____
13: _____	14: _____	15: _____
16: _____	17: _____	18: _____
19: _____	20: _____	21: _____
22: _____	23: _____	24: _____

Button 2 - Press/Release macro

1: _____	2: _____	3: _____
4: _____	5: _____	6: _____
7: _____	8: _____	9: _____
10: _____	11: _____	12: _____
13: _____	14: _____	15: _____
16: _____	17: _____	18: _____
19: _____	20: _____	21: _____
22: _____	23: _____	24: _____

Button 2 - Press/Hold macro

1: _____	2: _____	3: _____
4: _____	5: _____	6: _____
7: _____	8: _____	9: _____
10: _____	11: _____	12: _____
13: _____	14: _____	15: _____
16: _____	17: _____	18: _____
19: _____	20: _____	21: _____
22: _____	23: _____	24: _____

Section 7 • APPENDIX H

Button 3 - Press/Release macro

1: _____	2: _____	3: _____
4: _____	5: _____	6: _____
7: _____	8: _____	9: _____
10: _____	11: _____	12: _____
13: _____	14: _____	15: _____
16: _____	17: _____	18: _____
19: _____	20: _____	21: _____
22: _____	23: _____	24: _____

Button 3 - Press/Hold macro

1: _____	2: _____	3: _____
4: _____	5: _____	6: _____
7: _____	8: _____	9: _____
10: _____	11: _____	12: _____
13: _____	14: _____	15: _____
16: _____	17: _____	18: _____
19: _____	20: _____	21: _____
22: _____	23: _____	24: _____

Button 4 - Press/Release macro

1: _____	2: _____	3: _____
4: _____	5: _____	6: _____
7: _____	8: _____	9: _____
10: _____	11: _____	12: _____
13: _____	14: _____	15: _____
16: _____	17: _____	18: _____
19: _____	20: _____	21: _____
22: _____	23: _____	24: _____

Button 4 - Press/Hold macro

1: _____	2: _____	3: _____
4: _____	5: _____	6: _____
7: _____	8: _____	9: _____
10: _____	11: _____	12: _____
13: _____	14: _____	15: _____
16: _____	17: _____	18: _____
19: _____	20: _____	21: _____
22: _____	23: _____	24: _____

Section 7 • APPENDIX H

Button 5 - Press/Release macro

1: _____	2: _____	3: _____
4: _____	5: _____	6: _____
7: _____	8: _____	9: _____
10: _____	11: _____	12: _____
13: _____	14: _____	15: _____
16: _____	17: _____	18: _____
19: _____	20: _____	21: _____
22: _____	23: _____	24: _____

Button 5 - Press/Hold macro

1: _____	2: _____	3: _____
4: _____	5: _____	6: _____
7: _____	8: _____	9: _____
10: _____	11: _____	12: _____
13: _____	14: _____	15: _____
16: _____	17: _____	18: _____
19: _____	20: _____	21: _____
22: _____	23: _____	24: _____

Button 6 - Press/Release macro

1: _____	2: _____	3: _____
4: _____	5: _____	6: _____
7: _____	8: _____	9: _____
10: _____	11: _____	12: _____
13: _____	14: _____	15: _____
16: _____	17: _____	18: _____
19: _____	20: _____	21: _____
22: _____	23: _____	24: _____

Button 6 - Press/Hold macro

1: _____	2: _____	3: _____
4: _____	5: _____	6: _____
7: _____	8: _____	9: _____
10: _____	11: _____	12: _____
13: _____	14: _____	15: _____
16: _____	17: _____	18: _____
19: _____	20: _____	21: _____
22: _____	23: _____	24: _____

Section 7 • APPENDIX H

Button 7 - Press/Release macro

1: _____	2: _____	3: _____
4: _____	5: _____	6: _____
7: _____	8: _____	9: _____
10: _____	11: _____	12: _____
13: _____	14: _____	15: _____
16: _____	17: _____	18: _____
19: _____	20: _____	21: _____
22: _____	23: _____	24: _____

Button 7 - Press/Hold macro

1: _____	2: _____	3: _____
4: _____	5: _____	6: _____
7: _____	8: _____	9: _____
10: _____	11: _____	12: _____
13: _____	14: _____	15: _____
16: _____	17: _____	18: _____
19: _____	20: _____	21: _____
22: _____	23: _____	24: _____

Button 8 - Press/Release macro

1: _____	2: _____	3: _____
4: _____	5: _____	6: _____
7: _____	8: _____	9: _____
10: _____	11: _____	12: _____
13: _____	14: _____	15: _____
16: _____	17: _____	18: _____
19: _____	20: _____	21: _____
22: _____	23: _____	24: _____

Button 8 - Press/Hold macro

1: _____	2: _____	3: _____
4: _____	5: _____	6: _____
7: _____	8: _____	9: _____
10: _____	11: _____	12: _____
13: _____	14: _____	15: _____
16: _____	17: _____	18: _____
19: _____	20: _____	21: _____
22: _____	23: _____	24: _____

Section 7 • APPENDIX H

Button 9 - Press/Release macro

1: _____	2: _____	3: _____
4: _____	5: _____	6: _____
7: _____	8: _____	9: _____
10: _____	11: _____	12: _____
13: _____	14: _____	15: _____
16: _____	17: _____	18: _____
19: _____	20: _____	21: _____
22: _____	23: _____	24: _____

Button 9 - Press/Hold macro

1: _____	2: _____	3: _____
4: _____	5: _____	6: _____
7: _____	8: _____	9: _____
10: _____	11: _____	12: _____
13: _____	14: _____	15: _____
16: _____	17: _____	18: _____
19: _____	20: _____	21: _____
22: _____	23: _____	24: _____

Macro Elements

Zone Control

Zone 1, Vol Up	Volume up macro element for Zone 1. This macro element uses both the press/release and press/hold features of the station button.
Zone 1, Vol Dwn	Volume down macro element for Zone 1. This macro element uses both the press/release and press/hold features of the station button.
Zone 1, Mute	Sets Zone 1 to the mute volume level, which is installer adjustable.
Zone 1, Unmute	Unmutes Zone 1, setting the volume level to either the last volume level the zone was at, or to the default volume level, based on the installer settable options. More information on the mute options is available in the System Configuration section of the manual, located under the Configuring Zones subchapter.
Zone 1, Treble Up	Treble tone control, increases treble level for zone 1 - stereo mode only. This macro element uses both the press/release and press/hold features of the station button.
Zone 1, Treble Dwn	Treble tone control, decreases treble level for zone 1 - stereo mode only. This macro element uses both the press/release and press/hold features of the station button.
Zone 1, Bass Up	Bass tone control, increases bass level for zone 1 - stereo mode only. This macro element uses both the press/release and press/hold features of the station button.
Zone 1, Bass Dwn	Bass tone control, decreases bass level for zone 1 - stereo mode only. This macro element uses both the press/release and press/hold features of the station button.
Zone 1L, Vol Up	Volume up macro element for Zone 1, left side - Used in split zone mode. This macro element uses both the press/release and press/hold features of the station button.
Zone 1R, Vol Up	Volume up macro element for Zone 1, right side - Used in split zone mode. This macro element uses both the press/release and press/hold features of the station button.
Zone 1L, Vol Dwn	Volume down macro element for Zone 1, left side - Used in split zone mode. This macro element uses both the press/release and press/hold features of the station button.
Zone 1R, Vol Dwn	Volume down macro element for Zone 1, right side - Used in split zone mode. This macro element uses both the press/release and press/hold features of the station button.
Zone 1L, Mute	Sets Zone 1, left side to the mute volume level, which is installer adjustable.
Zone 1R, Mute	Sets Zone 1, right side to the mute volume level, which is installer adjustable.
Zone 1L, Unmute	Unmutes Zone 1, left side, setting the volume level to either the last volume level the zone was at, or to the default volume level.
Zone 1R, Unmute	Unmutes Zone 1, right side, setting the volume level to either the last volume level the zone was at, or to the default volume level.

Zone 2, Vol Up	Volume up macro element for Zone 2. This macro element uses both the press/release and press/hold features of the station button.
Zone 2, Vol Dwn	Volume down macro element for Zone 2. This macro element uses both the press/release and press/hold features of the station button.
Zone 2, Mute	Sets Zone 2 to the mute volume level, which is installer adjustable.
Zone 2, Unmute	Unmutes Zone 2, setting the volume level to either the last volume level the zone was at, or to the default volume level, based on the installer settable options. More information on the mute options is available in the System Configuration section of the manual, located under the Configuring Zones subchapter.
Zone 2, Treble Up	Treble tone control, increases treble level for zone 2 - stereo mode only. This macro element uses both the press/release and press/hold features of the station button.
Zone 2, Treble Dwn	Treble tone control, decreases treble level for zone 2 - stereo mode only. This macro element uses both the press/release and press/hold features of the station button.
Zone 2, Bass Up	Bass tone control, increases bass level for zone 2 - stereo mode only. This macro element uses both the press/release and press/hold features of the station button.
Zone 2, Bass Dwn	Bass tone control, decreases bass level for zone 2 - stereo mode only. This macro element uses both the press/release and press/hold features of the station button.
Zone 2L, Vol Up	Volume up macro element for Zone 2, left side - Used in split zone mode. This macro element uses both the press/release and press/hold features of the station button.
Zone 2R, Vol Up	Volume up macro element for Zone 2, right side - Used in split zone mode. This macro element uses both the press/release and press/hold features of the station button.
Zone 2L, Vol Dwn	Volume down macro element for Zone 2, left side - Used in split zone mode. This macro element uses both the press/release and press/hold features of the station button.
Zone 2R, Vol Dwn	Volume down macro element for Zone 2, right side - Used in split zone mode. This macro element uses both the press/release and press/hold features of the station button.
Zone 2L, Mute	Sets Zone 2, left side to the mute volume level, which is installer adjustable.
Zone 2R, Mute	Sets Zone 2, right side to the mute volume level, which is installer adjustable.
Zone 2L, Unmute	Unmutes Zone 2, left side, setting the volume level to either the last volume level the zone was at, or to the default volume level.
Zone 2R, Unmute	Unmutes Zone 2, right side, setting the volume level to either the last volume level the zone was at, or to the default volume level.
Zone 3, Vol Up	Volume up macro element for Zone 3. This macro element uses both the press/release and press/hold features of the station button.

Zone 3, Vol Dwn	Volume down macro element for Zone 3. This macro element uses both the press/release and press/hold features of the station button.
Zone 3, Mute	Sets Zone 3 to the mute volume level, which is installer adjustable.
Zone 3, Unmute	Unmutes Zone 3, setting the volume level to either the last volume level the zone was at, or to the default volume level, based on the installer settable options. More information on the mute options is available in the System Configuration section of the manual, located under the Configuring Zones subchapter.
Zone 3, Treble Up	Treble tone control, increases treble level for zone 3 - stereo mode only. This macro element uses both the press/release and press/hold features of the station button.
Zone 3, Treble Dwn	Treble tone control, decreases treble level for zone 3 - stereo mode only. This macro element uses both the press/release and press/hold features of the station button.
Zone 3, Bass Up	Bass tone control, increases bass level for zone 3 - stereo mode only. This macro element uses both the press/release and press/hold features of the station button.
Zone 3, Bass Dwn	Bass tone control, decreases bass level for zone 3 - stereo mode only. This macro element uses both the press/release and press/hold features of the station button.
Zone 3L, Vol Up	Volume up macro element for Zone 3, left side - Used in split zone mode. This macro element uses both the press/release and press/hold features of the station button.
Zone 3R, Vol Up	Volume up macro element for Zone 3, right side - Used in split zone mode. This macro element uses both the press/release and press/hold features of the station button.
Zone 3L, Vol Dwn	Volume down macro element for Zone 3, left side - Used in split zone mode. This macro element uses both the press/release and press/hold features of the station button.
Zone 3R, Vol Dwn	Volume down macro element for Zone 3, right side - Used in split zone mode. This macro element uses both the press/release and press/hold features of the station button.
Zone 3L, Mute	Sets Zone 3, left side to the mute volume level, which is installer adjustable.
Zone 3R, Mute	Sets Zone 3, right side to the mute volume level, which is installer adjustable.
Zone 3L, Unmute	Unmutes Zone 3, left side, setting the volume level to either the last volume level the zone was at, or to the default volume level.
Zone 3R, Unmute	Unmutes Zone 3, right side, setting the volume level to either the last volume level the zone was at, or to the default volume level.
Zone 4, Vol Up	Volume up macro element for Zone 4. This macro element uses both the press/release and press/hold features of the station button.
Zone 4, Vol Dwn	Volume down macro element for Zone 4. This macro element uses both the press/release and press/hold features of the station button.

Zone 4, Mute	Sets Zone 4 to the mute volume level, which is installer adjustable.
Zone 4, Unmute	Unmutes Zone 4, setting the volume level to either the last volume level the zone was at, or to the default volume level, based on the installer settable options. More information on the mute options is available in the System Configuration section of the manual, located under the Configuring Zones subchapter.
Zone 4, Treble Up	Treble tone control, increases treble level for zone 4 - stereo mode only. This macro element uses both the press/release and press/hold features of the station button.
Zone 4, Treble Dwn	Treble tone control, decreases treble level for zone 4 - stereo mode only. This macro element uses both the press/release and press/hold features of the station button.
Zone 4, Bass Up	Bass tone control, increases bass level for zone 4 - stereo mode only. This macro element uses both the press/release and press/hold features of the station button.
Zone 4, Bass Dwn	Bass tone control, decreases bass level for zone 4 - stereo mode only. This macro element uses both the press/release and press/hold features of the station button.
Zone 4L, Vol Up	Volume up macro element for Zone 4, left side - Used in split zone mode. This macro element uses both the press/release and press/hold features of the station button.
Zone 4R, Vol Up	Volume up macro element for Zone 4, right side - Used in split zone mode. This macro element uses both the press/release and press/hold features of the station button.
Zone 4L, Vol Dwn	Volume down macro element for Zone 4, left side - Used in split zone mode. This macro element uses both the press/release and press/hold features of the station button.
Zone 4R, Vol Dwn	Volume down macro element for Zone 4, right side - Used in split zone mode. This macro element uses both the press/release and press/hold features of the station button.
Zone 4L, Mute	Sets Zone 4, left side to the mute volume level, which is installer adjustable.
Zone 4R, Mute	Sets Zone 4, right side to the mute volume level, which is installer adjustable.
Zone 4L, Unmute	Unmutes Zone 4, left side, setting the volume level to either the last volume level the zone was at, or to the default volume level.
Zone 4R, Unmute	Unmutes Zone 4, right side, setting the volume level to either the last volume level the zone was at, or to the default volume level.
Zone 5, Vol Up	Volume up macro element for Zone 5. This macro element uses both the press/release and press/hold features of the station button.
Zone 5, Vol Dwn	Volume down macro element for Zone 5. This macro element uses both the press/release and press/hold features of the station button.
Zone 5, Mute	Sets Zone 5 to the mute volume level, which is installer adjustable.

Zone 5, Unmute	Unmutes Zone 5, setting the volume level to either the last volume level the zone was at, or to the default volume level, based on the installer settable options. More information on the mute options is available in the System Configuration section of the manual, located under the Configuring Zones subchapter.
Zone 5, Treble Up	Treble tone control, increases treble level for zone 5 - stereo mode only. This macro element uses both the press/release and press/hold features of the station button.
Zone 5, Treble Dwn	Treble tone control, decreases treble level for zone 5 - stereo mode only. This macro element uses both the press/release and press/hold features of the station button.
Zone 5, Bass Up	Bass tone control, increases bass level for zone 5 - stereo mode only. This macro element uses both the press/release and press/hold features of the station button.
Zone 5, Bass Dwn	Bass tone control, decreases bass level for zone 5 - stereo mode only. This macro element uses both the press/release and press/hold features of the station button.
Zone 5L, Vol Up	Volume up macro element for Zone 5, left side - Used in split zone mode. This macro element uses both the press/release and press/hold features of the station button.
Zone 5R, Vol Up	Volume up macro element for Zone 5, right side - Used in split zone mode. This macro element uses both the press/release and press/hold features of the station button.
Zone 5L, Vol Dwn	Volume down macro element for Zone 5, left side - Used in split zone mode. This macro element uses both the press/release and press/hold features of the station button.
Zone 5R, Vol Dwn	Volume down macro element for Zone 5, right side - Used in split zone mode. This macro element uses both the press/release and press/hold features of the station button.
Zone 5L, Mute	Sets Zone 5, left side to the mute volume level, which is installer adjustable.
Zone 5R, Mute	Sets Zone 5, right side to the mute volume level, which is installer adjustable.
Zone 5L, Unmute	Unmutes Zone 5, left side, setting the volume level to either the last volume level the zone was at, or to the default volume level.
Zone 5R, Unmute	Unmutes Zone 5, right side, setting the volume level to either the last volume level the zone was at, or to the default volume level.
Zone 6, Vol Up	Volume up macro element for Zone 6. This macro element uses both the press/release and press/hold features of the station button.
Zone 6, Vol Dwn	Volume down macro element for Zone 6. This macro element uses both the press/release and press/hold features of the station button.
Zone 6, Mute	Sets Zone 6 to the mute volume level, which is installer adjustable.

Zone 6, Unmute	Unmutes Zone 6, setting the volume level to either the last volume level the zone was at, or to the default volume level, based on the installer settable options. More information on the mute options is available in the System Configuration section of the manual, located under the Configuring Zones subchapter.
Zone 6, Treble Up	Treble tone control, increases treble level for zone 6 - stereo mode only. This macro element uses both the press/release and press/hold features of the station button.
Zone 6, Treble Dwn	Treble tone control, decreases treble level for zone 6 - stereo mode only. This macro element uses both the press/release and press/hold features of the station button.
Zone 6, Bass Up	Bass tone control, increases bass level for zone 6 - stereo mode only. This macro element uses both the press/release and press/hold features of the station button.
Zone 6, Bass Dwn	Bass tone control, decreases bass level for zone 6 - stereo mode only. This macro element uses both the press/release and press/hold features of the station button.
Zone 6L, Vol Up	Volume up macro element for Zone 6, left side - Used in split zone mode. This macro element uses both the press/release and press/hold features of the station button.
Zone 6R, Vol Up	Volume up macro element for Zone 6, right side - Used in split zone mode. This macro element uses both the press/release and press/hold features of the station button.
Zone 6L, Vol Dwn	Volume down macro element for Zone 6, left side - Used in split zone mode. This macro element uses both the press/release and press/hold features of the station button.
Zone 6R, Vol Dwn	Volume down macro element for Zone 6, right side - Used in split zone mode. This macro element uses both the press/release and press/hold features of the station button.
Zone 6L, Mute	Sets Zone 6, left side to the mute volume level, which is installer adjustable.
Zone 6R, Mute	Sets Zone 6, right side to the mute volume level, which is installer adjustable.
Zone 6L, Unmute	Unmutes Zone 6, left side, setting the volume level to either the last volume level the zone was at, or to the default volume level.
Zone 6R, Unmute	Unmutes Zone 6, right side, setting the volume level to either the last volume level the zone was at, or to the default volume level.
Unmute	Generic unmute command. This macro element unmutes all zones that had sources assigned to them by other macro elements in this macro, only. Each zone that is unmuted is set to either the last volume level the zone was at, or to the default volume level, depending on how the mute behavior was configured for that zone. This macro element was added to free up macro steps that would otherwise be used up when it was necessary to unmute multiple zones in one macro. The Unmute element must appear after all of the source selection elements in a macro, however it may be placed before any other macro elements if so desired.

Mute All	Mutes all zones. This macro element can be used to implement a system wide mute macro feature.
Unmute All	Unconditionally unmutes all zones, setting the volume level in each zone to either the default volume level for that zone or to the last volume level that was set for the zone, depending on how that zone was configured.

Source Selection

Zone 1, Src 1	Select source 1 for zone 1.
Zone 1, Src 2	Select source 2 for zone 1.
Zone 1, Src 3	Select source 3 for zone 1.
Zone 1, Src 4	Select source 4 for zone 1.
Zone 2, Src 1	Select source 1 for zone 2.
Zone 2, Src 2	Select source 2 for zone 2.
Zone 2, Src 3	Select source 3 for zone 2.
Zone 2, Src 4	Select source 4 for zone 2.
Zone 3, Src 1	Select source 1 for zone 3.
Zone 3, Src 2	Select source 2 for zone 3.
Zone 3, Src 3	Select source 3 for zone 3.
Zone 3, Src 4	Select source 4 for zone 3.
Zone 4, Src 1	Select source 1 for zone 4.
Zone 4, Src 2	Select source 2 for zone 4.
Zone 4, Src 3	Select source 3 for zone 4.
Zone 4, Src 4	Select source 4 for zone 4.
Zone 5, Src 1	Select source 1 for zone 5.
Zone 5, Src 2	Select source 2 for zone 5.
Zone 5, Src 3	Select source 3 for zone 5.
Zone 5, Src 4	Select source 4 for zone 5.

Zone 6, Src 1	Select source 1 for zone 6.
Zone 6, Src 2	Select source 2 for zone 6.
Zone 6, Src 3	Select source 3 for zone 6.
Zone 6, Src 4	Select source 4 for zone 6.

Source Control

The Source Control macro elements send machine control commands to the sources. Each machine control command has a delay time that can be set by the installer, which is used to give feedback to the homeowner by way of the status leds on the wall stations.

Src 1, Cntl 1	Send source 1's machine control command #1 to source 1.
Src 1, Cntl 2	Send source 1's machine control command #2 to source 1.
Src 1, Cntl 3	Send source 1's machine control command #3 to source 1.
Src 1, Cntl 4	Send source 1's machine control command #4 to source 1.
Src 1, Cntl 5	Send source 1's machine control command #5 to source 1.
Src 1, Cntl 6	Send source 1's machine control command #6 to source 1.
Src 1, Cntl 7	Send source 1's machine control command #7 to source 1.
Src 1, Cntl 8	Send source 1's machine control command #8 to source 1.
Src 1, Cntl 9	Send source 1's machine control command #9 to source 1.
Src 1, Cntl 10	Send source 1's machine control command #10 to source 1.
Src 1, Cntl 11	Send source 1's machine control command #11 to source 1.
Src 1, Cntl 12	Send source 1's machine control command #12 to source 1.
Src 1, Cntl 13	Send source 1's machine control command #13 to source 1.
Src 1, Cntl 14	Send source 1's machine control command #14 to source 1.
Src 1, Cntl 15	Send source 1's machine control command #15 to source 1.
Src 1, Cntl 16	Send source 1's machine control command #16 to source 1.

Src 2, Cntl 1	Send source 2's machine control command #1 to source 2.
Src 2, Cntl 2	Send source 2's machine control command #2 to source 2.
Src 2, Cntl 3	Send source 2's machine control command #3 to source 2.
Src 2, Cntl 4	Send source 2's machine control command #4 to source 2.
Src 2, Cntl 5	Send source 2's machine control command #5 to source 2.
Src 2, Cntl 6	Send source 2's machine control command #6 to source 2.
Src 2, Cntl 7	Send source 2's machine control command #7 to source 2.
Src 2, Cntl 8	Send source 2's machine control command #8 to source 2.
Src 2, Cntl 9	Send source 2's machine control command #9 to source 2.
Src 2, Cntl 10	Send source 2's machine control command #10 to source 2.
Src 2, Cntl 11	Send source 2's machine control command #11 to source 2.
Src 2, Cntl 12	Send source 2's machine control command #12 to source 2.
Src 2, Cntl 13	Send source 2's machine control command #13 to source 2.
Src 2, Cntl 14	Send source 2's machine control command #14 to source 2.
Src 2, Cntl 15	Send source 2's machine control command #15 to source 2.
Src 2, Cntl 16	Send source 2's machine control command #16 to source 2.
Src 3, Cntl 1	Send source 3's machine control command #1 to source 3.
Src 3, Cntl 2	Send source 3's machine control command #2 to source 3.
Src 3, Cntl 3	Send source 3's machine control command #3 to source 3.
Src 3, Cntl 4	Send source 3's machine control command #4 to source 3.
Src 3, Cntl 5	Send source 3's machine control command #5 to source 3.
Src 3, Cntl 6	Send source 3's machine control command #6 to source 3.
Src 3, Cntl 7	Send source 3's machine control command #7 to source 3.
Src 3, Cntl 8	Send source 3's machine control command #8 to source 3.
Src 3, Cntl 9	Send source 3's machine control command #9 to source 3.
Src 3, Cntl 10	Send source 3's machine control command #10 to source 3.
Src 3, Cntl 11	Send source 3's machine control command #11 to source 3.
Src 3, Cntl 12	Send source 3's machine control command #12 to source 3.
Src 3, Cntl 13	Send source 3's machine control command #13 to source 3.

Section 7 • APPENDIX I

Src 3, Cntl 14	Send source 3's machine control command #14 to source 3.
Src 3, Cntl 15	Send source 3's machine control command #15 to source 3.
Src 3, Cntl 16	Send source 3's machine control command #16 to source 3.
Src 4, Cntl 1	Send source 4's machine control command #1 to source 4.
Src 4, Cntl 2	Send source 4's machine control command #2 to source 4.
Src 4, Cntl 3	Send source 4's machine control command #3 to source 4.
Src 4, Cntl 4	Send source 4's machine control command #4 to source 4.
Src 4, Cntl 5	Send source 4's machine control command #5 to source 4.
Src 4, Cntl 6	Send source 4's machine control command #6 to source 4.
Src 4, Cntl 7	Send source 4's machine control command #7 to source 4.
Src 4, Cntl 8	Send source 4's machine control command #8 to source 4.
Src 4, Cntl 9	Send source 4's machine control command #9 to source 4.
Src 4, Cntl 10	Send source 4's machine control command #10 to source 4.
Src 4, Cntl 11	Send source 4's machine control command #11 to source 4.
Src 4, Cntl 12	Send source 4's machine control command #12 to source 4.
Src 4, Cntl 13	Send source 4's machine control command #13 to source 4.
Src 4, Cntl 14	Send source 4's machine control command #14 to source 4.
Src 4, Cntl 15	Send source 4's machine control command #15 to source 4.
Src 4, Cntl 16	Send source 4's machine control command #16 to source 4.

Conditional Statements

If Zone 1 Cur Src Then

If Zone 2 Cur Src Then

If Zone 3 Cur Src Then

If Zone 4 Cur Src Then

If Zone 5 Cur Src Then

If Zone 6 Cur Src Then

Conditional macro element that sends a machine control command for a source based on the source currently selected in that zone. Any number of machine commands for a given source may be specified, within the limits of the number of elements in a macro.

These elements are used before all of the machine commands on the button. If there are multiple zones that would be affected by the execution of a machine command for a given source, then multiple If Zx Cur Src Then (one for each zone involved) macro elements may be used together, and must appear before all of the machine commands on the button.

Power Control

Power On	Turns on power for the whole system. The delay between when power has been applied to the sources and when power is applied to the amplifiers is settable by the installer. Additionally, during the delay time, the status led on the wall station that corresponds to the button that the homeowner pressed will blink until the delay has expired.
Power Off	Turns all power off to the sources and amplifiers.
Srcs On	Turns on power to the source outlet only.
Srcs Off	Turns off power to the source outlet only.
Amp On	Turns on power to the amplifier outlet only.
Amp Off	Turns off power to the amplifier outlet only.

Miscellaneous

Mutually Exclusive	This element is used to control the behavior of the led associated with a button. When a number of buttons on a station have been programmed such that only one of a group of buttons is active at a time, such as a group of radio station presets on a tuner or disc select buttons for a CD player, it is necessary to have a way of indicating which preset was the last one that was selected. By using the Mutually Exclusive macro element at the end of the machine commands for a source, the led status for that button will be determined by matching the last machine command that was sent to the source with the commands that are part of the macro on the button. If the last command that was sent to the source matches one of the commands assigned to the button, the LED is on, otherwise it is off.
Led On	Turns the led on a button on.
Led Off	Turns the led on a button off.

External control commands

The Director Model 46 can be controlled by another computer system by a simple set of commands which represent wall station button presses. This allows the external computer to control The Director Model 46 as though it had stations attached to the station network. For each station address and button, there must be a valid macro programmed, just as if it was a standard wall station. The only restriction on this is that the total number of stations is still 16.

For the purposes of the descriptions below of the various aspects of the messages that may be sent to the Director, the following conventions apply:

ASCII text messages are enclosed in quotes, although the quotes are not actually transmitted by the Director.

All ASCII values shown are given in decimal unless otherwise indicated.

The <cr> symbol means carriage return or enter. Equivalent to ASCII 13.

There are four types of messages that may be sent to the Director. They are:

1) Button Press/Release message: This message represents the pressing and releasing of a station button, and results in the execution of the press/release macro that has been programmed on that button.

The message format is:

S02B1<cr>

Where 'S02' represents the station address (station 02 in this case), 'B1' represents button 1 on the selected station, and <cr> represents a carriage return, ASCII 13 as a command terminator. Valid button numbers are 1 to 9. The Director returns the text string "OK<cr>" upon completion of the press/release macro programmed on that button. If there is an error in the command message sent to The Director it will respond with the ASCII text string "ERROR<cr>".

2) Button Press and Hold message: This message represents the pressing and holding of a station button, and results in the execution of the press/hold macro that has been programmed on that button.

The message format is:

S02B1P<cr>

Where 'S02' represents the station address (station 02 in this case), 'B1' represents button 1 on the selected station, 'P' represents the Press of the button, and <cr> represents a carriage return, ASCII 13. Valid button numbers are 1 to 9. The Director returns the text string "OK<cr>" upon completion of the press macro programmed on that button. If there is an error in the command message sent to The Director it will respond with the ASCII text string "ERROR<cr>". If this is a volume up or volume down macro, the Director will only return the "OK<cr>" message after the volume message timer expires. If the volume message timer expires, the button press volume macro will be terminated, and it is not necessary to send the corresponding button release message if the "OK<cr>" reply has been received.

3) Button Release message: This message is the complement to the above Button Press message, and is used to notify the Director that the previously pressed button is being released, ending the press/hold macro, if the macro is waiting for the release of the button (volume up and down commands).

IMPORTANT

NOTE: When the button that is being pressed has been programmed with a volume up or volume down macro, this message must be repeated at a minimum of 500mS intervals to refresh the internal volume message timer. The timer assures that a failure to receive the button release message for the current button does not cause The Director to continue to raise (or lower) the volume level past the desired point.

The message format is:

```
S02B1R<cr>
```

Where 'S02' represents the station address (station 02 in this case), 'B1' represents button 1 on the selected station, R represents the Release of the button, and <cr> represents a carriage return, ASCII 13. Valid button numbers are 1 to 9. The Director returns the text string "OK<cr>" upon completion of the release of the station button. If there is an error in the command message sent to The Director it will respond with the ASCII text string "ERROR<cr>".

4) Station Status query message: This message is used to poll the Director to get the LED status for a station. The Director responds to the status query with a string of '1's and '0's representing the ON ('1') and OFF ('0') state of each led on the station.

The message format is:

```
S02B?<cr>
```

Where 'S02' represents the station address (station 02 in this case), 'B?' represents the request for status, and <cr> represents a carriage return, ASCII 13. The Director will respond with the following string:

```
10000001<cr>
```

```
OK<cr>
```

In the above example, the leds for buttons 1 and 9 are ON, the rest of the leds on the station are off. The response from the Director is terminated by a carriage return <cr>. After the successful completion of the status query message, the Director returns the text string "OK<cr>". If there is an error in the command message sent to the Director, then the Director will reply with the text string "ERROR<cr>".

Front Panel Drawings

NOTES:

ALL DIMENSIONS IN INCHES.
 TOLERANCE: $\pm .010$
 MATERIAL: .125 STEEL
 ALL EDGES AND HOLES DEBURRED
 ALL CORNERS BROKEN
 FINISH AS PER AUDIOCONTROL
 PAINTING PROCEDURES.

DO NOT SCALE DRAWING

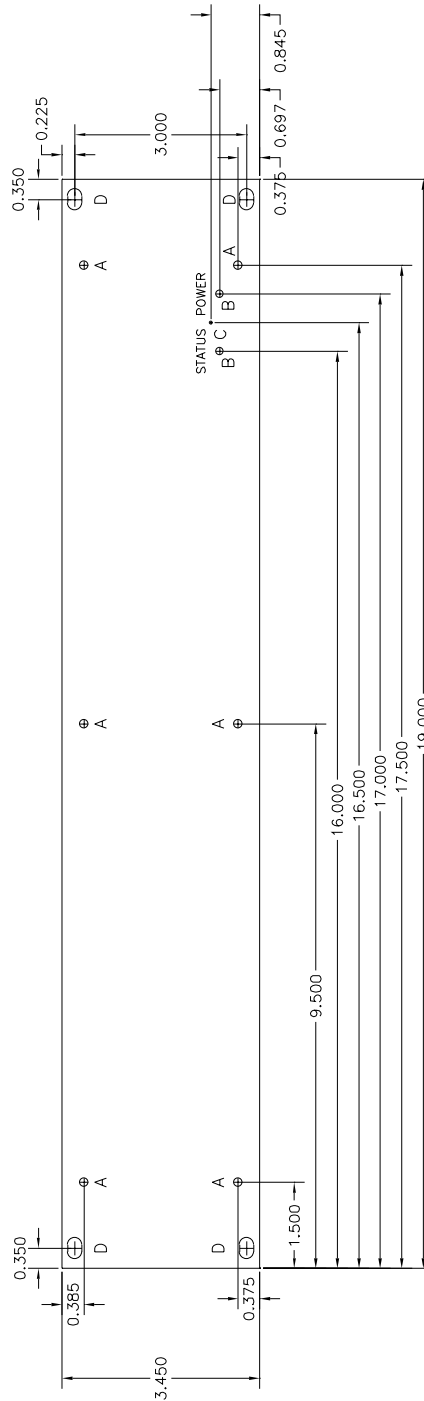

HOLE DETAILS

- 'A' - .147 DIA
 - 'B' - .128 DIA
 - 'C' - .050 DIA
 - 'D' DETAIL
-
- 0.370
R0.125
0.250

NOTES:
 ALL DIMENSIONS IN INCHES.
 TOLERANCE: $\pm .010$
 MATERIAL: .125 STEEL
 ALL EDGES AND HOLES DEBURRED
 ALL CORNERS BROKEN
 FINISH AS PER AUDIOCONTROL
 PAINTING PROCEDURES.
 DO NOT SCALE DRAWING

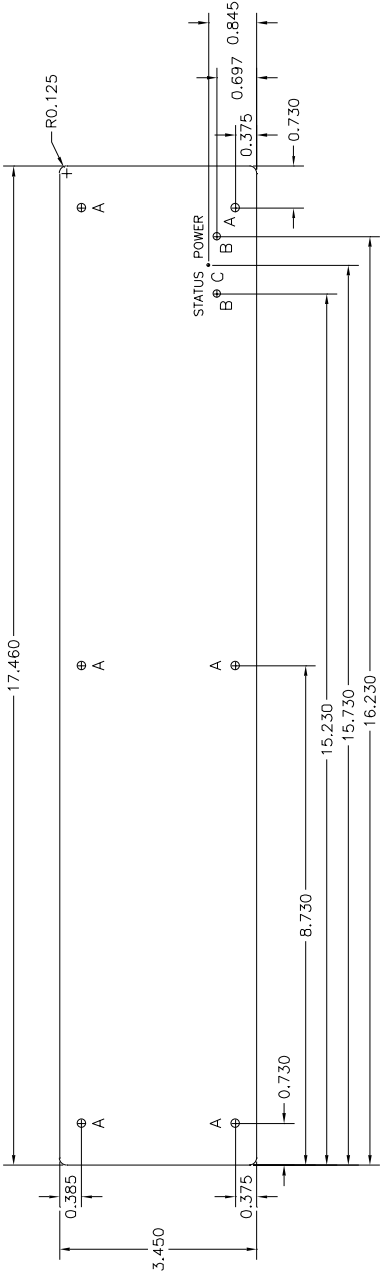

HOLE DETAILS
 'A' - .147 DIA
 'B' - .128 DIA
 'C' - .050 DIA

Factory Default Programming

Stations 1 and 2

Zone 1

D46 CONFIGURATION DATA / ZONE 1

DISC 1	A1	DISC 2	A2	MARANTZ FM [S1] FM-1	B1	NEXT [HOLD=NXT CD]	B2	
DISC 3	A3	DISC 4	A4	MARANTZ FM [S2] FM-2	B3	LAST [HOLD=PAUSE]	B4	
DISC 5	A5	CD SHUFFLE [HOLD=UNSHUFFLE]	A6	SONY 5-DISC CD [S3] CD-1	B5	VOL UP	B6	
FM PSET-1	A7	FM PSET-2	A8	SONY 5-DISC CD [S4] CD-2 [HOLD=STOP/CLEAR]	B7	VOL DN	B8	
SYS OFF				A9	MUTE (/OFF) [HOLD=OFF]			B9
CS# 1				CS# 2				

PUSH / RELEASE FUNCTIONS

A1	DISC 1	IF Z1, IF Z2, S3 C14, S3 C13, S3 C8, ME, S4 C14, S4 C13, S4 C8, ME
A2	DISC 2	IF Z1, IF Z2, S3 C14, S3 C13, S3 C9, ME, S4 C14, S4 C13, S4 C9, ME
A3	DISC 3	IF Z1, IF Z2, S3 C14, S3 C13, S3 C10, ME, S4 C14, S4 C13, S4 C10, ME
A4	DISC 4	IF Z1, IF Z2, S3 C14, S3 C13, S3 C11, ME, S4 C14, S4 C13, S4 C11, ME
A5	DISC 5	IF Z1, IF Z2, S3 C14, S3 C13, S3 C12, ME, S4 C14, S4 C13, S4 C12, ME
A6	CD SHUFFLE	IF Z1, IF Z2, S3 C14, S3 C6, S3 C1, S4 C14, S4 C6, S4 C1
A7	FM PSET-1	IF Z1, IF Z2, S1 C3, ME, S2 C3, ME
A8	FM PSET-2	IF Z1, IF Z2, S1 C4, ME, S2 C4, ME
A9	SYS OFF	SYSTEM OFF
B1	FM-1	SYSTEM ON, Z1 S1, Z2 S1, Z1 UNMUTE
B2	NEXT	IF Z1, IF Z2, S1 C1, S2 C1, S3 C3, S4 C3
B3	FM-2	SYSTEM ON, Z1 S2, Z2 S2, Z1 UNMUTE
B4	LAST	IF Z1, IF Z2, S1 C2, S2 C2, S3 C5, S4 C5
B5	CD-1	SYSTEM ON, Z1 S3, Z2 S3, S3 C1, Z1 UNMUTE
B6	VOL UP	ZONE 1, VOLUME UP
B7	CD-2	SYSTEM ON, Z1 S4, Z2 S4, S4 C1, Z1 UNMUTE
B8	VOL DN	ZONE 1, VOLUME DOWN
B9	MUTE	ZONE 1, MUTE / UNMUTE

<u>SOURCE</u>	<u>#</u>	<u>COMMAND</u>
FM 1 OR 2	1	PSET-UP
FM 1 OR 2	2	PSET-DN
FM 1 OR 2	3	PSET 1
FM 1 OR 2	4	PSET 2
CD 1 OR 2	1	PLAY
CD 1 OR 2	2	PAUSE
CD 1 OR 2	3	NXT TRACK
CD 1 OR 2	4	NXT DISC
CD 1 OR 2	5	LAST TRACK
CD 1 OR 2	6	SHUFFLE
CD 1 OR 2	7	STOP
CD 1 OR 2	8	DISC 1
CD 1 OR 2	9	DISC 2
CD 1 OR 2	10	DISC 3
CD 1 OR 2	11	DISC 4
CD 1 OR 2	12	DISC 5
CD 1 OR 2	13	CONTINUE
CD 1 OR 2	14	PROGRAM

Stations 1 and 2

Zone 1

PUSH / HOLD FUNCTIONS

A1	DISC 1	
A2	DISC 2	
A3	DISC 3	
A4	DISC 4	
A5	DISC 5	
A6	CD SHUFFLE	IF Z1, IF Z2, S3 C14, S3 C13, S3 C1, S4 C14, S4 C13, S4 C1
A7	FM PSET-1	
A8	FM PSET-2	
A9	SYS OFF	SYSTEM OFF
B1	FM-1	
B2	NEXT	IF Z1, IF Z2, S3 C14, S3 C13, S3 C4, S4 C14, S4 C13, S4 C4
B3	FM-2	
B4	LAST	IF Z1, IF Z2, S3 C2, S4 C2
B5	CD-1	IF Z1, IF Z2, S3 C14, S3 C13, S3 C7
B6	VOL UP	ZONE 1, VOLUME UP
B7	CD-2	IF Z1, IF Z2, S4 C14, S4 C13, S4 C7
B8	VOL DN	ZONE 1, VOLUME DOWN
B9	MUTE	SYSTEM OFF

Station 3

Zone 1

D46 CONFIGURATION DATA / ZONE 1

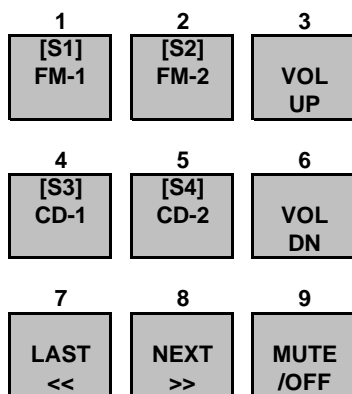

CS# 3

PUSH / RELEASE FUNCTIONS

1	FM-1	SYS ON, Z1 S1, Z2 S1, Z1 UNMUTE
2	FM-2	SYS ON, Z1 S2, Z2 S2, Z1 UNMUTE
3	VOL UP	Z1 VOLUME UP
4	CD-1	SYS ON, Z1 S3, Z2 S3, S3 C1, Z1 UNMUTE
5	CD-2	SYS ON, Z1 S4, Z2 S4, S4 C1, Z1 UNMUTE
6	VOL DN	Z1 VOLUME DOWN
7	LAST	IF Z1, IF Z2, S1 C2, S2 C2, S3 C5, S4 C5
8	NEXT	IF Z1, IF Z2, S1 C1, S2 C1, S3 C3, S4 C3
9	MUTE/OFF	Z1 MUTE/UNMUTE

PUSH / HOLD FUNCTIONS

1	FM 1	
2	FM-2	
3	VOL UP	Z1 VOLUME UP
4	CD-1	IF Z1, IF Z2, S3 C14, S3 C13, S3 C7
5	CD-2	IF Z1, IF Z2, S4 C14, S4 C13, S4 C7
6	VOL DN	Z1 VOLUME DN
7	LAST	IF Z1, IF Z2, S3 C2, S4 C2
8	NEXT	IF Z1, IF Z2, S3 C14, S3 C13, S3 C4, S4 C14, S4 C13, S4 C4
9	MUTE/OFF	SYSTEM OFF

Station 3Zone 1

<u>SOURCE</u>	<u>#</u>	<u>COMMAND</u>
FM 1 OR 2	1	PSET UP
FM 1 OR 2	2	PSET DN
FM 1 OR 2	3	PSET 1
FM 1 OR 2	4	PSET 2
CD 1 OR 2	1	PLAY
CD 1 OR 2	2	PAUSE
CD 1 OR 2	3	NXT TRACK
CD 1 OR 2	4	NXT DISC
CD 1 OR 2	5	LAST TRACK
CD 1 OR 2	6	SHUFFLE (NOT USED)
CD 1 OR 2	7	STOP
CD 1 OR 2	13	CONTINUE
CD 1 OR 2	14	PROGRAM

Stations 4 and 5
Zone 2

D46 CONFIGURATION DATA / ZONE 2

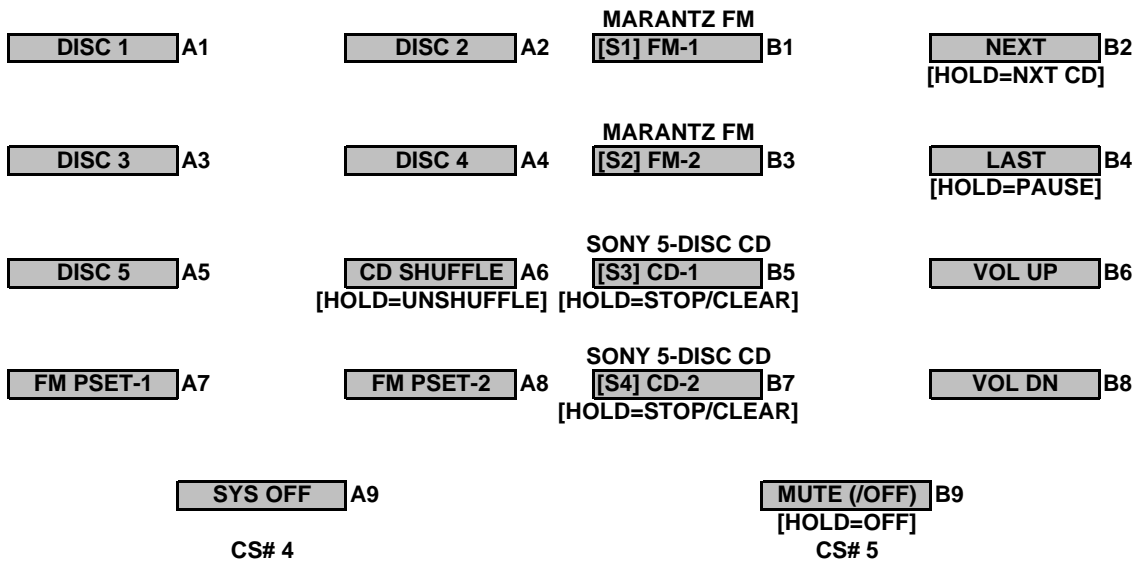

PUSH / RELEASE FUNCTIONS

A1	DISC 1	IF Z1, IF Z2, S3 C14, S3 C13, S3 C8, ME, S4 C14, S4 C13, S4 C8, ME
A2	DISC 2	IF Z1, IF Z2, S3 C14, S3 C13, S3 C9, ME, S4 C14, S4 C13, S4 C9, ME
A3	DISC 3	IF Z1, IF Z2, S3 C14, S3 C13, S3 C10, ME, S4 C14, S4 C13, S4 C10, ME
A4	DISC 4	IF Z1, IF Z2, S3 C14, S3 C13, S3 C11, ME, S4 C14, S4 C13, S4 C11, ME
A5	DISC 5	IF Z1, IF Z2, S3 C14, S3 C13, S3 C12, ME, S4 C14, S4 C13, S4 C12, ME
A6	CD SHUFFLE	IF Z1, IF Z2, S3 C14, S3 C6, S3 C1, S4 C14, S4 C6, S4 C1
A7	FM PSET-1	IF Z1, IF Z2, S1 C3, ME, S2 C3, ME
A8	FM PSET-2	IF Z1, IF Z2, S1 C4, ME, S2 C4, ME
A9	SYS OFF	SYSTEM OFF
B1	FM-1	SYSTEM ON, Z1 S1, Z2 S1, Z2 UNMUTE
B2	NEXT	IF Z1, IF Z2, S1 C1, S2 C1, S3 C3, S4 C3
B3	FM-2	SYSTEM ON, Z1 S2, Z2 S2, Z2 UNMUTE
B4	LAST	IF Z1, IF Z2, S1 C2, S2 C2, S3 C5, S4 C5
B5	CD-1	SYSTEM ON, Z1 S3, Z2 S3, S3 C1, Z2 UNMUTE
B6	VOL UP	ZONE 2, VOLUME UP
B7	CD-2	SYSTEM ON, Z1 S4, Z2 S4, S4 C1, Z2 UNMUTE
B8	VOL DN	ZONE 2, VOLUME DOWN
B9	MUTE	ZONE 2, MUTE / UNMUTE

Stations 4 and 5

Zone 2

PUSH / HOLD FUNCTIONS

A1	DISC 1	
A2	DISC 2	
A3	DISC 3	
A4	DISC 4	
A5	DISC 5	
A6	CD SHUFFLE	IF Z1, IF Z2, S3 C14, S3 C13, S3 C1, S4 C14, S4 C13, S4 C1
A7	FM PSET-1	
A8	FM PSET-2	
A9	SYS OFF	SYSTEM OFF
B1	FM-1	
B2	NEXT	IF Z1, IF Z2, S3 C14, S3 C13, S3 C4, S4 C14, S4 C13, S4 C4
B3	FM-2	
B4	LAST	IF Z1, IF Z2, S3 C2, S4 C2
B5	CD-1	IF Z1, IF Z2, S3 C14, S3 C13, S3 C7
B6	VOL UP	ZONE 2, VOLUME UP
B7	CD-2	IF Z1, IF Z2, S4 C14, S4 C13, S4 C7
B8	VOL DN	ZONE 2, VOLUME DOWN
B9	MUTE	SYSTEM OFF

<u>SOURCE</u>	<u>#</u>	<u>COMMAND</u>
FM 1 OR 2	1	PSET-UP
FM 1 OR 2	2	PSET-DN
FM 1 OR 2	3	PSET 1
FM 1 OR 2	4	PSET 2
CD 1 OR 2	1	PLAY
CD 1 OR 2	2	PAUSE
CD 1 OR 2	3	NXT TRACK
CD 1 OR 2	4	NXT DISC
CD 1 OR 2	5	LAST TRACK
CD 1 OR 2	6	SHUFFLE
CD 1 OR 2	7	STOP
CD 1 OR 2	8	DISC 1
CD 1 OR 2	9	DISC 2
CD 1 OR 2	10	DISC 3
CD 1 OR 2	11	DISC 4
CD 1 OR 2	12	DISC 5
CD 1 OR 2	13	CONTINUE
CD 1 OR 2	14	PROGRAM

Station 6
Zone 2

D46 CONFIGURATION DATA / ZONE 2

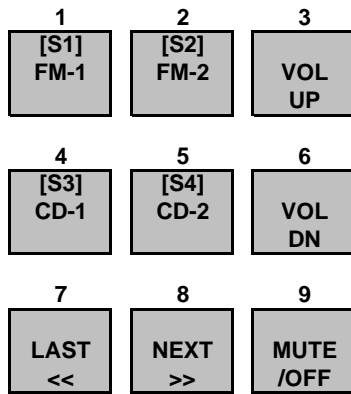

CS# 6

PUSH / RELEASE FUNCTIONS

1	FM-1	SYS ON, Z1 S1, Z2 S1, Z2 UNMUTE
2	FM-2	SYS ON, Z1 S2, Z2 S2, Z2 UNMUTE
3	VOL UP	Z2 VOLUME UP
4	CD-1	SYS ON, Z1 S3, Z2 S3, S3 C1, Z2 UNMUTE
5	CD-2	SYS ON, Z1 S4, Z2 S4, S4 C1, Z2 UNMUTE
6	VOL DN	Z2 VOLUME DOWN
7	LAST	IF Z1, IF Z2, S1 C2, S2 C2, S3 C5, S4 C5
8	NEXT	IF Z1, IF Z2, S1 C1, S2 C1, S3 C3, S4 C3
9	MUTE/OFF	Z2 MUTE/UNMUTE

PUSH / HOLD FUNCTIONS

1	FM 1	
2	FM-2	
3	VOL UP	Z2 VOLUME UP
4	CD-1	IF Z1, IF Z2, S3 C14, S3 C13, S3 C7
5	CD-2	IF Z1, IF Z2, S4 C14, S4 C13, S4 C7
6	VOL DN	Z2 VOLUME DN
7	LAST	IF Z1, IF Z2, S3 C2, S4 C2
8	NEXT	IF Z1, IF Z2, S3 C14, S3 C13, S3 C4, S4 C14, S4 C13, S4 C4
9	MUTE/OFF	SYSTEM OFF

Station 6Zone 2

<u>SOURCE</u>	<u>#</u>	<u>COMMAND</u>
FM 1 OR 2	1	PSET UP
FM 1 OR 2	2	PSET DN
FM 1 OR 2	3	PSET 1
FM 1 OR 2	4	PSET 2
CD 1 OR 2	1	PLAY
CD 1 OR 2	2	PAUSE
CD 1 OR 2	3	NXT TRACK
CD 1 OR 2	4	NXT DISC
CD 1 OR 2	5	LAST TRACK
CD 1 OR 2	6	SHUFFLE (NOT USED)
CD 1 OR 2	7	STOP
CD 1 OR 2	13	CONTINUE
CD 1 OR 2	14	PROGRAM

Stations 7 and 8

Zone 3

D46 CONFIGURATION DATA / ZONE 3

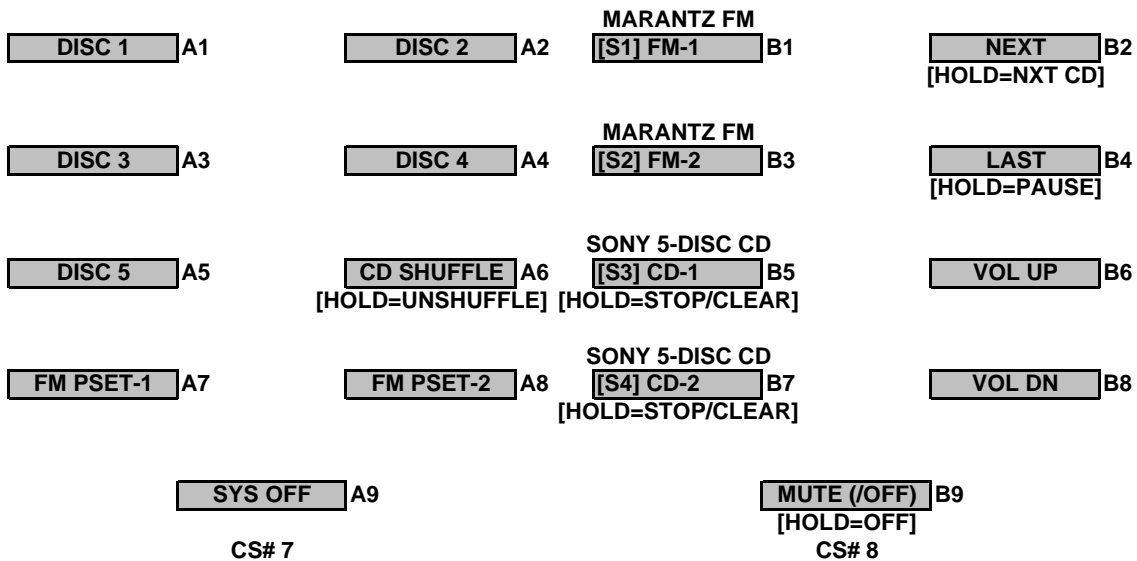

PUSH / RELEASE FUNCTIONS

A1	DISC 1	IF Z3, S3 C14, S3 C13, S3 C8, ME, S4 C14, S4 C13, S4 C8, ME
A2	DISC 2	IF Z3, S3 C14, S3 C13, S3 C9, ME, S4 C14, S4 C13, S4 C9, ME
A3	DISC 3	IF Z3, S3 C14, S3 C13, S3 C10, ME, S4 C14, S4 C13, S4 C10, ME
A4	DISC 4	IF Z3, S3 C14, S3 C13, S3 C11, ME, S4 C14, S4 C13, S4 C11, ME
A5	DISC 5	IF Z3, S3 C14, S3 C13, S3 C12, ME, S4 C14, S4 C13, S4 C12, ME
A6	CD SHUFFLE	IF Z3, S3 C14, S3 C6, S3 C1, S4 C14, S4 C6, S4 C1
A7	FM PSET-1	IF Z3, S1 C3, ME, S2 C3, ME
A8	FM PSET-2	IF Z3, S1 C4, ME, S2 C4, ME
A9	SYS OFF	SYSTEM OFF
B1	FM-1	SYSTEM ON, Z3 S1, Z3 UNMUTE
B2	NEXT	IF Z3, S1 C1, S2 C1, S3 C3, S4 C3
B3	FM-2	SYSTEM ON, Z3 S2, Z3 UNMUTE
B4	LAST	IF Z3, S1 C2, S2 C2, S3 C5, S4 C5
B5	CD-1	SYSTEM ON, Z3 S3, S3 C1, Z3 UNMUTE
B6	VOL UP	ZONE 3, VOLUME UP
B7	CD-2	SYSTEM ON, Z3 S4, S4 C1, Z3 UNMUTE
B8	VOL DN	ZONE 3, VOLUME DOWN
B9	MUTE	ZONE 3, MUTE / UNMUTE

Stations 7 and 8

Zone 3

PUSH / HOLD FUNCTIONS

A1	DISC 1	
A2	DISC 2	
A3	DISC 3	
A4	DISC 4	
A5	DISC 5	
A6	CD SHUFFLE	IF Z3, S3 C14, S3 C13, S3 C1, S4 C14, S4 C13, S4 C1
A7	FM PSET-1	
A8	FM PSET-2	
A9	SYS OFF	SYSTEM OFF
B1	FM-1	
B2	NEXT	IF Z3, S3 C14, S3 C13, S3 C4, S4 C14, S4 C13, S4 C4
B3	FM-2	
B4	LAST	IF Z3, S3 C2, S4 C2
B5	CD-1	IF Z3, S3 C14, S3 C13, S3 C7
B6	VOL UP	ZONE 3, VOLUME UP
B7	CD-2	IF Z3, S4 C14, S4 C13, S4 C7
B8	VOL DN	ZONE 3, VOLUME DOWN
B9	MUTE	SYSTEM OFF

<u>SOURCE</u>	<u>#</u>	<u>COMMAND</u>
FM 1 OR 2	1	PSET-UP
FM 1 OR 2	2	PSET-DN
FM 1 OR 2	3	PSET 1
FM 1 OR 2	4	PSET 2
CD 1 OR 2	1	PLAY
CD 1 OR 2	2	PAUSE
CD 1 OR 2	3	NXT TRACK
CD 1 OR 2	4	NXT DISC
CD 1 OR 2	5	LAST TRACK
CD 1 OR 2	6	SHUFFLE
CD 1 OR 2	7	STOP
CD 1 OR 2	8	DISC 1
CD 1 OR 2	9	DISC 2
CD 1 OR 2	10	DISC 3
CD 1 OR 2	11	DISC 4
CD 1 OR 2	12	DISC 5
CD 1 OR 2	13	CONTINUE
CD 1 OR 2	14	PROGRAM

Station 9

Zone 3

D46 CONFIGURATION DATA / ZONE 3

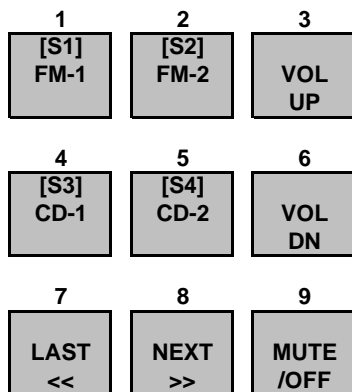

CS# 9

PUSH / RELEASE FUNCTIONS

1	FM-1	SYS ON, Z3 S1, Z3 UNMUTE
2	FM-2	SYS ON, Z3 S2, Z3 UNMUTE
3	VOL UP	Z3 VOLUME UP
4	CD-1	SYS ON, Z3 S3, S3 C1, Z3 UNMUTE
5	CD-2	SYS ON, Z3 S4, S4 C1, Z3 UNMUTE
6	VOL DN	Z3 VOLUME DOWN
7	LAST	IF Z3, S1 C2, S2 C2, S3 C5, S4 C5
8	NEXT	IF Z3, S1 C1, S2 C1, S3 C3, S4 C3
9	MUTE/OFF	Z3 MUTE/UNMUTE

PUSH / HOLD FUNCTIONS

1	FM 1	
2	FM-2	
3	VOL UP	Z3 VOLUME UP
4	CD-1	IF Z3, S3 C14, S3 C13, S3 C7
5	CD-2	IF Z3, S4 C14, S4 C13, S4 C7
6	VOL DN	Z3 VOLUME DN
7	LAST	IF Z3, S3 C2, S4 C2
8	NEXT	IF Z3, S3 C14, S3 C13, S3 C4, S4 C14, S4 C13, S4 C4
9	MUTE/OFF	SYSTEM OFF

Station 9Zone 3

<u>SOURCE</u>	<u>#</u>	<u>COMMAND</u>
FM 1 OR 2	1	PSET UP
FM 1 OR 2	2	PSET DN
FM 1 OR 2	3	PSET 1
FM 1 OR 2	4	PSET 2
CD 1 OR 2	1	PLAY
CD 1 OR 2	2	PAUSE
CD 1 OR 2	3	NXT TRACK
CD 1 OR 2	4	NXT DISC
CD 1 OR 2	5	LAST TRACK
CD 1 OR 2	6	SHUFFLE (NOT USED)
CD 1 OR 2	7	STOP
CD 1 OR 2	13	CONTINUE
CD 1 OR 2	14	PROGRAM

Station 10
Zone 4

D46 CONFIGURATION DATA / ZONE 4

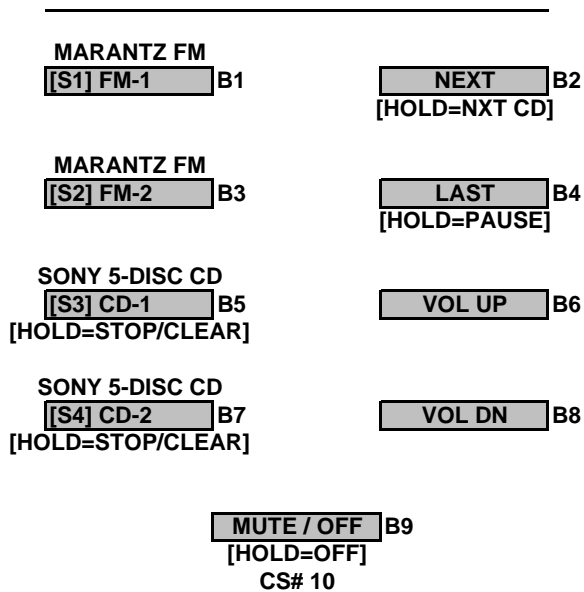

PUSH / RELEASE FUNCTIONS

B1	FM-1	SYSTEM ON, Z4 S1, Z4 UNMUTE
B2	NEXT	IF Z4, S1 C1, S2 C1, S3 C3, S4 C3
B3	FM-2	SYSTEM ON, Z4 S2, Z4 UNMUTE
B4	LAST	IF Z4, S1 C2, S2 C2, S3 C5, S4 C5
B5	CD-1	SYSTEM ON, Z4 S3, S3 C1, Z4 UNMUTE
B6	VOL UP	ZONE 4, VOLUME UP
B7	CD-2	SYSTEM ON, Z4 S4, S4 C1, Z4 UNMUTE
B8	VOL DN	ZONE 4, VOLUME DOWN
B9	MUTE	ZONE 4, MUTE / UNMUTE

Station 10
Zone 4

PUSH / HOLD FUNCTIONS

B1	FM-1	
B2	NEXT	IF Z4, S3 C14, S3 C13, S3 C4, S4 C14, S4 C13, S4 C4
B3	FM-2	
B4	LAST	IF Z4, S3 C2, S4 C2
B5	CD-1	IF Z4, S3 C14, S3 C13, S3 C7
B6	VOL UP	ZONE 4, VOLUME UP
B7	CD-2	IF Z4, S4 C14, S4 C13, S4 C7
B8	VOL DN	ZONE 4, VOLUME DOWN
B9	MUTE	SYSTEM OFF

<u>SOURCE</u>	<u>#</u>	<u>COMMAND</u>
FM 1 OR 2	1	PSET-UP
FM 1 OR 2	2	PSET-DN
FM 1 OR 2	3	PSET 1
FM 1 OR 2	4	PSET 2
CD 1 OR 2	1	PLAY
CD 1 OR 2	2	PAUSE
CD 1 OR 2	3	NXT TRACK
CD 1 OR 2	4	NXT DISC
CD 1 OR 2	5	LAST TRACK
CD 1 OR 2	6	SHUFFLE
CD 1 OR 2	7	STOP
CD 1 OR 2	8	DISC 1
CD 1 OR 2	9	DISC 2
CD 1 OR 2	10	DISC 3
CD 1 OR 2	11	DISC 4
CD 1 OR 2	12	DISC 5
CD 1 OR 2	13	CONTINUE
CD 1 OR 2	14	PROGRAM

Station 11

Zone 4

D46 CONFIGURATION DATA / ZONE 4

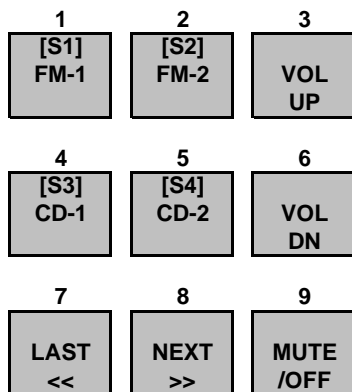

CS# 11

PUSH / RELEASE FUNCTIONS

1	FM-1	SYS ON, Z4 S1, Z4 UNMUTE
2	FM-2	SYS ON, Z4 S2, Z4 UNMUTE
3	VOL UP	Z4 VOLUME UP
4	CD-1	SYS ON, Z4 S3, S3 C1, Z4 UNMUTE
5	CD-2	SYS ON, Z4 S4, S4 C1, Z4 UNMUTE
6	VOL DN	Z4 VOLUME DOWN
7	LAST	IF Z4, S1 C2, S2 C2, S3 C5, S4 C5
8	NEXT	IF Z4, S1 C1, S2 C1, S3 C3, S4 C3
9	MUTE/OFF	Z4 MUTE/UNMUTE

PUSH / HOLD FUNCTIONS

1	FM 1	
2	FM-2	
3	VOL UP	Z4 VOLUME UP
4	CD-1	IF Z4, S3 C14, S3 C13, S3 C7
5	CD-2	IF Z4, S4 C14, S4 C13, S4 C7
6	VOL DN	Z4 VOLUME DN
7	LAST	IF Z4, S3 C2, S4 C2
8	NEXT	IF Z4, S3 C14, S3 C13, S3 C4, S4 C14, S4 C13, S4 C4
9	MUTE/OFF	SYSTEM OFF

Station 11

Zone 4

<u>SOURCE</u>	<u>#</u>	<u>COMMAND</u>
FM 1 OR 2	1	PSET UP
FM 1 OR 2	2	PSET DN
FM 1 OR 2	3	PSET 1
FM 1 OR 2	4	PSET 2
CD 1 OR 2	1	PLAY
CD 1 OR 2	2	PAUSE
CD 1 OR 2	3	NXT TRACK
CD 1 OR 2	4	NXT DISC
CD 1 OR 2	5	LAST TRACK
CD 1 OR 2	6	SHUFFLE (NOT USED)
CD 1 OR 2	7	STOP
CD 1 OR 2	13	CONTINUE
CD 1 OR 2	14	PROGRAM

Station 12
Zone 5

D46 CONFIGURATION DATA / ZONE 5

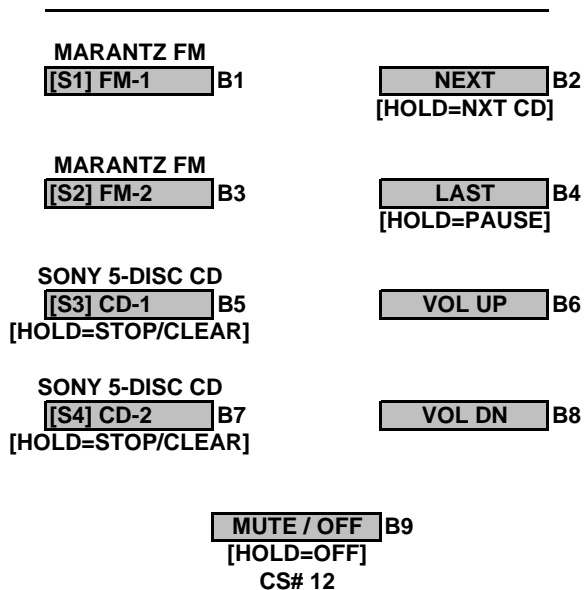

PUSH / RELEASE FUNCTIONS

B1	FM-1	SYSTEM ON, Z5 S1, Z5 UNMUTE
B2	NEXT	IF Z5, S1 C1, S2 C1, S3 C3, S4 C3
B3	FM-2	SYSTEM ON, Z5 S2, Z5 UNMUTE
B4	LAST	IF Z5, S1 C2, S2 C2, S3 C5, S4 C5
B5	CD-1	SYSTEM ON, Z5 S3, S3 C1, Z5 UNMUTE
B6	VOL UP	ZONE 5, VOLUME UP
B7	CD-2	SYSTEM ON, Z5 S4, S4 C1, Z5 UNMUTE
B8	VOL DN	ZONE 5, VOLUME DOWN
B9	MUTE	ZONE 5, MUTE / UNMUTE

Station 12
Zone 5

PUSH / HOLD FUNCTIONS

B1	FM-1	
B2	NEXT	IF Z5, S3 C14, S3 C13, S3 C4, S4 C14, S4 C13, S4 C4
B3	FM-2	
B4	LAST	IF Z5, S3 C2, S4 C2
B5	CD-1	IF Z5, S3 C14, S3 C13, S3 C7
B6	VOL UP	ZONE 5, VOLUME UP
B7	CD-2	IF Z5, S4 C14, S4 C13, S4 C7
B8	VOL DN	ZONE 5, VOLUME DOWN
B9	MUTE	SYSTEM OFF

<u>SOURCE</u>	<u>#</u>	<u>COMMAND</u>
FM 1 OR 2	1	PSET-UP
FM 1 OR 2	2	PSET-DN
FM 1 OR 2	3	PSET 1
FM 1 OR 2	4	PSET 2
CD 1 OR 2	1	PLAY
CD 1 OR 2	2	PAUSE
CD 1 OR 2	3	NXT TRACK
CD 1 OR 2	4	NXT DISC
CD 1 OR 2	5	LAST TRACK
CD 1 OR 2	6	SHUFFLE
CD 1 OR 2	7	STOP
CD 1 OR 2	8	DISC 1
CD 1 OR 2	9	DISC 2
CD 1 OR 2	10	DISC 3
CD 1 OR 2	11	DISC 4
CD 1 OR 2	12	DISC 5
CD 1 OR 2	13	CONTINUE
CD 1 OR 2	14	PROGRAM

Station 13

Zone 5

D46 CONFIGURATION DATA / ZONE 5

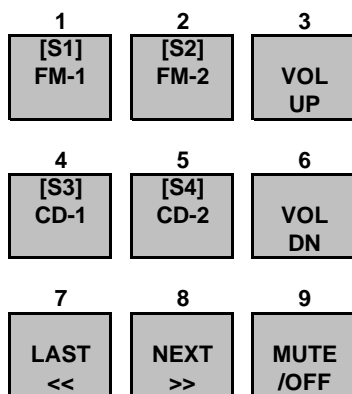

CS# 13

PUSH / RELEASE FUNCTIONS

1	FM-1	SYS ON, Z5 S1, Z5 UNMUTE
2	FM-2	SYS ON, Z5 S2, Z5 UNMUTE
3	VOL UP	Z5 VOLUME UP
4	CD-1	SYS ON, Z5 S3, S3 C1, Z5 UNMUTE
5	CD-2	SYS ON, Z5 S4, S4 C1, Z5 UNMUTE
6	VOL DN	Z5 VOLUME DOWN
7	LAST	IF Z5, S1 C2, S2 C2, S3 C5, S4 C5
8	NEXT	IF Z5, S1 C1, S2 C1, S3 C3, S4 C3
9	MUTE/OFF	Z5 MUTE/UNMUTE

PUSH / HOLD FUNCTIONS

1	FM 1	
2	FM-2	
3	VOL UP	Z5 VOLUME UP
4	CD-1	IF Z5, S3 C14, S3 C13, S3 C7
5	CD-2	IF Z5, S4 C14, S4 C13, S4 C7
6	VOL DN	Z5 VOLUME DN
7	LAST	IF Z5, S3 C2, S4 C2
8	NEXT	IF Z5, S3 C14, S3 C13, S3 C4, S4 C14, S4 C13, S4 C4
9	MUTE/OFF	SYSTEM OFF

Station 13Zone 5

<u>SOURCE</u>	<u>#</u>	<u>COMMAND</u>
FM 1 OR 2	1	PSET UP
FM 1 OR 2	2	PSET DN
FM 1 OR 2	3	PSET 1
FM 1 OR 2	4	PSET 2
CD 1 OR 2	1	PLAY
CD 1 OR 2	2	PAUSE
CD 1 OR 2	3	NXT TRACK
CD 1 OR 2	4	NXT DISC
CD 1 OR 2	5	LAST TRACK
CD 1 OR 2	6	SHUFFLE (NOT USED)
CD 1 OR 2	7	STOP
CD 1 OR 2	13	CONTINUE
CD 1 OR 2	14	PROGRAM

Station 14
Zone 6

D46 CONFIGURATION DATA / ZONE 6

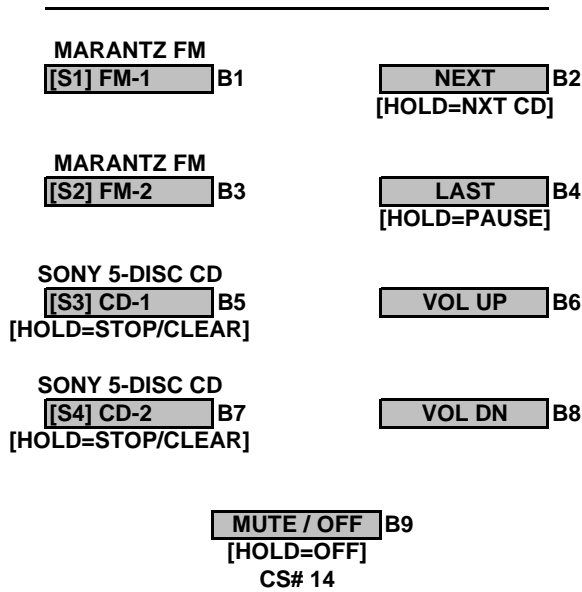

PUSH / RELEASE FUNCTIONS

B1	FM-1	SYSTEM ON, Z6 S1, Z6 UNMUTE
B2	NEXT	IF Z6, S1 C1, S2 C1, S3 C3, S4 C3
B3	FM-2	SYSTEM ON, Z6 S2, Z6 UNMUTE
B4	LAST	IF Z6, S1 C2, S2 C2, S3 C5, S4 C5
B5	CD-1	SYSTEM ON, Z6 S3, S3 C1, Z6 UNMUTE
B6	VOL UP	ZONE 6, VOLUME UP
B7	CD-2	SYSTEM ON, Z6 S4, S4 C1, Z5 UNMUTE
B8	VOL DN	ZONE 6, VOLUME DOWN
B9	MUTE	ZONE 6, MUTE / UNMUTE

Station 14

Zone 6

PUSH / HOLD FUNCTIONS

B1	FM-1	
B2	NEXT	IF Z6, S3 C14, S3 C13, S3 C4, S4 C14, S4 C13, S4 C4
B3	FM-2	
B4	LAST	IF Z6, S3 C2, S4 C2
B5	CD-1	IF Z6, S3 C14, S3 C13, S3 C7
B6	VOL UP	ZONE 6, VOLUME UP
B7	CD-2	IF Z6, S4 C14, S4 C13, S4 C7
B8	VOL DN	ZONE 6, VOLUME DOWN
B9	MUTE	SYSTEM OFF

<u>SOURCE</u>	<u>#</u>	<u>COMMAND</u>
FM 1 OR 2	1	PSET-UP
FM 1 OR 2	2	PSET-DN
FM 1 OR 2	3	PSET 1
FM 1 OR 2	4	PSET 2
CD 1 OR 2	1	PLAY
CD 1 OR 2	2	PAUSE
CD 1 OR 2	3	NXT TRACK
CD 1 OR 2	4	NXT DISC
CD 1 OR 2	5	LAST TRACK
CD 1 OR 2	6	SHUFFLE
CD 1 OR 2	7	STOP
CD 1 OR 2	8	DISC 1
CD 1 OR 2	9	DISC 2
CD 1 OR 2	10	DISC 3
CD 1 OR 2	11	DISC 4
CD 1 OR 2	12	DISC 5
CD 1 OR 2	13	CONTINUE
CD 1 OR 2	14	PROGRAM

Station 15

Zone 6

D46 CONFIGURATION DATA / ZONE 6 [SECOND CONTROL STATION]

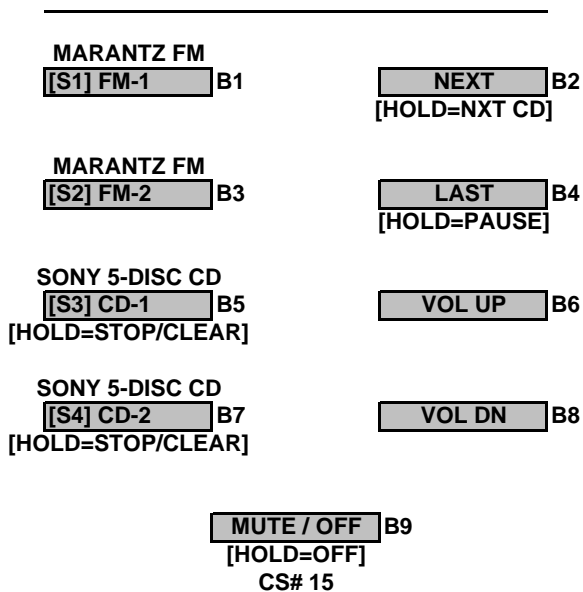

PUSH / RELEASE FUNCTIONS

B1	FM-1	SYSTEM ON, Z6 S1, Z6 UNMUTE
B2	NEXT	IF Z6, S1 C1, S2 C1, S3 C3, S4 C3
B3	FM-2	SYSTEM ON, Z6 S2, Z6 UNMUTE
B4	LAST	IF Z6, S1 C2, S2 C2, S3 C5, S4 C5
B5	CD-1	SYSTEM ON, Z6 S3, S3 C1, Z6 UNMUTE
B6	VOL UP	ZONE 6, VOLUME UP
B7	CD-2	SYSTEM ON, Z6 S4, S4 C1, Z5 UNMUTE
B8	VOL DN	ZONE 6, VOLUME DOWN
B9	MUTE	ZONE 6, MUTE / UNMUTE

Station 15

Zone 6

PUSH / HOLD FUNCTIONS

B1	FM-1	
B2	NEXT	IF Z6, S3 C14, S3 C13, S3 C4, S4 C14, S4 C13, S4 C4
B3	FM-2	
B4	LAST	IF Z6, S3 C2, S4 C2
B5	CD-1	IF Z6, S3 C14, S3 C13, S3 C7
B6	VOL UP	ZONE 6, VOLUME UP
B7	CD-2	IF Z6, S4 C14, S4 C13, S4 C7
B8	VOL DN	ZONE 6, VOLUME DOWN
B9	MUTE	SYSTEM OFF

<u>SOURCE</u>	<u>#</u>	<u>COMMAND</u>
FM 1 OR 2	1	PSET-UP
FM 1 OR 2	2	PSET-DN
FM 1 OR 2	3	PSET 1
FM 1 OR 2	4	PSET 2
CD 1 OR 2	1	PLAY
CD 1 OR 2	2	PAUSE
CD 1 OR 2	3	NXT TRACK
CD 1 OR 2	4	NXT DISC
CD 1 OR 2	5	LAST TRACK
CD 1 OR 2	6	SHUFFLE
CD 1 OR 2	7	STOP
CD 1 OR 2	8	DISC 1
CD 1 OR 2	9	DISC 2
CD 1 OR 2	10	DISC 3
CD 1 OR 2	11	DISC 4
CD 1 OR 2	12	DISC 5
CD 1 OR 2	13	CONTINUE
CD 1 OR 2	14	PROGRAM

Station 16

Zone 6

D46 CONFIGURATION DATA / ZONE 6

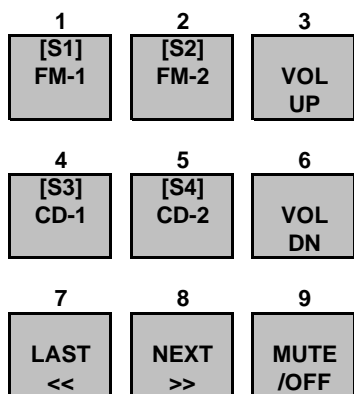

CS# 16

PUSH / RELEASE FUNCTIONS

1	FM-1	SYS ON, Z6 S1, Z6 UNMUTE
2	FM-2	SYS ON, Z6 S2, Z6 UNMUTE
3	VOL UP	Z6 VOLUME UP
4	CD-1	SYS ON, Z6 S3, S3 C1, Z6 UNMUTE
5	CD-2	SYS ON, Z6 S4, S4 C1, Z6 UNMUTE
6	VOL DN	Z6 VOLUME DOWN
7	LAST	IF Z6, S1 C2, S2 C2, S3 C5, S4 C5
8	NEXT	IF Z6, S1 C1, S2 C1, S3 C3, S4 C3
9	MUTE/OFF	Z6 MUTE/UNMUTE

PUSH / HOLD FUNCTIONS

1	FM 1	
2	FM-2	
3	VOL UP	Z6 VOLUME UP
4	CD-1	IF Z6, S3 C14, S3 C13, S3 C7
5	CD-2	IF Z6, S4 C14, S4 C13, S4 C7
6	VOL DN	Z6 VOLUME DN
7	LAST	IF Z6, S3 C2, S4 C2
8	NEXT	IF Z6, S3 C14, S3 C13, S3 C4, S4 C14, S4 C13, S4 C4
9	MUTE/OFF	SYSTEM OFF

Station 16Zone 6

<u>SOURCE</u>	<u>#</u>	<u>COMMAND</u>
FM 1 OR 2	1	PSET UP
FM 1 OR 2	2	PSET DN
FM 1 OR 2	3	PSET 1
FM 1 OR 2	4	PSET 2
CD 1 OR 2	1	PLAY
CD 1 OR 2	2	PAUSE
CD 1 OR 2	3	NXT TRACK
CD 1 OR 2	4	NXT DISC
CD 1 OR 2	5	LAST TRACK
CD 1 OR 2	6	SHUFFLE (NOT USED)
CD 1 OR 2	7	STOP
CD 1 OR 2	13	CONTINUE
CD 1 OR 2	14	PROGRAM

Index

A

Accessories 7-9
Acknowledgement 3-23
Addresses 4-67
Addressing Stations 3-8
Amplifiers 3-20
ANSI 4-2
Architectural Specifications 7-2
ASCII 7-38
Audio Cable 3-6
Audio Connections 7-3
Audio Inputs 7-3
Audio Outputs 7-3
Auto-off timer 4-12
Automation Systems 3-23

B

Bach 4-26
Back box 3-14
Balance 4-38
Balanced Line Driver 3-5
Bass 4-40 – 4-41
Bass Dwn 7-27
Bass Up 7-27
Baud rate 7-5
Baud rate 4-11
Bus 3-11
BX 3-15

C

Cable 3-13
Cable capacitance 5-6
Carver 7-7
CD changers 3-20
Change address 4-22
Class 1 wiring 3-15
Class 2 wiring 3-15
Clearing 4-60
Closure duration 4-14
Code Compliance 3-15
Conditional Statements 7-36
Conduit 3-15

Configurations 3-7
Configuring 4-8
Configuring Sources 4-43
Contact closure 7-3–7-4
Control Codes 7-7
Control delays 4-51
Copy macros 4-28

D

Daisy Chain 3-11
Default 4-32
Default volume 4-37
Delete 4-29
Deselected 4-54
Direct input 4-50, 5-9–5-10
Doorbells 3-21
Download 4-58, 4-60
Drawings 7-40
DSS 3-19
DSS presets 3-2

E

Edit 4-24
Editor keys 4-27
EEPROM 4-27–4-28
External control 4-10, 7-38
External home automation 4-52
External paging 4-13

F

Factory Default 7-42
Factory default 4-60
Factory defaults 4-64
File transfer 4-59
Finishes 7-8
FM tuners 3-20
Front panels 2-5

G

Goat skin 2-5
Greenfield 3-15
Grounding 3-16

H

Handy-boxes 3-14
Hardware problems 5-1–5-3
Help 5-13
Home Run Topologies 3-9
Homeowner's view 3-1
Hot Key 3-2

I

Input gain 4-48
Interconnect 4-18
Interconnecting Two Director
 Model 46s 3-22
IR carrier 4-50
IR code 4-45, 4-58
IR control 3-23
IR Control outputs 7-3 – 7-4
IR emitter 2-3, 4-50, 5-9 – 5-10

L

Last volume 4-37
Lighting 3-1
LiteTouch 7-4, 7-8

M

Machine control 4-45, 4-71, 5-9
Macro 4-1, 4-20, 7-27
Macro Editor 4-26
Marantz 3-16, 7-7
Master 3-22
McIntosh 7-7
Menu Overview 4-3
Mono zones 3-7
Mute 4-32, 7-27, 7-33

N

Network Connections 7-4
Network power 4-66–4-67
Network problems 5-3–5-4
New station 4-20
Null modem cable 3-22

O

Open duration 4-14
Optional Sources 3-21

P

Page 4-16
Page level 4-16
Paging 4-72, 7-3–7-4
Paging Input 3-21, 7-3
Parasound 7-7
Parasound tuner 5-9–5-10
Party 3-2
Phantom station 4-10
Phillips 7-7
Power 4-56
Power Control 7-4, 7-37
Power Outlets 7-5
Power switches 3-18
Power up sequence 4-8
Program switch 4-1
Programming Cable 7-9
Programming Worksheet 7-11

R

Ratcheting 3-18
RC5 4-44, 7-7
Reset button 2-3
Ring Topology 3-12
RS232 serial port 3-22
RS485 7-4

S

Serial Port 7-5
Short circuit 4-66
Shuffle 3-17
Slave 3-22
Sony 4-45, 7-7
Sony (S-bus) 3-16
Source Control 7-34
Source Deselect 4-11
Source power up 4-55 – 4-56
Source Selection 7-33
Specifications 7-1
Split 4-31
Split mono zone 3-7
Split zone 7-27
Station identification 4-68
Station Mounting 3-14
Station unresponsive 5-4 – 5-6
Status led 1-3, 5-3 – 5-4
Status query 7-39
System Diagnostics 4-65
System Planning
 Homeowner's View 3-1
 Installer's view 3-4

T

Terminal emulation 4-2 – 4-3
Test 4-69
Troubleshooting 5-1 – 5-3

U

Unmute 7-27, 7-32
Unmute All 7-33
Upload 4-61

V

Ventilation 3-5
Volume 4-32
Volume zones 3-3
VT100 4-2

W

Wall Station 7-8
Wiring, see also cable 3-6, 3-13

X

Xantech IR 5-11

Y

Yamaha 7-7

Z

Zmodem 4-2
Zones 4-30

AudioControl®

THIS IS THE BACK COVER



**Made in
America**

AudioControl

22410 70th Avenue West
Mountlake Terrace, WA 98043
Phone 425-775-8461 • Fax 425-778-3166

www.audiocontrol.com