

THE RICHTER SCALE CONSCIOUSNESS COURSE.

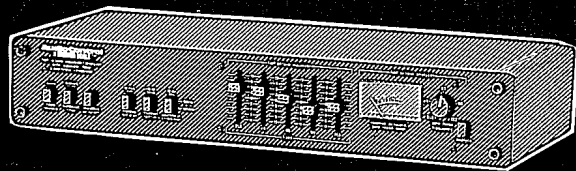

NETWORK.

radio with
d first

ANTEE.

it a
and

LIP
WAY

unlikely
n'll
the

re receipt

D-10 or D-11

d for

ags us to

on:

AL NUMBER

rthest

...things

rs don't

Congratulations on your taste (and bravery) in picking THE RICHTER SCALE.

Now it's our responsibility to show you how to use it. And that's a challenging job.

Because there are those of you who are virtual Electrical Engineers, and there are those of you who have bought this as part of your first real system and who don't know a phono jack from a Fig Newton.

So bear with us as we try to mix the basics with a little theory. Because a little theory helps when dealing bass and equalization. If our theory lectures seem a bit elementary, then write us and we'll lock equations with you EE types at twenty paces.

Even though you're dying to grab onto the thing and weave it into your system in a tangle of RCA cords, please take twenty minutes or so to read our sage advice on operating your new audio product. After all, it DOES have thirteen controls.

FIRST, THE PAPERWORK.

Before you control audio with your Audio Control, you should first control your eagerness and.....

FILL OUT THE WARRANTEE.

After you've played with it a while, give us a comment or two and send it in.

NEXT, PUT THE SALES SLIP OR STEREO STORE RECEIPT AWAY IN A SAFE PLACE.

It's *very important* in the unlikely event you'd ever need service. You'll get some some pretty blank looks from the store people if you don't have the receipt to prove when and where your RICHTER SCALE was purchased. Besides it's good for insurance purposes. Which brings us to the third important admonition:

RECORD THE SERIAL NUMBER OF YOUR UNIT.

Sure, theft is now the farthest thing from your mind, but, well....things DO happen and insurance adjusters don't have very big imaginations when you lack any proof you ever owned something.

Last (and this ends the nagging section), is to be sure and SAVE THE BOX. It would O.D. your garbage can anyway, and it will insure the safety of your analyzer should you move or need to return it for repair.

Okay. Onward to the good parts!

HOOKING UP THE RICHTER SCALE.

Unless the RICHTER SCALE is far-removed from the rest of your hi-fi, the best place to plug it in is the switched plug on the back of your amp or receiver. What?

There's already a turntable plugged into that socket? No sweat. Get a multiple socket or "splitter" from your local hardware store and plug both the RICHTER SCALE and your turntable in at once. Yes, this looks like it violates what Sparky the Firedog taught you about electrical safety in grade school. But not really. Combined, the turntable and RICHTER SCALE don't begin to exceed the wattage rating for a switched socket on a modern receiver.

Or, you can always just plug it into a wall socket.

First, by all means, turn off ALL equipment before hooking in the unit. A surprising number of audiophiles find their woofers on the floor after a 60-cycle buzz during hook-up.

The recommended way to hook in your unit is to put it in the tape monitor loop of your amp or receiver. That way you can activate it by pushing in the TAPE MON button. Look on the back of your amp or receiver for two or more sets of RCA sockets marked TAPE. Two will be marked OUT or REC; two will say IN or MON.

There may be two of these outlet socket groups. If so they will be marked "1" and "2".

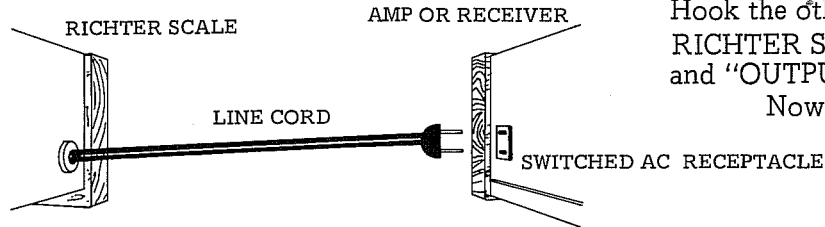

In any case, at least two will be marked "REC", "OUT", "REC OUT", or "TAPE OUT", and two will be marked "PLAY", "IN", "MON", or "PLAYBACK".

To connect the RICHTER SCALE into this circuit, plug the end of a set of connecting cords into the "REC"/"OUT" sockets on the back of the RICHTER SCALE labeled "INPUTS".

Make sure left and right at the amp are left and right at the RICHTER SCALE (red is generally used to denote right; white, black or grey represents left).

Now connect another set of connecting cords to the plugs on your amp marked "PLAY", "IN", "PLAYBACK", etc. Hook the other end of these cords to the RICHTER SCALE sockets marked "MAIN" and "OUTPUTS".

Now check the handy line drawing.

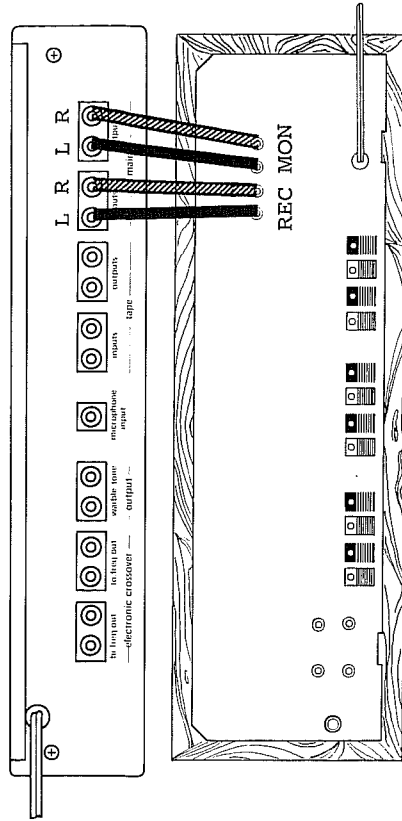

As connected, the RICHTER SCALE is now activated any time you press the "TAPE MONITOR" button on the control panel of your amp or receiver.

To prove it, 1) put on a record or FM. 2) Slide the RICHTER SCALE slider marked 125 all the way up. 3) Press the TAPE MON button on your receiver. 4) Press the EQUALIZER IN button on the RICHTER SCALE. You should hear a marked change in the sound. If you don't, check your connections.

HOOING IN OTHER OUTBOARD DEVICES.

Okay, that's fine for those of us who just have a regular system. But how about the gadget-o-phile. How do you hook up a RICHTER SCALE with lots of goodies.

We recommend placing other equalizers, dynamic expanders, click and pop filters, and special synthesizers JUST BEFORE the RICHTER SCALE.

Simply route the hook-up cord from TAPE OUT on your receiver to the INPUT of the device to the MAIN IN sockets on the Audio Control.

There's ONE EXCEPTION to this recommendation. Noise reduction devices such as Dolby *B, Dolby C, Sanyo or DBX 224, 122, 128, or 158 should be placed after the RICHTER SCALE and preferably in the tape circuit described above. (These brands of units artificially compress and equalize signals for encoding on tape.)

Note: Instructions for hooking up the RICHTER SCALE'S electronic crossover are farther on in the section titled "Bi-amping and Subwoofing."

Proceed and consider yourself lucky we didn't translate our manual out of broken Japanese.

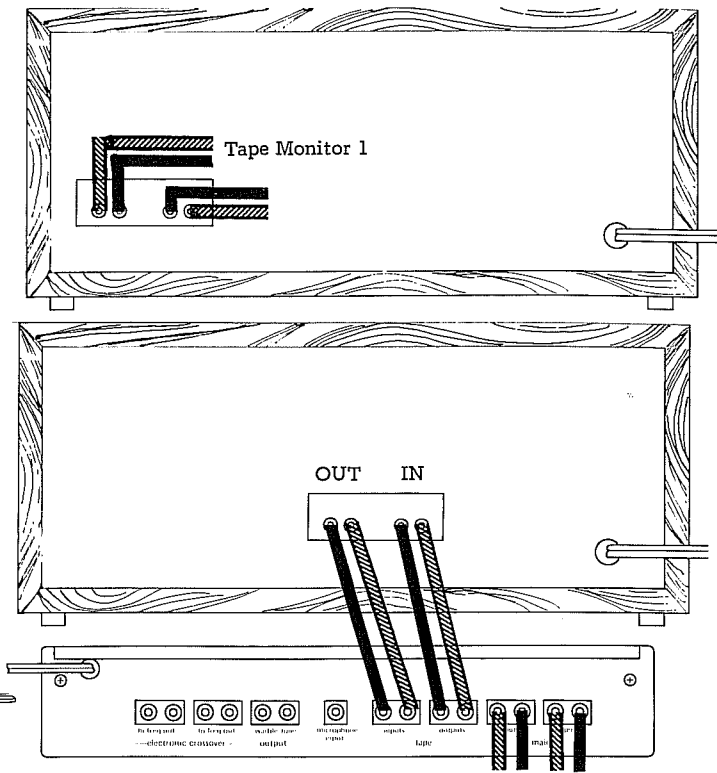
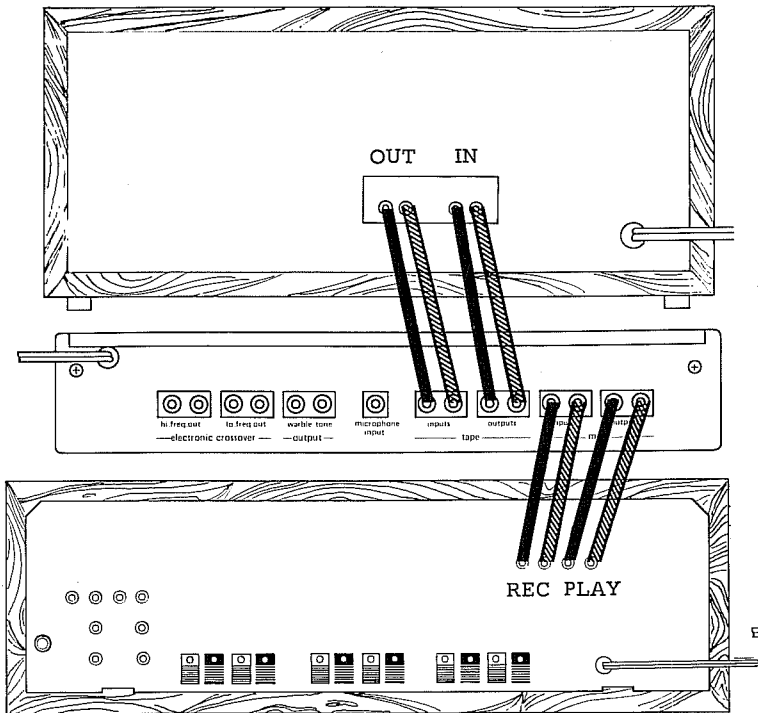

Tape Monitor 2

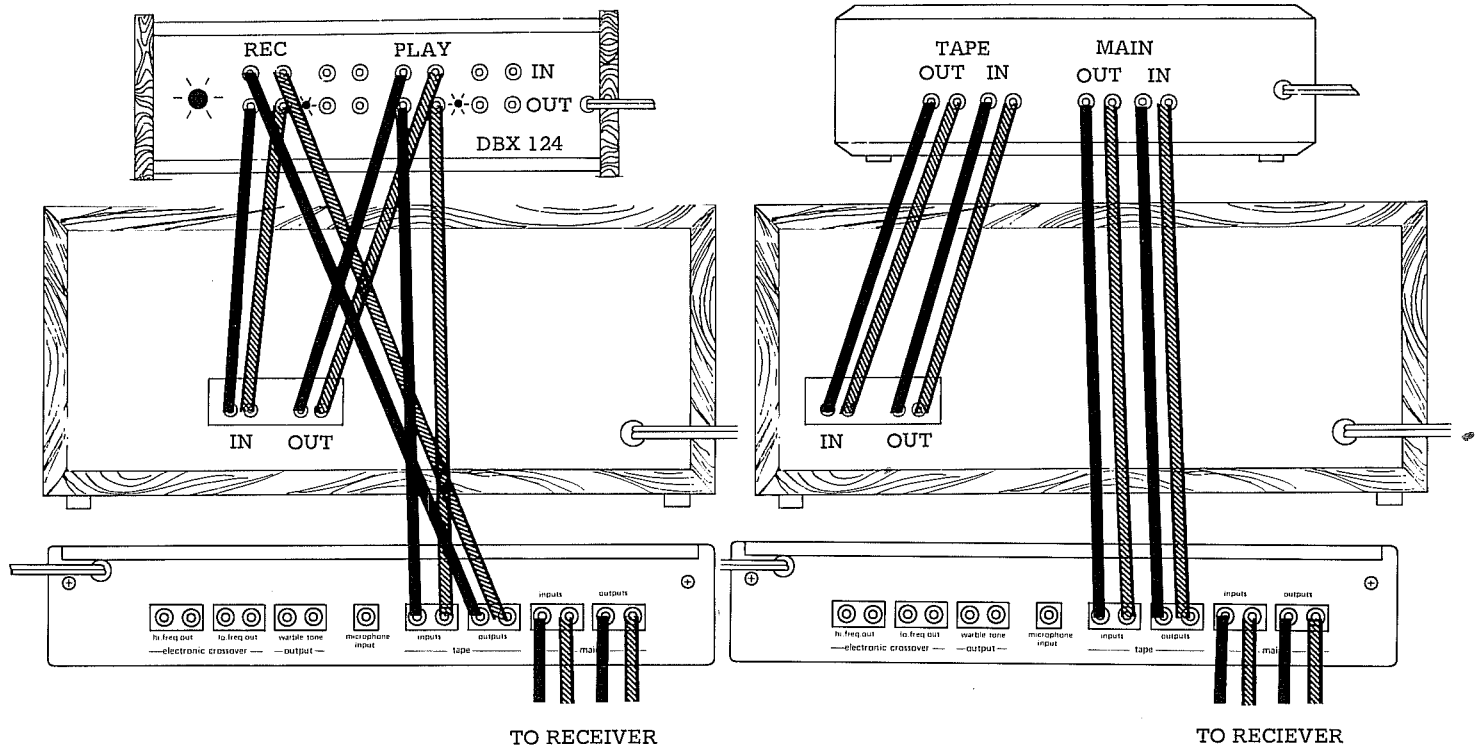

TO RECEIVER

TO RECIEVER

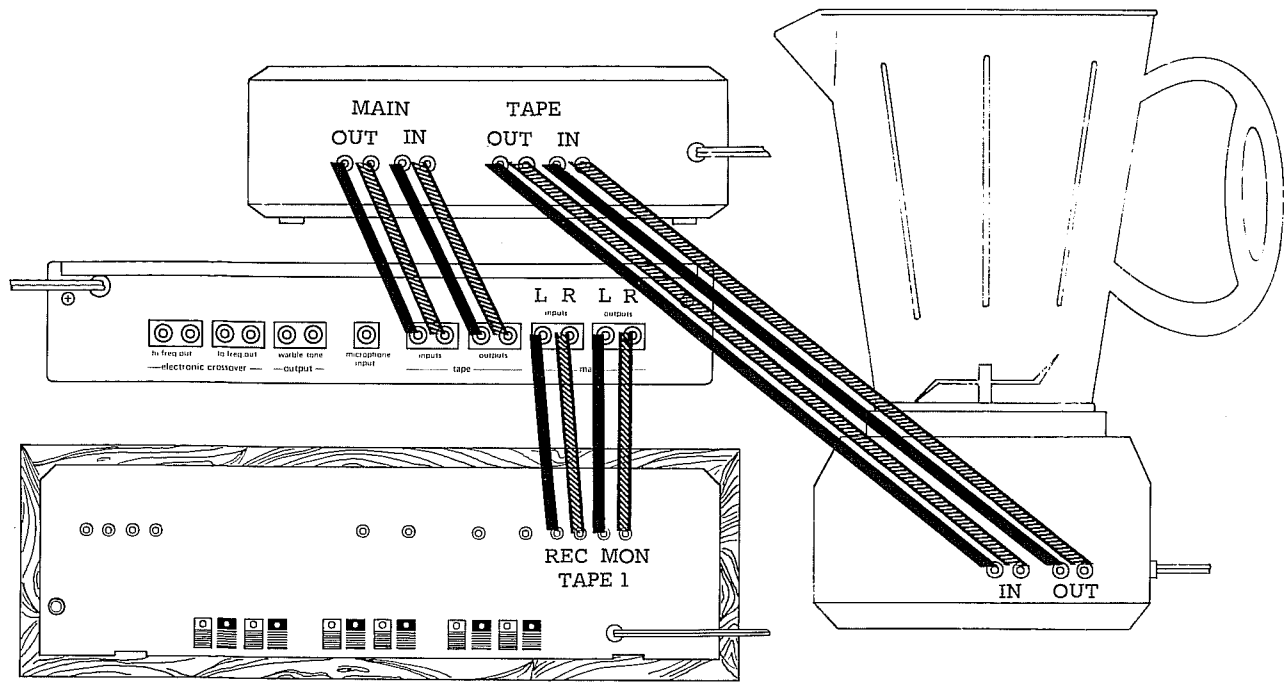

A GUIDED TOUR THROUGH THE GIZMOS.

First, here's a quick rundown of what all you're looking at on the front of the RICHTER SCALE. Then we'll handle hook-up and use of analyzer section, bash off a lengthy lecture on bi-amping and sub-woofing, and finish with hook-up and use of the electronic crossover section.

Left to right.....

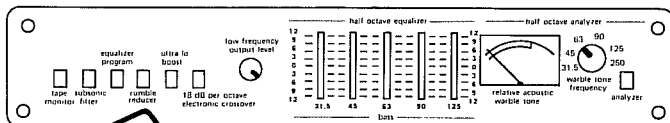

Rumble Reducer Button

CATCHING MONO IN THE BASS...THE PHASE CORRELATION RUMBLE REDUCER BUTTON.

The RICHTER SCALE octave equalizer has a circuit not found on any other stereo component being made in the world: A device that tightens up your system's bass response without even touching the equalizer's tone controls. Quite simply, this switch cuts turntable rumble, reduces acoustic feedback and even reduces the "thumps" that occur if you lower the cartridge too quickly onto a record.

About the best way to explain its function is to put on a record, boost bass, and then turn it up. Now click the rumble reduction button in and out. The difference can be dramatic. **NO OTHER EQUALIZER HAS A CIRCUIT SUCH AS THIS.** After you've tried it you'll see why. And you'll never switch it back out.

Now, STEREO is a wonderful phenomenon, and we have nothing against it. But, at very low frequencies – for most folks, under 200Hz – directionality and the stereo effect is totally un-noticeable. Bass drums and bass guitars just aren't mixed Left and Right in the stereo field, just put smack in the middle. So, this switch isn't affecting the accuracy of the music for 99.9% of listeners. Rather, it is making your electronics' job easier in an area fraught with inter-modulation and power supply difficulties.

You'll hear what we mean.

TAPE MONITOR.

Self-explanatory. Since we advocate placing the RICHTER SCALE in the tape monitor loop of your amp, preamp or receiver it is necessary to provide you with another tape monitor circuit for other addons, and of course, your tape recorder.

(Pushing the tape monitor circuit if other add ons, aren't connected opens up a non-circuit resulting in silence and frustration if you didn't notice it got pushed in.)

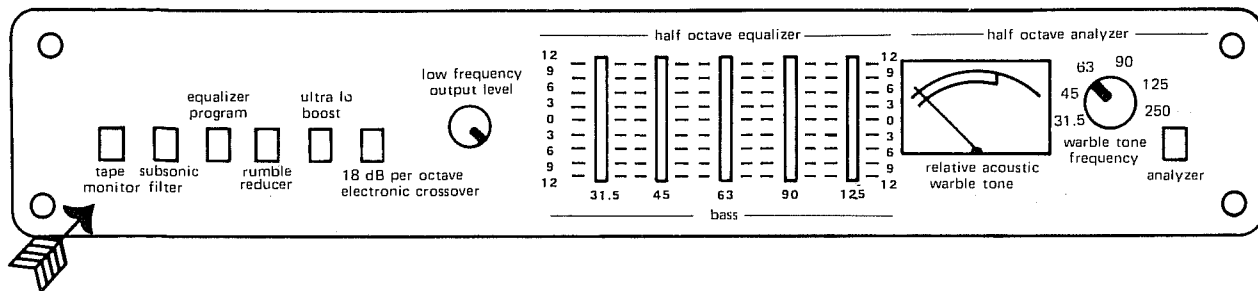

Tape Monitor

KILLING INVISIBLE MONSTERS OR YOU NEVER HAVE TO CLEAN YOUR SUBSONIC FILTER.

Subsonics are just what their name implies: Sound below the range of human hearing.

You don't need them.

In fact, you shouldn't have them.

Here's why. Your speakers insist on trying to waste energy and motion reproducing these inaudible, ultra-low frequency tones. Warped records, turntable rumble, the thump made when the tone arm is lifted off the record, the interference between stations when dialing FM or the feedback caused by placing a turntable close to the speakers can literally beat a woofer to death.

Amplifier power is wasted. And, since the speaker is trying to accommodate sound you don't hear, it messes up audible

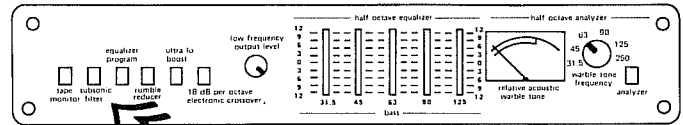

Subsonic Filter

sounds (intermodulation distortion), especially in a two-way system where the woofer is also handling some of the mid-range chores.

Reflex and vented speaker systems are particularly prone to this sort of potentially destructive woofer cone movement.

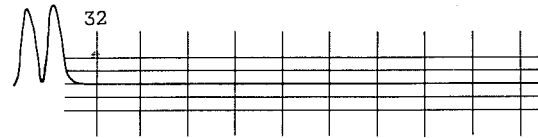

A SUBSONIC occurring below 32Hz.

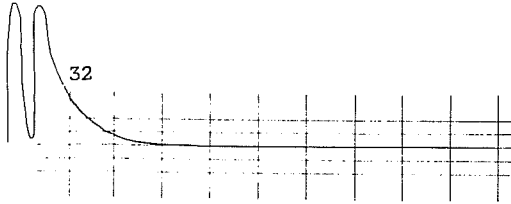

A SUBSONIC made more masty by boosting of 32Hz bass. That's why we added it: so you can boost the lowest AUDIBLE bass without encouraging destructive hanky-panky an octave below.

If you have such a system, ALWAYS leave the subsonic filter button on. To tell if your speaker system is vented, remove the grille cloth and look for a hole leading into the enclosure. If there is one and you can feel a motion of air when you play the system, you have a vented or reflex system rather than an acoustic suspension (sealed box) system.

Audio Control's RICHTER SCALE uses sophisticated 3-pole, 18dB per octave subsonic filter to do away with subsonic interference for good, and without any audible side effects. The bass response of your system will sound more solid and in most cases you can safely use a more powerful amplifier. Just press the button... not a bad deal!

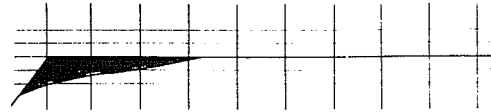

COMPARISON of the usual puny 6dB/octave subsonic filter found in many receivers and amps (lower line) with macho 18dB/octave subsonic filter in Richter Scale. Shaded area is the gain in audible bass.

EQUALIZE PROGRAM.

Think of this button as a comparator, to be used to check the equalized sound vs. old-style sound.

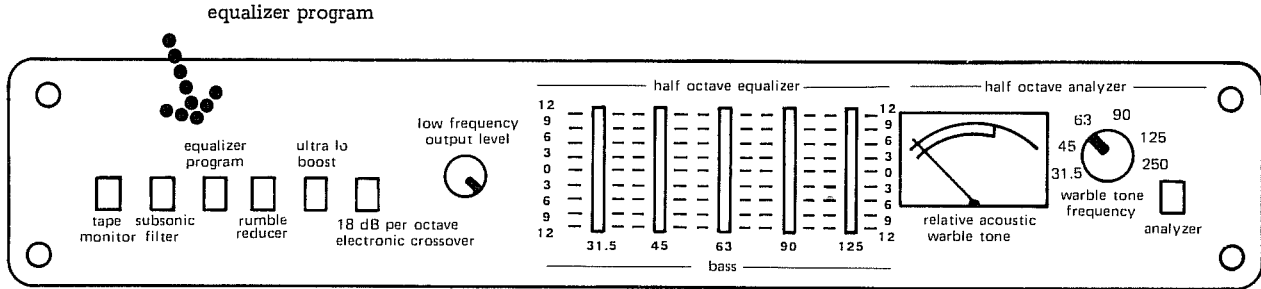

ULTRA-LOW BASS BOOST.

This circuit boosts an octave wide band centered at a whopping 15dB with the desultory depression of a digit.

Your first reaction is probably "Overkill!" Added to the half-octave section, that could add up to mondo bass.

Please understand our philosophy in adding this circuit.

Many of us at Audio Control have been involved with the studio recording industry in one capacity or another. We have been annoyed first hand by how much bass is lost in the recording process.

The best analog tape recorder currently made is 5dB down at 60Hz. It records on tape which is 3dB down at 50Hz. Figure three generations of tape later (with corresponding roll-offs), a mastering technician has to shoe-horn 20+ minutes onto a single 12" slide. That requires eliminating even more ultra-low bass to avoid super-deep (and wide) grooves. The result is a MASSIVE roll-off in "real-world" records ultra low bass.

As much as 30dB at 34Hz.

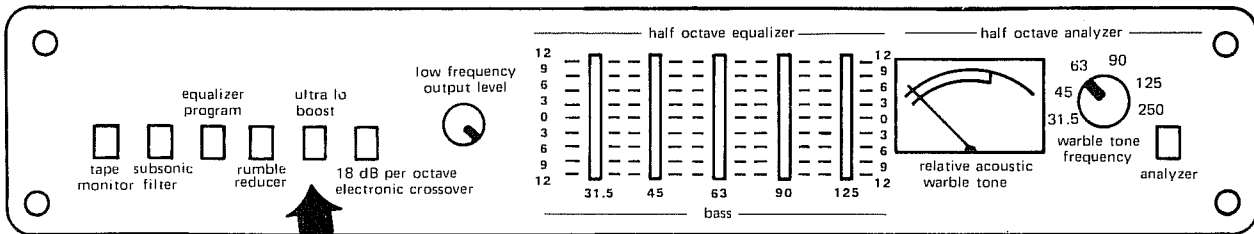

Ultra low bass boost

Thus, if your listening tastes run to studio-recorded pop or country, chances are, the RICHTER SCALE'S Ultra-low Bass Boost button can be activated without doing much more than returning part of the lost low bass.

Certainly this is not a button to leave on during all records. Digitally recorded records have all the bass they need.

So do specially-mastered disco, direct-to-disc and audiophile 45 RPM records.

But contemporary pop--even specially "re-mastered" records--definitely regain some of the lost last octave of bass which older technology simply couldn't capture. Newer pressings vary depending on how the record was recorded. Records with considerable room resonance tend to sound more hollow with the Ultra-Low Bass Boost circuit activated.

Be your own judge.

But remember, even with the button on and the 31.5 slider at +12, you're still not hearing as much bass as went down onto that master tape.

Also a word of warning. Any low bass boost increases subsonics, feedback and rumble. Don't push the Ultra-Low Bass Boost button unless subsonic and Rumble Reduction circuit buttons are pushed also.

18dB PER OCTAVE ELECTRONIC CROSSOVER.

The RICHTER SCALE'S electronic crossover is a separate circuit which can operate independently of the rest of the circuits. Thus you really have three outputs:

1. Full band (from the main out sockets)
2. Low pass (from the Xovers)
3. High pass (from the Xover)

There are just two controls for the crossover section.

FREQUENCY SELECT.

This determines the crossover point of the circuit. IN the crossover feeds under-100Hz into the LOW OUT sockets and above-100Hz into the HIGH OUT sockets. OUT, the crossover point is moved up to 800Hz.

Which setting to use (if any) is covered farther on.

The thing to remember is NOT to push the frequency select button IN if you are bi-amping at 800Hz. That would lower the crossover point to 100Hz, shunting all frequencies from 800 to 100 into the poor unprotected tweeter which might hysterically react by self-immolation.

Frequency Select

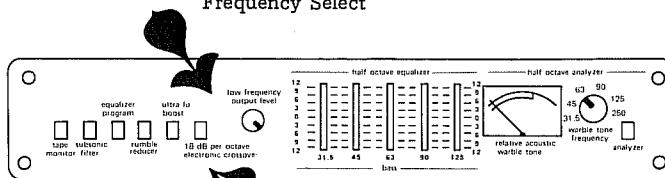

18dB per octave electronic crossover

LOW FREQUENCY OUTPUT LEVEL.

Is used to blend the low and high products in bi-amp and subwoofing situations by adjusting low output. It also allows you to use power amps which do not have gain controls.

HALF OCTAVE EQUALIZER.

Each half-octave band deserves a few comments.

31.5. This is really low. Assuming you have a program source with adequate 31.5, you may not have woofers capable of creating this frequency. Or power to drive the woofers if they do have sufficient cone area and voice coil excursion. Fully reproduced, it is the absolute "base" of audible sound, more felt than heard. Awesome. And worth investing in a subwoofer to hear.

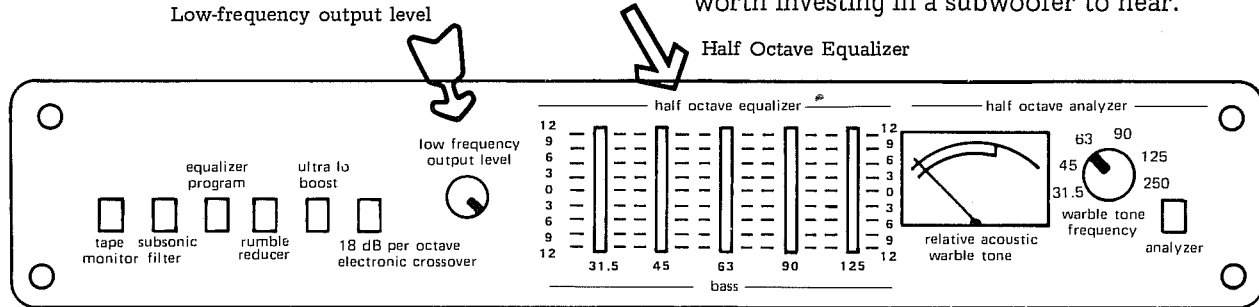

45Hz. This is realistically as low as most bass information to boost this band, since most loudspeakers roll-off in this range.

63Hz. Is the bass you were always trying to get with loudness buttons and bass controls. Deep audible bass. There's quite a bit if this bass in pop and rock music recordings and boosting this frequency can tax an amps output more than lower frequencies which have gotten rolled off in the mastering and recording processes. Quite often 60Hz is the center of room resonance problems, depending on size and speaker placement. You may have to decrease this band during warble analysis.

90Hz and 120Hz are also frequency bands you may find you have too much of. Some producers and engineers exaggerate this frequency to pander to really cheap teenybop/AM hi-fi's. We'll assume you have speakers which don't come with a 120Hz "bonk", designed in. But room resonance and program source boosts can often necessitate a cut here, anyway.

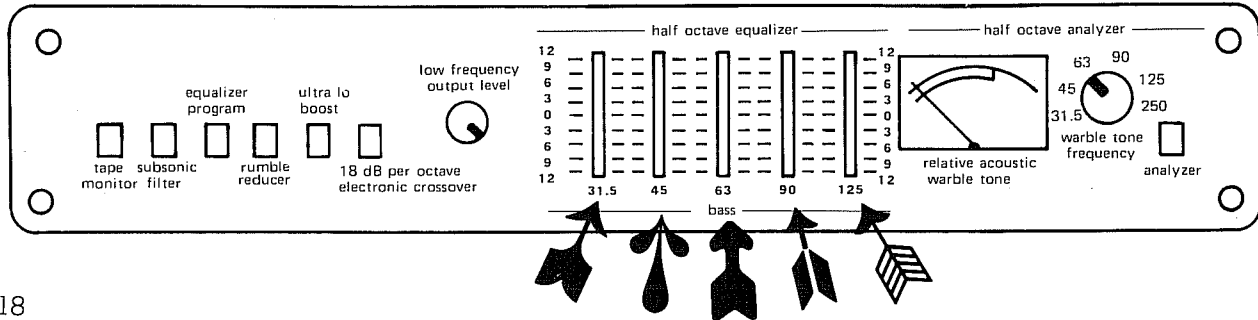

HALF OCTAVE ANALYZER.

Adjusting speaker response in the last three octaves is nearly impossible to do with just the naked ear. You're "hearing" them with more than just your ears. That's why we built in a half-octave warble tone generator and meter.

The meter is designed to be very sluggish, in order to average out variations in the warble tone and decrease extraneous transient sounds during testing.

The warble tone frequency center is set with the warble tone frequency knob (makes sense). It will also produce warbles with band widths other than those indicated band centers shown. Try twiddling it quickly to amaze your friends and send dogs scurrying for cover.

The analyze button at the far right of the RICHTER SCALE activates the dB meter circuitry and light. When you don't want to be distracted by sluggishly dancing meter movements, you can turn it off.

It does not, however, actually turn the whole unit off. The RICHTER SCALE is designed to be left on at all times.

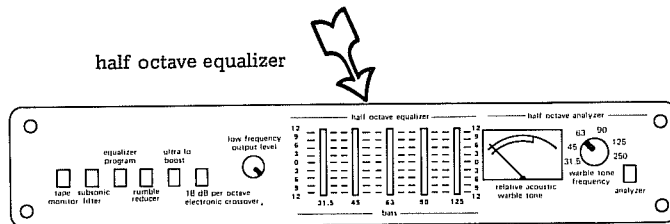

MAKING THE WARBLE WARBLE.

Blow the cobwebs off the input jacks marked AUX on the back of your amp or receiver. Finally, you're gonna use them for something!

Now locate the sockets on the back of the R/S marked "WARBLE TONE". Take the sets of patch cords provided and hook the sockets on the R/S to the AUX inputs on your receiver back. Left and right don't much matter since the output is mono anyway.

Now fire up your trusty receiver, turn the input selector to AUX and listen for the Star-Wars type sound.

That's warble tone. Twiddle the R/S warble tone frequency knob and notice the change in sound.

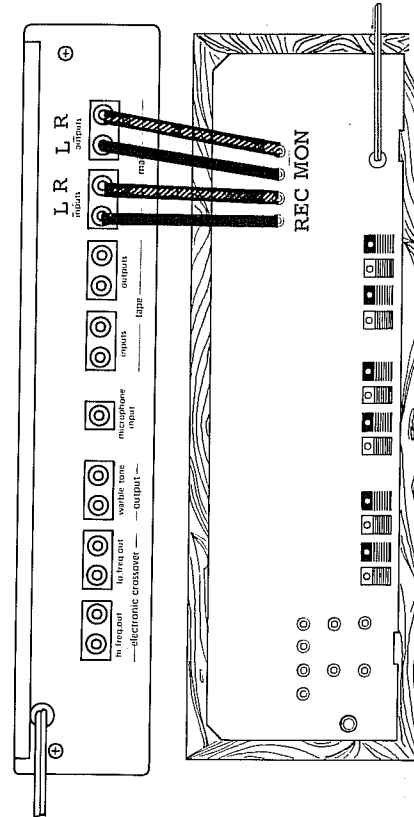

WUTS WARBLE?

What is this strange video arcade sound and how can it be used to adjust room and speaker? Basically, a warble tone is a rapidly oscillating tone of fixed amplitude with specific frequency parameters.

Well, actually that didn't sound too basic. In English, that means it's a tone that oscillates back and forth within a certain range, (in this case, one octave). It's like a little "window" of sound output. (see illustration)

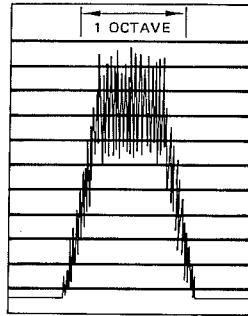

If everything goes well—no room for acoustic distortion and perfect speakers—then our ultra-flat microphone will “see” this window exactly. But if anything isn't right with the room and speakers within that octave, the “window” is distorted, the meter will droop and you'll know to compensate in that area.

One question we're asked is how does the warble tone differ from the pink noise. Well, pink noise is an entirely different test medium to fit a totally different kind of metering device: It's equal parts of each octave. In a unit like our C-101 you project pink noise from 32-16,000Hz and then look at the whole spectrum through the C-101's all-frequency “window”.

The R/S uses a dB meter which only “looks” at $\frac{1}{2}$ octave at a time. So we provide a test medium which evaluates one octave at a time.

Is it accurate?

Very. Killer scientific instrument microphone manufacturers such as B&K use warble tones to calibrate their incredibly accurate lab mikes. And our tone is very much like theirs.

In either case, though, the basic concept is still this: Put a “perfect” signal in one side; read the “imperfect” output on a perfectly flat mike, and you’ll know what imperfections are being contributed by the room acoustics and speakers.

And so on to some analysis even Woody Allen would like.

THE SOUND OF A ROOM.

Sound doesn’t just come out of your speakers and disappear into the woodwork. It bounces around. Some frequencies bounce better than others.

Mid and high frequencies, for example, are absorbed by carpets, drapes, bedding, Persian cats, nude bodies, philodendron plants and upholstered furniture. Inversely, in a bare room with hardwood floor, lightly curtained windows, and plaster walls, the highs bounce around and seem magnified to your ears. An acoustic engineer would call it *hot*.

Low frequencies tend to resonate (or bounce around rhythmically). This is why large auditoriums and even larger living rooms are so “boomy”. A certain frequency range is getting accentuated by continuing to bounce around. Not only does this make your ear think there is more of a certain frequency coming out of a speaker or off a record, it tends to muffle sounds because they’re still bouncing around when other sounds are being made. You get a sort of fatiguing BONK!!!

Here’s how to make it all better.

GETTING YOUR HOUSE IN ORDER.

Before you fiddle around with equalization, you should do everything you can to improve speaker positioning and L-pad balance.

First let's consider speaker positioning. This breaks down into two concerns, 1) high-end propagation and 2) bass propagation.

No tweeter is as good a radiator of highs as it could be. They all tend to be somewhat directional. That is, you hear more highs directly in front than you do as you move around to the side of the speaker.

Thus, you want to make sure that your speakers' tweeters are pointing directly at your listening position.

If they're on the floor, this may mean tilting them up slightly toward your listening position. If you have them up on bookshelves, make sure the tweeter is lowest and that the whole speaker isn't much higher than chest high. All this ensures that what highs your speakers do put out can get to your ears in a straight line.

Speaker placement also dramatically affects bass. Put simply, bass is increased when you put a speaker in a corner or close to the floor.

Sometimes this is good and sometimes it's bad. The type of speaker you own, how big its woofer is and what kind of music you play all have effects. Experiment around between placing speakers in corners and moving them out into the room.

If you like rock and pop music we recommend corner placement to boost bass (since you have an equalizer/analyzer you can cut down on the frequencies which get too exaggerated).

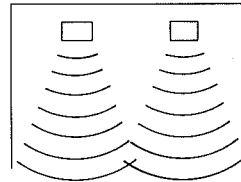

At least three feet away from corners cuts bass addition.

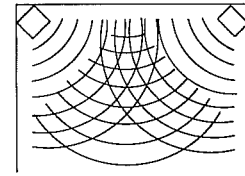

Corners act as horns to increase bass.

Whether or not to place speakers directly on the floor is also a consideration.

Some speakers tend to bounce mid-bass off the floor and out at the listener, causing sort of a doubling effect. This resonance may not be desirable.

Whether you should invest in a speaker stand which elevates the whole shebang and eliminates floor resonances can be determined with some beer or pop cans. Elevate each speaker with four of 'em and then play some music with lots of bass. If "bonkiness" is cut down without losing really low bass, stands will be a help.

Again, we philosophically tend toward increasing bass naturally with floor/corner placement as much as possible since it can always be *reduced* with the R/S. Much more efficient than boosting bass electronically.

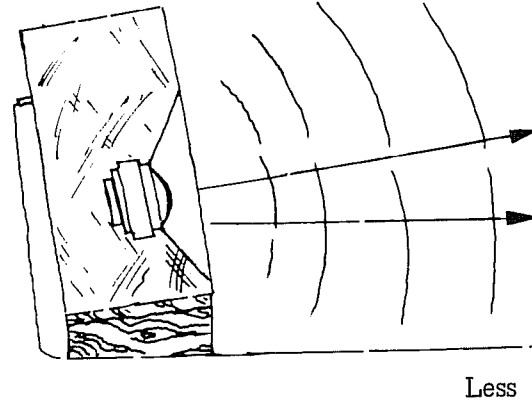
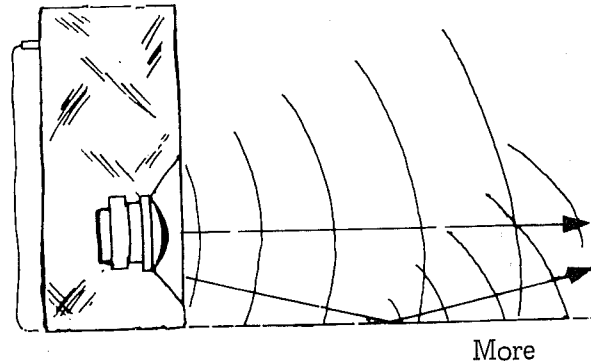

WHAT'S THE "L"?

Two and three-way speaker systems have switches or knobs (L-pads) on them to control output of the tweeter and midrange in relation to the woofer which gets to go full blast all the time.

We could tell you to "consult your speaker's owner manual" for info on this but that's a cop out because either they didn't tell you much to start with, or the instructions got buried in your closet somewhere.

Theoretically the L-pad controls were intended to help integrate the speaker with the room. But you have the R/S for that so what we suggest is you just try to get the speaker elements to "blend". That may not mean a neutral setting for the L-pad controls, though.

Tune your FM receiver between stations to get a hissing sound. Now turn down your receiver treble control all the way and turn up the bass all the way. While this is only a crude approximation of pink noise, it is a constant sound with which to adjust your speakers.

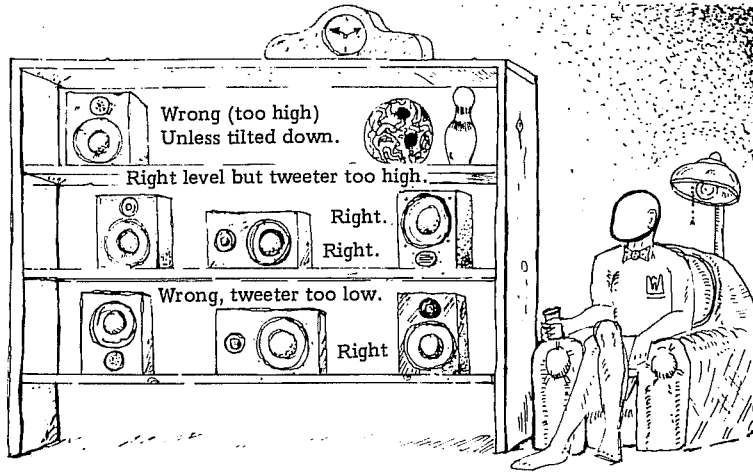

Place your ear between the tweeter and midrange on one speaker. Adjust the tweeter control until the rushing sound seems to "blend" between midrange and woofer.

Now you have your speakers and room ready for warble tone analysis.

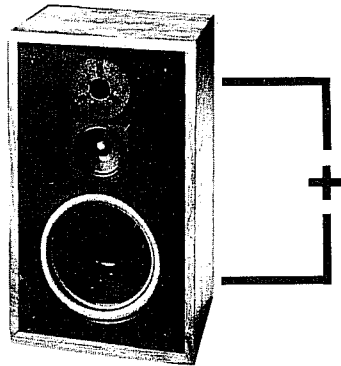

THE AUDIO CONTROL MEASUREMENT MICROPHONE.

Time to hook on the R/S's ears.

Locate the single RCA socket marked MICROPHONE on the back of the R/S. Plug the mike into it and unfurl the 20' cord.

The Audio Control laboratory microphone is a precision, non-directional, phantom-powered condenser type; designed ONLY for the measurement of acoustics. It is intended for use ONLY with the Audio Control R/S analyzer/equalizer. Do not attempt to use it for voice or music recording, or with any other phono-jack input on tape decks or amps.

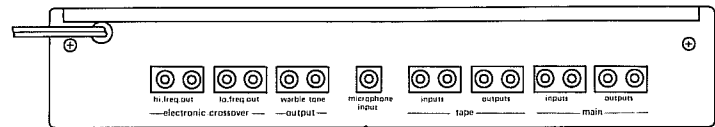

measurement microphone



Also, don't plug any other microphone into your R/S's rear phono-jack unless you are contemplating potential destruction to your mic. Condenser microphones such as the Audio Control laboratory microphone require a power supply. That's what the term "phantom-powered" refers to: A viable supply within the analyzer. So the phono plug on the Audio Control microphone is actually a mono-microphone plus a + 15 volt input. Not at all the sort of thing you would want to plug a regular mic into.

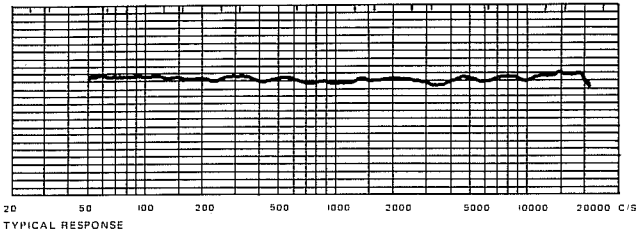

The actual microphone element exhibits a typical response that is as flat as other very expensive (\$200 and up) "laboratory" reference microphones. It is your foundation for making accurate readings with your analyzer.

Even a few years ago such a microphone would have been prohibitive in cost for the home audiophile. Luckily, high-quality condenser elements have broken through the same barrier that pocket calculators, pong games and tiny TV's have so now you possess an accurate and affordable reference microphone. Enjoy!

FOREPLAY.

1. Make sure the R/S and your amp or receiver are turned on.
2. Set the R/S's sliders at OdB and make sure that your receiver's bass, loudness, low cut, and icemaker knobs are either out or set at zero.
3. Place the Audio Control measurement microphone in your listening area with its element pointing between the speakers. If you listen sitting down, make sure the element is at the same height as your ears. You might tape it to a chair back, for instance.

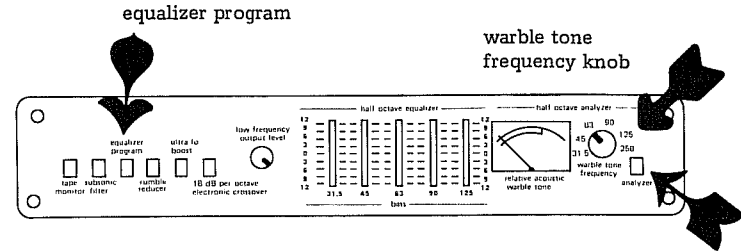
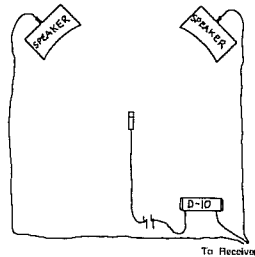

4. Push the *equalizer program* and *analyzer* buttons on the R/S.
5. Switch your receiver to AUX.
6. Set the R/S *warble tone frequency knob* to 250Hz.
7. Turn up your receiver volume control while watching the R/S meter until the needle is *actually* at zero dB.

DOING THE DEED.

1. Turn the warble tone frequency knob to 125. Watch the dB meter closely.

1A. Note the reading on the meter.

1B. Carefully adjust the 125Hz knob to 31.5, listen to the 45Hz warble a cones, howling dogs in the next block . That is, if the reading is -10, adjust the slider until it is -5. If the reading is +3, adjust the slider to get a +1½ reading. Of course if the meter says 0dB, leave the corresponding slider alone.

2. Now turn the warble tone frequency knob to 90Hz and repeat steps 1A and 1B.

3. Do the same for 63Hz and 45Hz. Each time, adjust to achieve just half of the needed boost or cut.

4. Before turning the warble tone knob to 31.5, listen to the 45Hz warble a moment. If there is a rubbing sound or audible distortion which would suggest woofer over-excursion, do not rotate the warble tone frequency knob to 31.5.

Doing so can damage small woofers which are not capable of the awesome excursions necessary to create this frequency.

4A. Ease the knob down slowly.

4B. Note the meter reading. It may very well be -20dB or even less. That's because most woofers just can't put out this frequency.

4C. SLOWLY advance the 31.5 slider, listening for any signs of woofer overdrive (flames, ripped cones, howling dogs in the next block) If necessary, advance it all the way to +12 even if this does not achieve the correct amount of adjustment.

4D. (For owners of woofers which make funny sounds when warbled at 31.5.) Don't feel bad, if you can flatten the woofers to 45Hz, that's better than most systems anyway. Add as much 31.5 as you can and then back off slightly, since the 45Hz slider will soon be re-adjusted to compensate.

5. Now rotate the warble tone frequency knob back to 125 and repeat steps 1-4. This is necessary because of filter interactions between each of the half-octave bands: adjusting one affects the bands adjacent.

6. If necessary, repeat the sweep again.

The object is to be able to sweep the warble tone frequency knob and not have the meter deviate from 0dB until it gets to 31.5 where, as we have explained, not all, (try "very few") woofers can put out flat response.

Now you have calibrated the system and are ready to learn the awful truth about your speakers' room acoustics, and low bass response.

WHAT HAVE I DONE?

Sit back and look at the curve made by the R/S sliders.

The amount that the curve deviates from 0dB is how far from "flat" your room and speakers were making the sound.

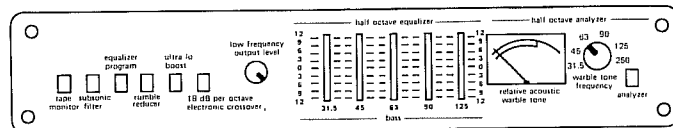
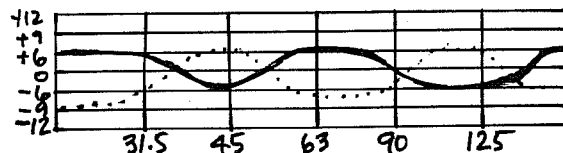

We've included some blank charts in the back which you can use to draw the curve if you'd like to compare it to others. Just plot the values backwards. That is, plot +4dB as -4dB, etc. What you now have is a plot of your speakers in your room. Doesn't look much like the one in the owner's manual, literature or magazine review does it?

REPEAT WHEN NECESSARY.

When's necessary?

Re-analyze whenever you 1) move your speakers, 2) re-adjust your L-pad controls 3) get new speakers 4) drastically change your room acoustics 5) bi-amp or add a subwoofer.

One drastic EQ change is when you fill a room full of people. If you could ever get a whole room full of partying people to stand around while you warbled at them, you'd find a BIG change. Bodies drink up mids and highs quickly.

A room full of full-grown wombats is particularly nasty in this respect. Compensate by never inviting more than three marsupials to any one party.

BI-AMPING AND SUBWOOFING WITH THE RICHTER SCALE.

The Richter Scale is a remarkable tool for realizing maximum accurate bass output from virtually any system. Part of its usefulness of course, is simply being able to accurately analyze and equalize the last three octaves of the audio spectrum.

But another important part lies in applications of the Richter Scale's electronic crossover. Since electronic crossovers have only recently been introduced to consumer electronics, we've decided to start at the beginning and lay the whole voyage out for you.

WUTS A CROSSOVER?

A crossover is a circuit that "assigns" different frequency ranges to different speaker drivers. Low frequencies are routed to the woofer to produce bass; midrange goes to the midrange, highs to the tweeter.

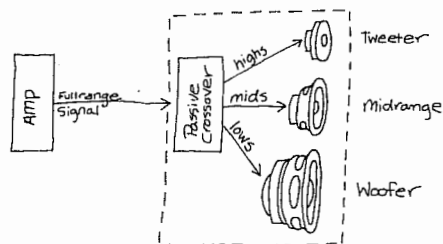

How the passive crossover distributes frequencies.

Crossovers can either be *passive* or *active*. Right now, inside your speakers are *passive* crossovers. They're composed of coils of wire, capacitors and resistors all futzed around so that when a full-spectrum high power signal zips down the speaker wire, it gets "split up" or assigned through separate internal wires to each driver.

It's passive in that it simply processes the signal which goes through it without amplification or anything. (Afterall, it has no power supply or any of that stuff and the signal is strong since it's from the amp output.)

FULL RANGE SPEAKERS PLUS A SUBWOOFER.

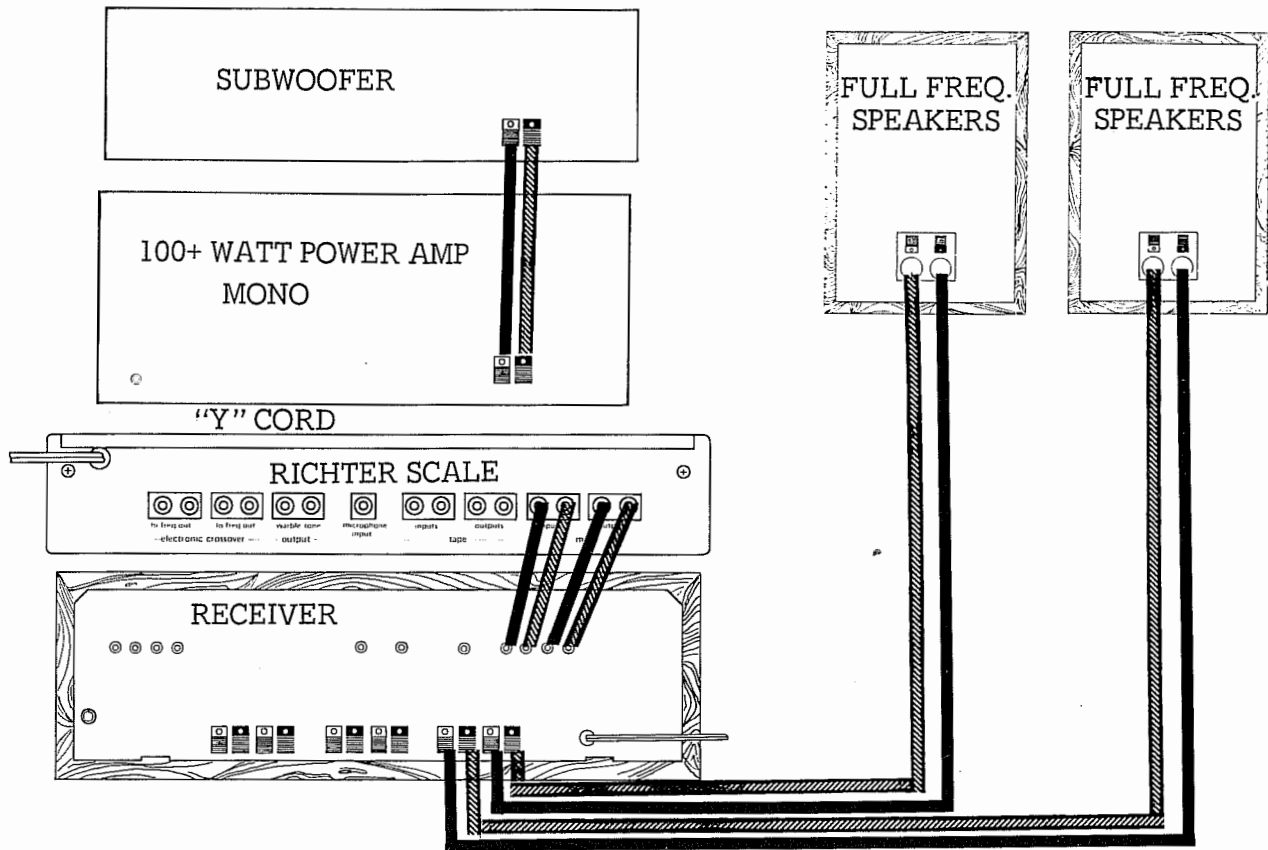

THE GOOD, THE BAD AND THE UGLY.

There are passive crossovers and there are passive crossovers. Some do an excellent job of assigning frequencies and some induce mucho distortion. Small or poor quality capacitors, undersized coils which saturate, or simply not enough circuitry are all commonly found faults in speaker crossovers. The result can be lack of proper phasing,

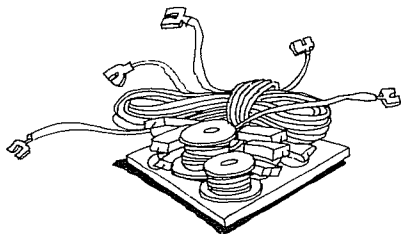

A common passive crossover (crossoverus distortus)

smearred imaging, bumps and dips in the system's response and just plain inefficiency. As much as 20% of the amp's power can be lost to a crossover, especially in multi-element systems. (Also included in this paper is a very technical article which delves into these problems in depth. If you can slog through it, you'll see exactly what passive crossover designers face.)

THE ACTIVE CROSSOVER.

There is another way to assign frequencies to the respective speaker drivers. Instead of sending one signal from amp to speakers and letting the speaker's passive crossover split up, it's possible to ELECTRONICALLY split the low power line level signal up into two or more parts, run it through SEPARATE amplifiers and directly to the respective drivers. This is

SUBWOOFER PLUS SPEAKERS FROM 100Hz UP.

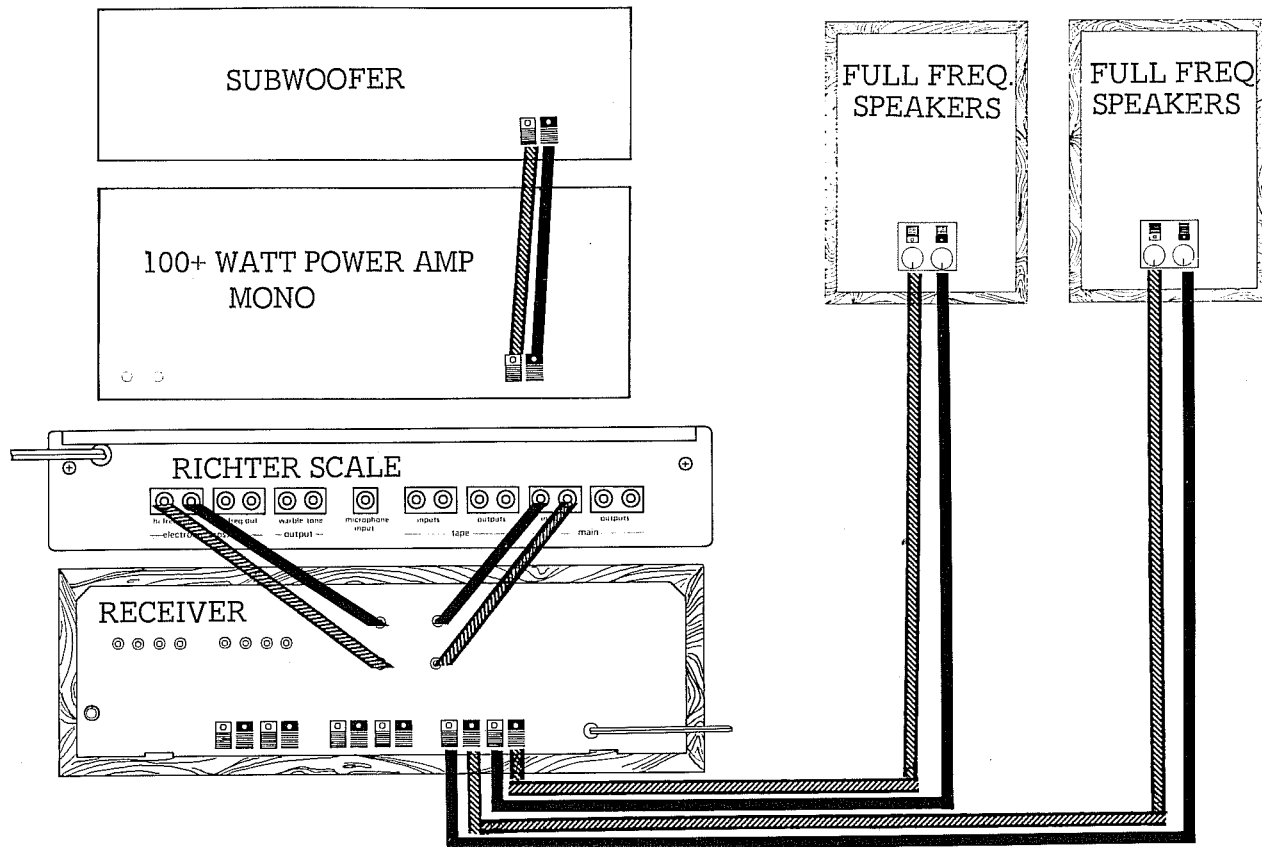

BI AMPLIFICATION USING TWO POWER AMPS.

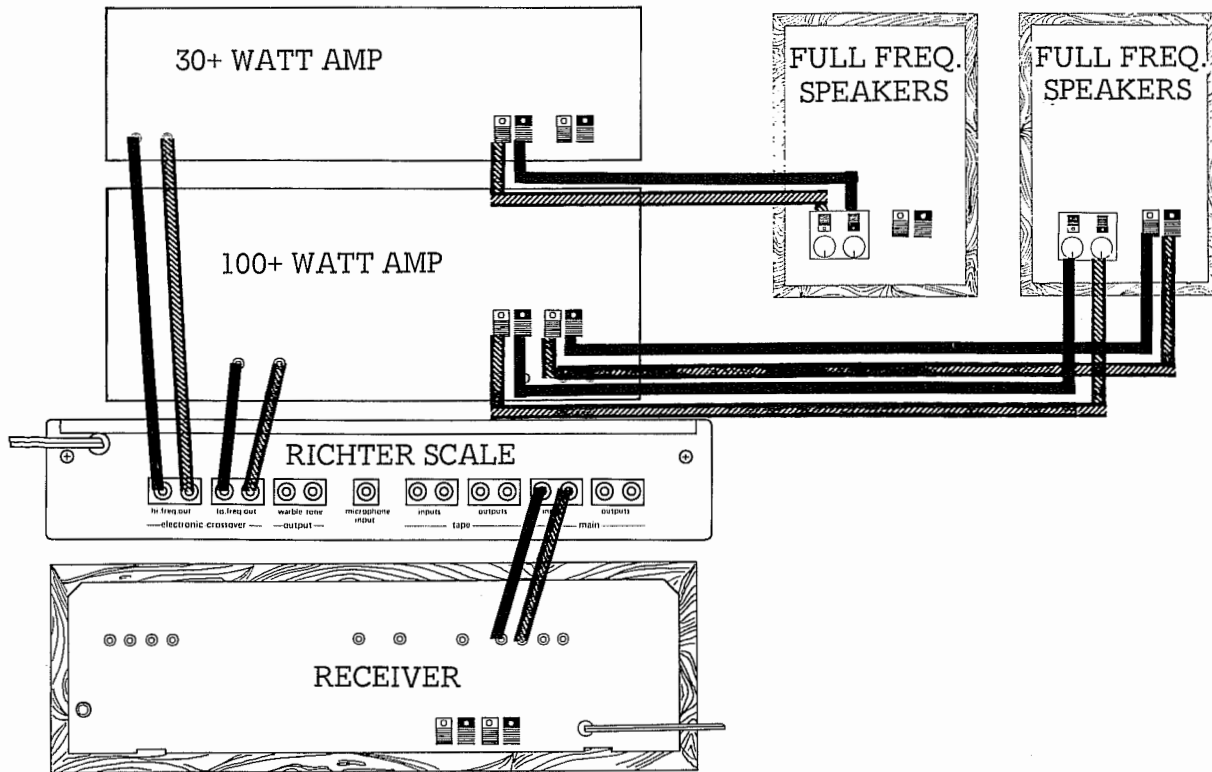

BI-AMPLIFICATION USING ONE POWER AMP AND POWER SECTION OF RECEIVER.

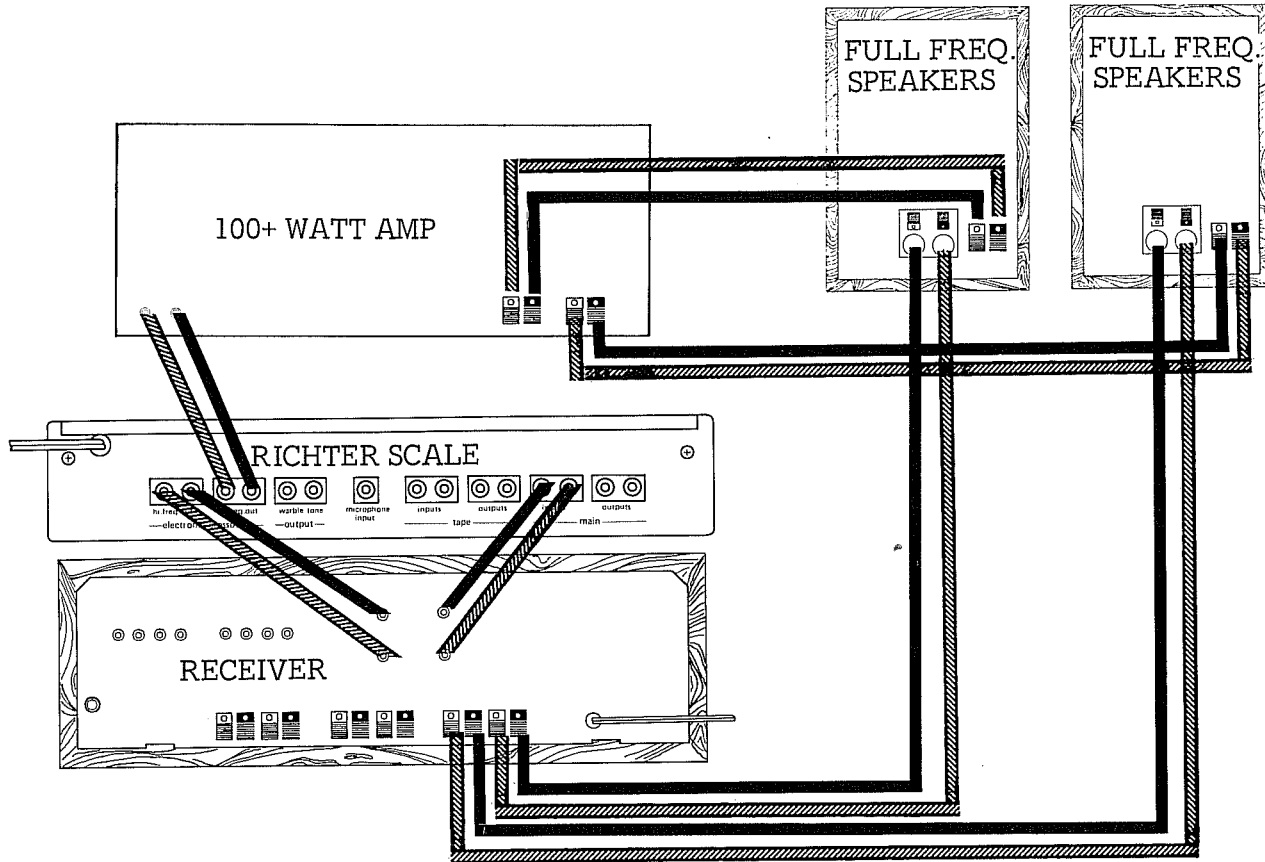

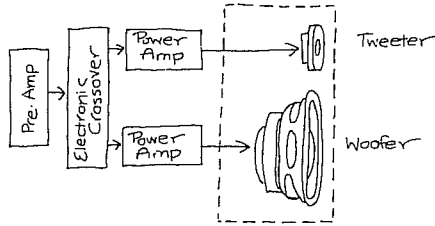

How an electronic x-over eliminates the passive x-over.

called BI-amplification, or TRI-amplification. (There are even 4-way systems. . . QUAD-amplification?)

Eeek!, you say, now I need two amplifiers and lots more wire. . . woe is me pocketbook. True, but further on we'll try to give you some honest and objective reasons why this might be a good way for you to go anyway.

In the meantime, let's consider a special kind of bi-amplification which can improve virtually *any* speaker system.

WOOFING AND SUB-WOOFING.

Woofers rarely cover that last 1½ octaves of bass adequately. Sorry kiddo, no matter WHAT the manufacturer sez, under about 60Hz, it's tough meat. Unless you have large, expensive speakers with gigundo woofers, you're losing ultra-low bass down here. And in the range from 20-35 Hz, virtually NO speakers really stay flat in actual room listening circumstances.

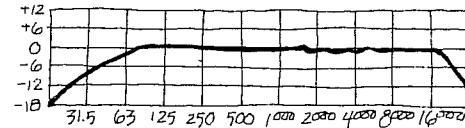

That's because a speaker whose response is reasonably flat down to say 40 Hz, would have to have its volume increased by a **FACTOR OF FOUR** to grab that last 20 Hz of bass.

This problem has become more widespread in recent years with the popularity of "mini-monitor"-type speakers which have "woofers" under 6" in diameter. Real toy poodle woofers if you ask us.

Undeniably, many of these designs produce superb imaging, good response in the high end, nice transients and a compact size which fits into decor more harmoniously. But the little devils just don't put it out under 100 Hz.

Short of renting a huge rock PA (which has its own problems) the most logical solution is to bring in a third speaker system which specializes in reproducing ONLY super low bass.

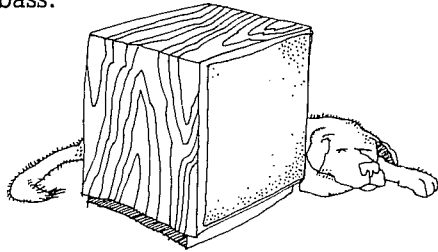

A common subwoofer (subwooferus kickbuttae).

A subwoofer!

Does that mean you have to have a huge box stuck in front of your listening area? Nope.

THE EVERY WHICH WAY SYNDROME.

Luckily, low bass is essentially non-directional. (That's why the Richter Scale can have a bass mono-ing Rumble Reduction circuit). This non-directionality means that it is impossible for the ear to pinpoint the source of ultra-low bass, especially in the reverberant environment of a living room. You *think* you can pick out the source of a drum or bass guitar, but what you're noticing is the midrange transient thump or twang and not the low fundamental.

Thus the subwoofer can be at one side or the other or even behind the listener. It can masquerade as a coffee table, or end table or skulk behind the potted palm. Or hide in a wall.

Here are some common subwoofer types. Most are intended to blend into a living room decor.

WUTS THE DIFF?

A good subwoofer is not audibly noticeable – until you turn it off. Then you realize just how much really low bass information there is to feel. . . And FEEL is exactly the word for it. It's a "base", a "floor" which you more FEEL than HEAR. Chest-thumping, gutrocking, pant-flapping, nic-nac shaking bass.

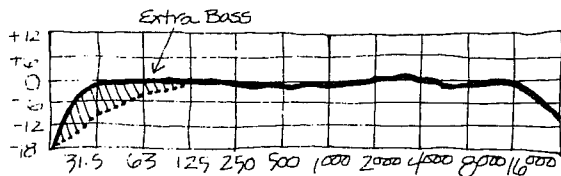

You'll really notice this extra 2½ octaves of bass!

If you're into classical music, you notice the increase in bass only occasionally. But in just the right spots: A low organ pedal note, a grumbling bass violin, or a crashing, sudden crescendo.

If you're a fancier of the new digital records, you REALLY know what we mean. The 1812 Overture cannon shots and Holst Suite in F bass drum notes are perfect examples of when a subwoofer will suddenly be called on to add those lost low sonic octaves.

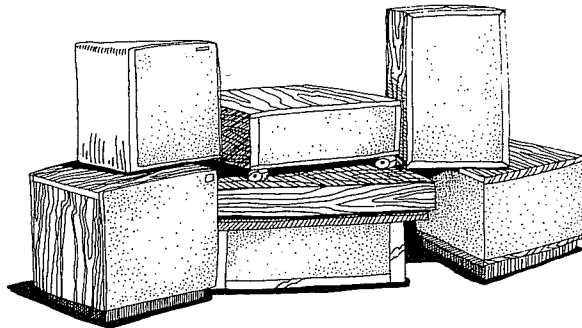

Subwoofers come in all shapes and sizes.

Another remarkable addition which classical lovers will notice is improved ambience, the background of reflected sounds. In a big hall this occurs most at super-low frequencies. Those records which have been recorded well enough to capture it, contribute considerably to the sense of a real reverberant hall environment.

As for rock, well. . . name your artist and we'll show you low bass just begging to thunder out of those grooves. Synthesizers which can run right down to below audibility. Kick drums. Fender Basses. Pink Floyd's wild sound effects. Disco. Jaco Pastorius' bass slides.

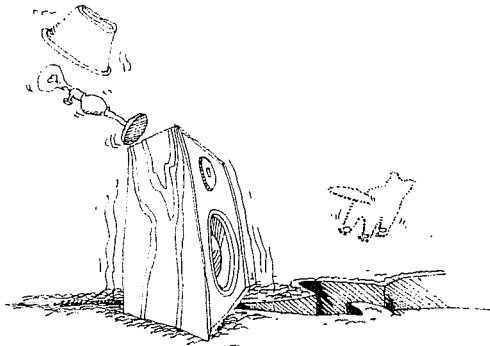

HOWZIT WORK?

Inside the subwoofer is one to four woofers in either an acoustic suspension or reflex-type box.

The signal goes from the pre-amp to an electronic crossover which splits the frequencies before routing to separate power amps.

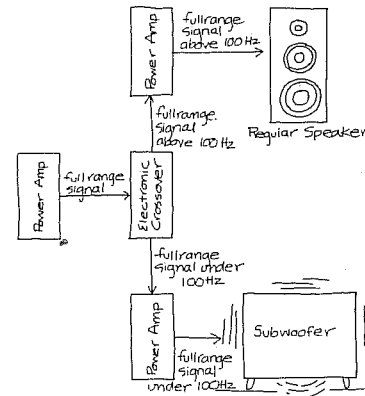

Subwoofer system uses Richter Scale, additional amp and subwoofer to gain mucho extra bass.

Previously, you had to purchase what, for all purposes, was a “professional” electronic crossover to make such a system work.

We’re not putting them down, but they weren’t attractive to audiophiles because 1) many were mono and you needed two to run a stereo system, 2) they were designed with professional cosmetics, real plugs and controls, 3) since they were for pro road sound reinforcement, they cost big bucks—usually over \$300 and as much as \$600, 4) some did not measure up to the discriminating audiophile standards of distortion, phase coherency and signal-to-noise. Thus the nifty bi-amp approach, languished in the hands of sound reinforcement systems where max sound without burn-out was a necessity.

HERE COMES THE COMMERCIAL.

That’s why we invented the RICHTER SCALE to get a good affordable electronics crossover system into more audiophiles’ homes.

To do that, we compromised nothing electronically, but we did remove a few controls. Most electronic crossovers let you infinitely adjust the crossover point. That’s important if you’re designing the Grateful Dead’s new road system, but virtually *all* sub-woofers cross over at 100Hz. So we pre-set this. (If you bi-amp, most 3-way systems crossover at 800, so that’s the other preset. See “Turning Bi” farther on.)

The amount of low bass floor contributed by the subwoofer is controlled by the RICHTER SCALE Low Frequency Output.

In pop, this delicious frequency range gets lost starting right back at the recording studio microphone. Then the tape and recorder knock off a few dB. The translation onto vinyl knocks off much dB and the playback system from the cartridge which might not go down real low to the speakers we already made you feel insecure about earlier.

Here, the subwoofer, used in conjunction with the Richter Scale's ultra-low bass boost, simply puts back what the whole signal chain has lost. You're in the control room or right in front of the PA at a concert.

Getting kicked.

And you'll love every minute of it.

Now, one big hassle with installing a subwoofer was getting it to sonically "fit in" with the existing system. The sound is so low, you can't blend it instantly by ear. Most subwoofer manufacturers wring their hands over this one. The hi-fi mags suggest you rent, buy or borrow an analyzer. . . but when you own the Richter Scale you already have one!

After hooking in the subwoofer, just warble-tone analyze, using the dB meter and Audio Control Measurement microphone. Now there's no trouble integrating even a home made subwoofer into any system.

DOING IT YOURSELF.

A subwoofer is one of the easiest speaker projects to build.

Considering the store-bought ones can cost \$200–\$600, your wallet might be able to put up with a little sawdust to shave the cost to around \$75.

A number of mail order companies sell suitable, 10", 12", and 15" drivers and in large cities do-it-yourselfer audio shops can provide drivers and inspiration.

Don't get sidetracked into expensive professional sound reinforcement or music woofers. You don't need this extra, expensive durability.

Plans for subwoofers often appear in *SPEAKER BUILDER MAGAZINE*, a neat little pub which is a must if you're into do-it-yourself sound.

The plan we recommend is a good all-around model using easy-to-find drivers. It was designed by an engineer at Speakerlab Inc. world's largest manufacturer of speaker kits. You can write them for a catalog at 735 Northlake North, Seattle, WA 98103. Neither the designer or Audio Control implies any performance guarantees or liability if you blow up your system or whack your finger off with your Black & Decker while building this design.

QUICKIE "STOMP-EVER" SUBWOOFER PLAN FOR 15" WOOFERS
 USING 1-SHEET 1" PARTICLE BOARD & ACOUSTIC FIBERGLASS.

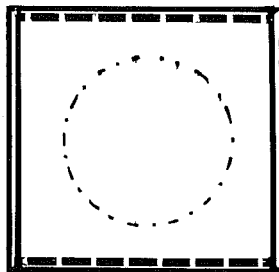
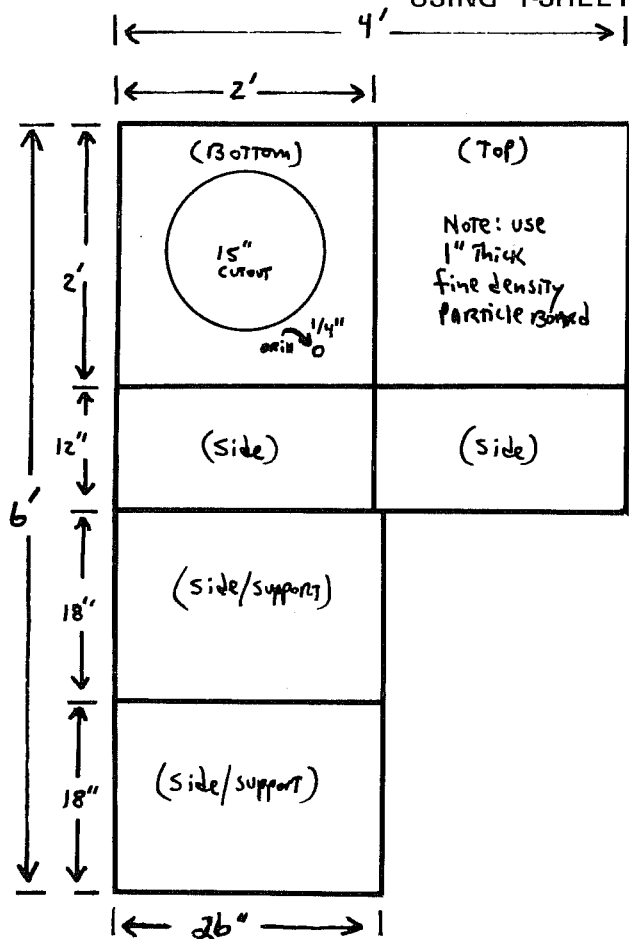

1. use 1" fine particle board.
2. Glue All edges with white glue
3. Line with min. 1" Thick Acoustic fiberglass.
4. Point "open" side into room.

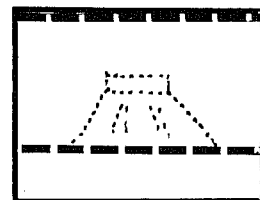
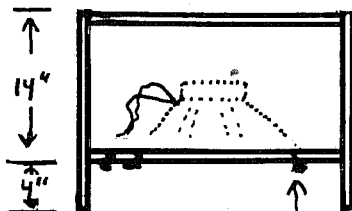

MORE REASONS.

We've raved about the extra bass effect possible with a subwoofer and it's really true. Definitely worth the cost of a subwoofer and extra power amp.

But you should also consider the sonic improvements in your *existing* system. Both bi-amping and sub-woofing significantly improve *woofer damping* which makes for tighter, crisper transient response.

Once your amplifier gets a woofer moving, it has to electronically apply "brakes" to get it to stop. Optimally, the mechanical driver should start and stop exactly when the signal starts and stops, how well it does that depends on the amplifier's design.

But NO amp needs the added aggravation of a passive crossover. To continue our brake analogy, a crossover is like a spongy rubber brake system. When the amp applies the brakes, there's a squishy instant when the woofer keeps going as the signal sloshes

around inside all those coils and capacitors. The result is a sloppiness of bass.

By employing a separate bass amplifier, sub-woofing (which frees low-end bass from this problem) or bi-amping (which frees the entire bass section) dramatically improves damping. You have about as optimal a system as anybody has devised: nothing but a straight wire from amp to speaker.

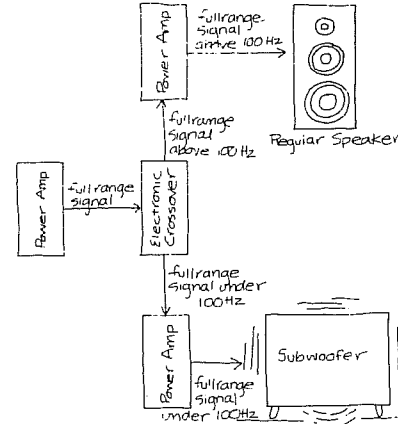

Subwoofer system uses Richter Scale, additional amp and subwoofer to gain mucho extra bass.

HOW TO KEEP FROM GETTING CLIPPED.

Here's another benefit of bi-amping and subwoofing. Freedom from clipping.

What is clipping? First, you have to understand that how much power a driver consumes is proportional to how far its mechanical parts have to travel. A ribbon tweeter moves a few THOUSANDTHS of an inch and requires only a few watts. A woofer may move up to HALF AN INCH, shoving a massive column of air. It's no wonder it can consume up to 80% of your amp's power.

That's fine as long as you have a mondo amplifier with lots of spare power (headroom). But what if you're pounding hard rock out of a pair of 12" 3-way speakers with a 30 watt amp? When you crank it up super high, the amp suddenly needs peaks many hundreds of watts which it can't put

out. So instead of a bass note looking graphically like this... it looks like this.

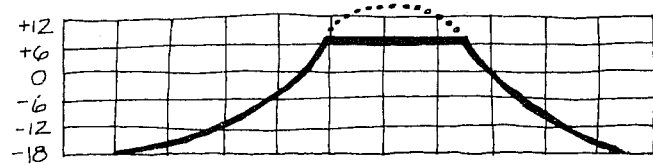
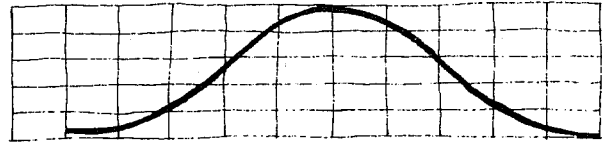

Amp takes best shot at reproducing waveform. When it can't, it caps out and "clips" the part it can't reproduce.

The top is “clipped” off at the point where the amp runs out of juice. If that was all the problem, you’d just have distorted bass at high sound levels. But electronically, something else happens inside the amp, too. A little burst of *super-high* frequency energy is emitted, a sort of electronic squeal of anguish. That travels down the wire, too. And the passive crossover dumbly routes it to the tweeter which disappears in a puff of smoke.

This is a hard concept for most people to grasp: that under-powering speakers causes burn-out more often than over-powering them. But just ask any speaker repair center why they have to replace so many tweeters. Or try it yourself. You don’t even have to be a Led Zepplin fan. Just try a digital classical recording with massive low bass transients.

Now, you could simply buy a gigantic amp. But you’re still dealing with those problems we outlined earlier: passive crossover distortion, crossover inefficiency, ringing, and reduced damping.

TURNING BI.

The solution is to completely separate bass from midrange and/or treble. Two amps, two sets of wire to the speaker. Bi-amplification.

Listening tests have demonstrated that bi-amped systems have audibly lower distortion. 1) There are no passive crossover problems, 2) you can play them louder without driver damage, 3) damping is improved, 4) you can actually operate the

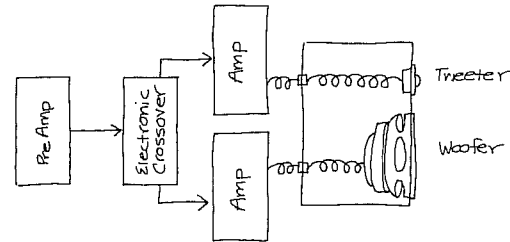

system into low-end clipping without audible distortion.

You see, low end “clipping” and distortion is not particularly noticeable. Your ears are most sensitive to high-end - distortion components above 1000 Hz.

Thus you can crank up a hot cut and drive the bass and drums mercilessly loud (and into inaudible distortion) without causing any *audible* distortion in the vocals and higher instruments.

How do you bi-amp? If you’re designing a system or building a kit, then you simply leave out some parts. If you already have a good system, then you’re looking at a bit of remodeling.

It’s not a long job but you may want to get the help of your Audio Control dealer. He may be willing to remove the woofer, clip its leads from the crossover and run new wires from the woofers to a second set of terminals.

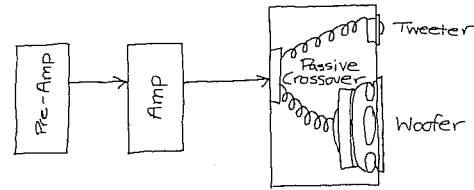

Old fashioned hook-up leaving listener at mercy of cheapoid passive crossover.

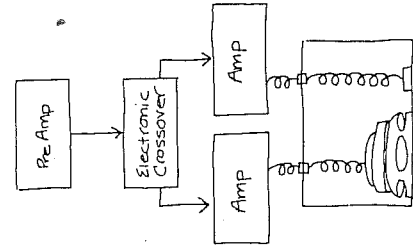

State-of-the-art bi-amping replaces passive crossover with electronics and separate amplifiers.

Now you have a set of speakers with two sets of terminals on the back.

The crossover is still used to split mid and highs in a three-way passive system. If you've modified a two-way system, you can, of course, totally scrap the passive crossover. Pure straight wire!

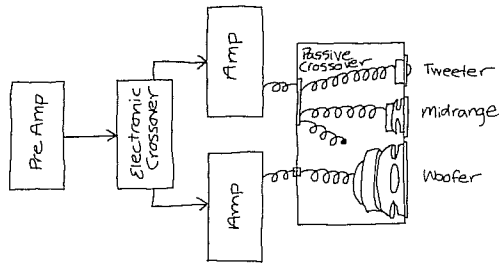

Bi-amping with three-way speakers. The passive crossover is used to distribute midrange and highs. The low-end wires from x-over to driver are by-passed.

Don't be afraid of this slight modification. Think of it as removing an unwanted growth inside your speakers.

And of course we provide full surgical instructions in the RICHTER SCALE manual.

Since virtually ALL popular three-way systems cross bass over with midrange at around 800 Hz, that's what we built into the RICHTER SCALE. Yet if you have a two-way system or something wierd with a different crossover frequency, your dealer can change your RICHTER SCALE with just a few simple parts substitutions. Mix and Match.

Running two amps opens up some fascinating possibilities.

One of these amps can be relatively low power. As low as 40 watts per channel. Of course the other needs to be a brute: nothing less than 100 watts per channel is recommended.

That goes back to the relative needs of the different drivers. The woofer needs lots of power. The tweeter and midrange much, much less.

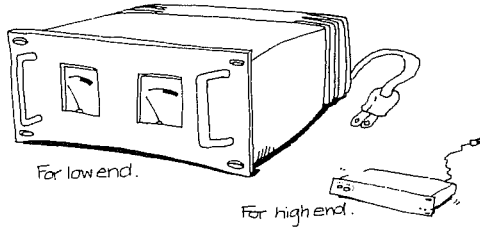

Comparison of gigantic low-end amp with petite high-end amp. On the left: the Acme Heavy Equipment Blortophonic 5000 Industrial Arc Welding Amplifier. On the right: The Prissy Products Ultra-Tweakoid Super Conducting Field Effect Tube Golden Ear 25.

You could, for example select a low-powered but super-spec integrated amplifier to provide the 30 watts needed for high end. You can take advantage of all the new negative feed back, DC coupled, FET technologies without having to pop for a big bucks power version. The bottom can be run with just a plain, industrial-strength, no-frills amp like the BGW 110 or 210, Apt 1, Carver M-400, Crown PL1, Hafler DH200K, Nikko 220, Phase 300, Adcom, Technics 9060 etc. Remember, you're looking for *mono* power, so an amp which is switchable to 2X power in mono (strappable) is just fine. in mono (strappable) is just fine.

And, since you're not worried about *full-range* distortion, you can consider a whole range of professional amps with hefty output at slightly higher THD.

In fact, the amp doesn't even need a volume control. That's why we put one on the Richter Scale. You just hook things up like this.

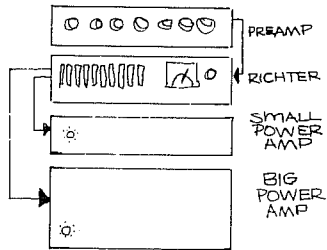

Standard bi-amp approach using two power amps, pre-amp and Richter Scale.

What if you have a receiver you really like the sound of? Bi-amping doesn't mean you have to scrap it. Just use it for the high end and pre-amp and get another power amp. A variation for receivers with higher wattages (80-120 watts/chan) uses their output for the low end and a modest 20-30 watt amp for the highs.

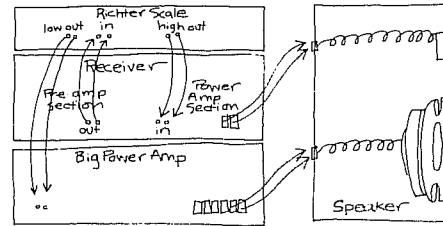

Hook-up using the tuner/pre-amp and amp parts of a receiver separately. Signal goes from pre-out to Richter Scale. Then the power part of the receiver is used as a clean high-end amp in the bi-amp system. This way you only have to buy one more amp.

Anything is possible just so there is sufficient power for the low end. Two identical amps may be used, although one will loaf along and the other will work harder.

You could use a super-tweak tube amp for the high-end where a difference would be heard and a really "dirty" professional power amp for the low end. . . and still have a better sounding system than if you just used one amp.

WHICH IS BETTER, SUBWOOFING OR BI-AMPING?

There's no easy answer to this one.

One way to answer it would be to consider your present system. If you have twelve or fifteen inch woofers, then bi-amping can get more out of your existing woofers. An add-on subwoofer definitely beefs up speakers with 6'', 8'' or even 10'' woofers.

This question could also be answered from the standpoint of musical lifestyle. Not only *what* do you listen to, but at *what level* do you like to hear it?

If you have a taste for really cranking your music, bi-amplification (in conjunction with stout woofers) can give you a quantum leap in volume and low-end while protecting your tweeters and amps.

But it won't capture that low octave of bass the way a subwoofer will.

This writer personally likes shock-volume music. After frying innumerable systems, I have gone to 15" woofers and a bi-amp system with 180 watts per channel on the low end and 70 watts on the top.

This system kicks, but it doesn't go as low as a friend's system which uses 6" woofers in small monitor-type speakers and a 15" subwoofer. He plays his music quieter, but really likes that unobtrusive "floor" which the subwoofer brings to all types of music.

Both of us can play Telarc digital records and master tapes without fear of amp or tweeter burn-out, although his system begins to distort, at lower sound levels than mine.

Both systems sound worlds better than ANY single-amp system we've ever heard. Friends describe the RICHTER SCALE systems as "tight", "crisp", "uncolored". His approach shakes them; mine blows them away. Both systems are free from distortion.

And both were worth the hassle and additional bucks.

My friend's RICHTER SCALE, extra 100-watt amp and subwoofer cost LESS than the huge power amp he was going to get in the mistaken impression that it would give him more low end reserves..

My RICHTER SCALE, amp and 69 cents worth of wire and terminals saved me a fried system AND my ears which cringe at high-volume high-end distortion just like anyone else's.

The decision is up to you. You might consult Peter Mitchel's article called "Subwoofers" in the October 1979 Stereo Review, Victor Campos' piece in the October 1979 High Fidelity or the series on bi-amping which ran in the fall 1980 issues of Modern Recording.

Or ask your dealer.

Or, as a last resort, call us rain-forest rowdies up here and ask for Customer Service. No collect calls, though.

ASYMMETRY UNLEASHED.

Time to trot out a couple charts now, folks. Face the blackboard please. This is a chart of a 6 dB per octave three-way crossover system. Note the “shaded” areas.

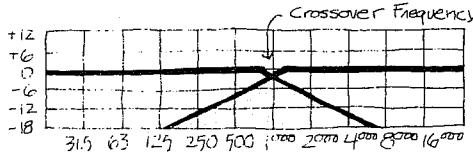
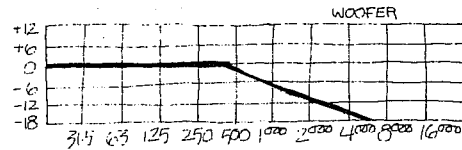
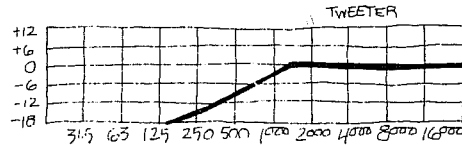

- A. 6dB/octave tweeter range in a 2-way system.
 B. 6dB/octave woofer range. C. Note overlap.

It would be nice if a driver could simply cut off exactly at the end of its assigned frequency, but from a psychoacoustic sound standpoint, there *has* to be some overlap. In this case, the midrange still puts out diminishing amounts of sound as low as 250 Hz though it's 12 dB down at that point.

Conversely, the woofer is allowed to play as high as 4000 Hz. Overlap this far is common in real cheap systems but, due to the low cost of such a cheapie crossover, more expensive systems are concerned with not forcing the midrange or tweeter to go as low and risking possible burn-out.

Thus the common 12 dB/octave passive crossover system as indicated below. The slopes are sharper, cutting each driver off more rapidly.

Unfortunately, even the best of these systems suffers from inherent fundamental problems we're only now beginning to understand. They have to do with phase.

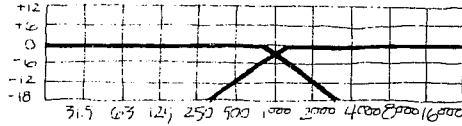

Common 12dB/octave crossover used in active and passive systems.

Each driver has to work exactly at the same instant as it's neighbors. The more drivers you use in a system, (and the minute you go for stereo with two speaker systems) the more chance that one driver will get half a cycle off and cause cancellation. This is the gist of the AES article by Professor Leach which we have re-printed.

Leach *did* discover one breed of crossover which is almost phase-perfect, though. It happens to be an asymmetrical design. That is, the slopes of the woofer and midrange are different.

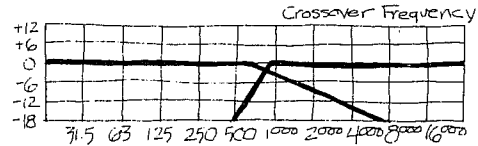
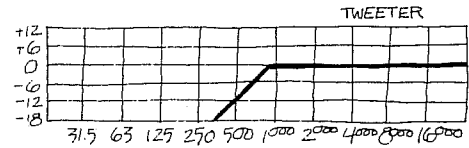
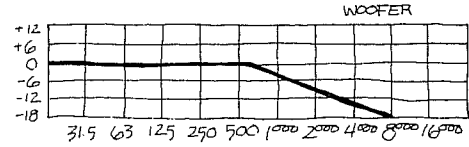

- A. "Shallow" 6dB/octave woofer roll-off runs quite high for smooth overlap.
- B. 18dB/octave tweeter cut-off protects tweeter and eliminates area where it doesn't perform well. A woofer can play high but a tweeter can't play low: How many 1" woofers have you seen lately?
- C. Product of asymmetrical x-over.

As you can see, the woofer is allowed to play fairly high through a 6 dB 6 octave filter. There is, of course no danger to the woofer no matter how high it plays.

But the high-end gets abruptly and sharply lopped off at 18 dB per octave.

All we can say is that this system's design sounds very good, just like the good professor said it would, and should effectively herald a new era of consumer bi-amping.

When used with a subwoofer, the 6 dB slope lets a fair amount of midrange into the subwoofer. That means the subwoofer should be positioned between the two stereo speakers. If this is inconvenient, a single capacitor in the speaker connection will increase the slope of the RICHTER SCALE crossover sharply enough to eliminate this effect.

RICHTER SCALE FLOW CHART

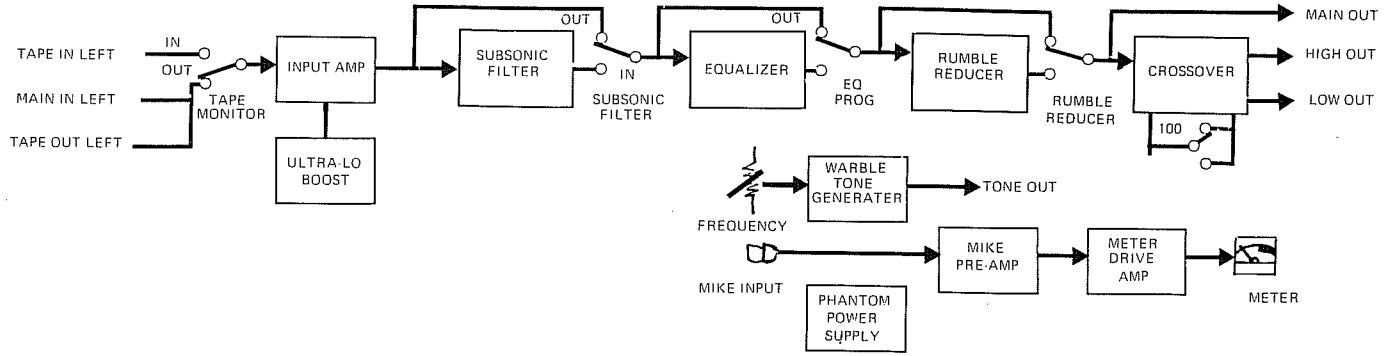
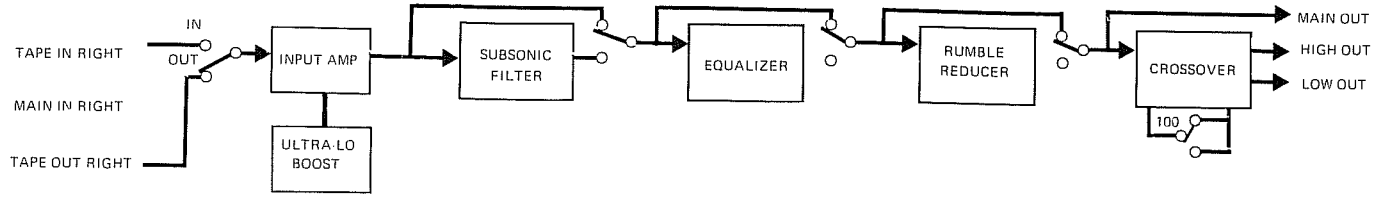

INTRODUCTION TO THE AUDIO CONTROL CONDITIONAL WARRANTY.

People are scared of warranties. Lots of fine print. Lots of non-cooperation. Months of waiting around.

Well, don't be scared of this warranty. It's designed to make you rave about us to your friends. It's a warranty that looks out for you and helps you resist the temptation to have your friend "who's good with electronics" try to repair your Audio Control product.

Also, warranties help us keep track of our customers so we can let you know of any modifications, dangers, or improvement. The old factory recall thing. Now, that doesn't mean you are going to get put on a mailing list, and get wierd Aztec porno or free deodorant samples. Your name and address on the warranty are strictly confidential to Audio Control.

So, go ahead and read through your warranty, then enjoy your equalizer for a few days before sending in the warranty and any comments.

CONDITIONAL WARRANTY.

"Conditional" doesn't mean anything ominous.

The Federal Trade Commission makes all manufacturers use the term to indicate certain conditions you have to meet before they'll honor the warranty.

If you honor these conditions, we will warrant all materials and workmanship on your Audio Control product for one year from the date you bought it, and will fix it or replace it during that time.

Here are the conditions that make this warranty conditional:

1. You have to fill out the warranty card and send it to us within 15 days after you have bought your Audio Control product.

2. You must keep your sales slip or receipt so you have proof of when, and from whom, you bought your **RICHTER SCALE**. We're not the only company to require this, so it's a good habit to get into with any hi-fi purchase.

3. Your Audio Control **RICHTER SCALE** has to have been originally purchased from an authorized Audio Control dealer. You don't have to be the original owner to take advantage of the two-year warranty, but the date of purchase is still important so be sure you get the sales slip from the original owner.

4. You can't let anybody but someone, at our factory, nurse your ailing unit back to life. If anyone other than us messes with it, that voids the warranty.

5. The warranty's also not in effect if the serial number has been altered or removed, or if the Audio Control unit is used improperly. Now that sounds like a big loophole, but here's all we mean. Unwarranted abuse is: a) physical damage, (our consumer products are not meant to prop up bookcases or get hauled around in a toolcase, etc. The Richter Scale is a home hi-fi unit, not a bash-it-about utility equalizer so if you bash one up, we can't be responsible. b) improper connection, patch the phono jacks into a line socket or hook it to the speaker terminals on your power amp and we aren't responsible... high input signals could fry the innards, c) sadistic things you shouldn't do to any electronics, such as get them too hot, wet, dirty, etc.

Assuming you conform to nos. 1-4 and it's not all that hard, we get the option of deciding whether to fix your old unit or give you a new one. This is the only warranty given by Audio Control. This warranty gives you specific legal rights which vary from state to state. Promises of how well your Audio Control product will work are not implied by this warranty. Other than what we've covered in this warranty, we have no obligation, express or implied. Also, we will not be obligated for direct or indirect consequential damage caused by defect or warranty claim, express or implied, or damage to your system caused by hooking up the Audio Control Richter Scale.

Failure to send in the properly completed warranty negates any service claims.

WHAT TO DO IF YOU NEED SERVICE.

Take it back to the store you bought it at. Then he gets to hassle sending it back.

If you get any flack from the dealer after you've conformed to 1-4, call us and we'll have words with the dealer.

Unfortunately, you may have bought it mail order or moved to another city or the dealer disappeared one day into Chapter 11.

In that case, contact Audio Control. In writing at 6520 212th S.W., Lynnwood, Wa. 98036, (Attn: Service Department). Or by phone at (206) 775-8461. No collect calls.

Make arrangements to have the unit sent back to the factory for service.

In either case, proof of purchase must be included with the unit. (That sales slip or receipt we've been harping about.) And a brief note telling us what's been wrong with the unit. (You'd be surprised how many folks forget to do this.)

The normal service time at the factory is less than three days.

If you can't get it back to the dealer, you're responsible for freight or postage when sending it to the factory. Actually, we recommend UPS emphatically over the Pony Express Postal Service. It's more reliable and faster, too.

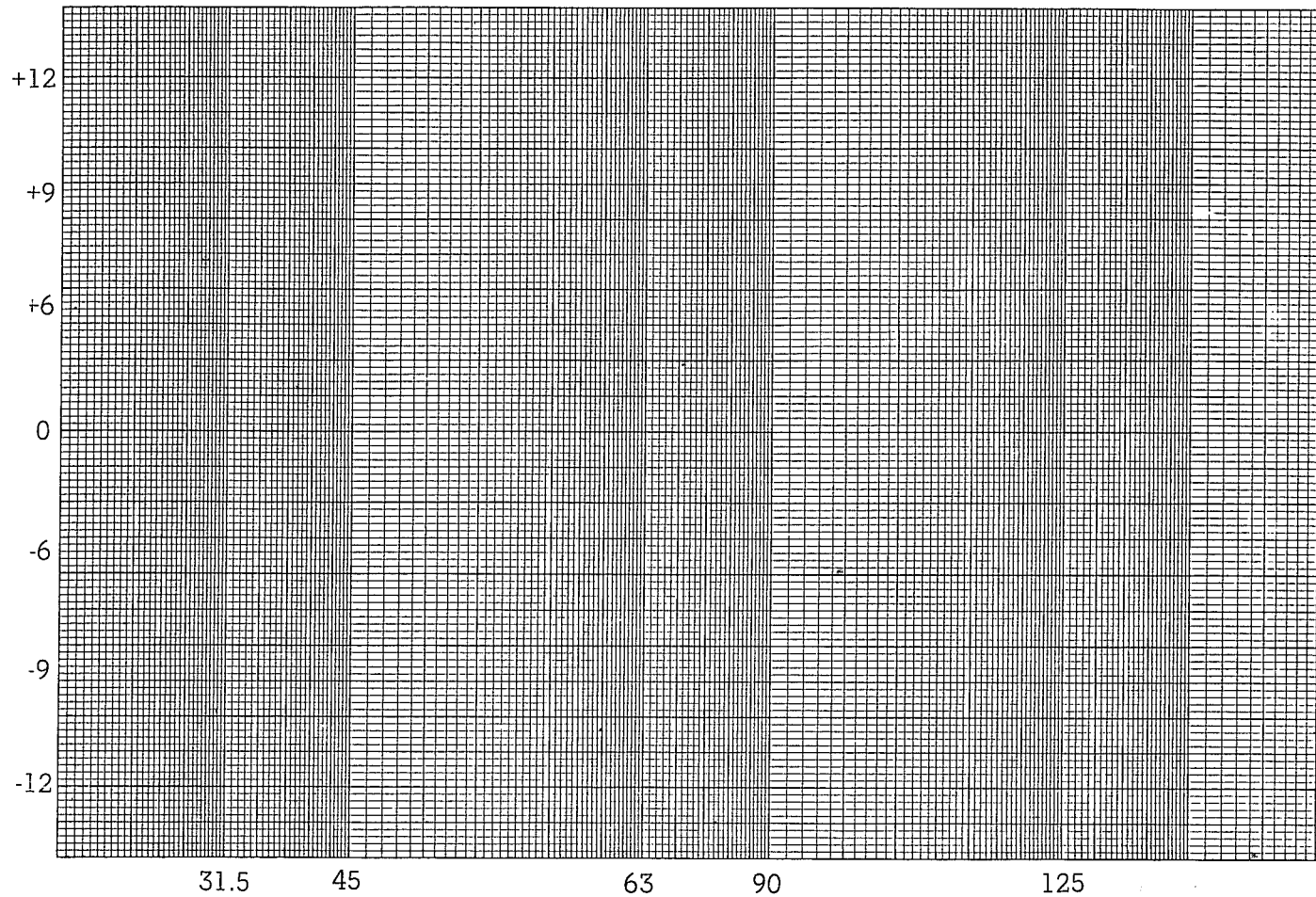

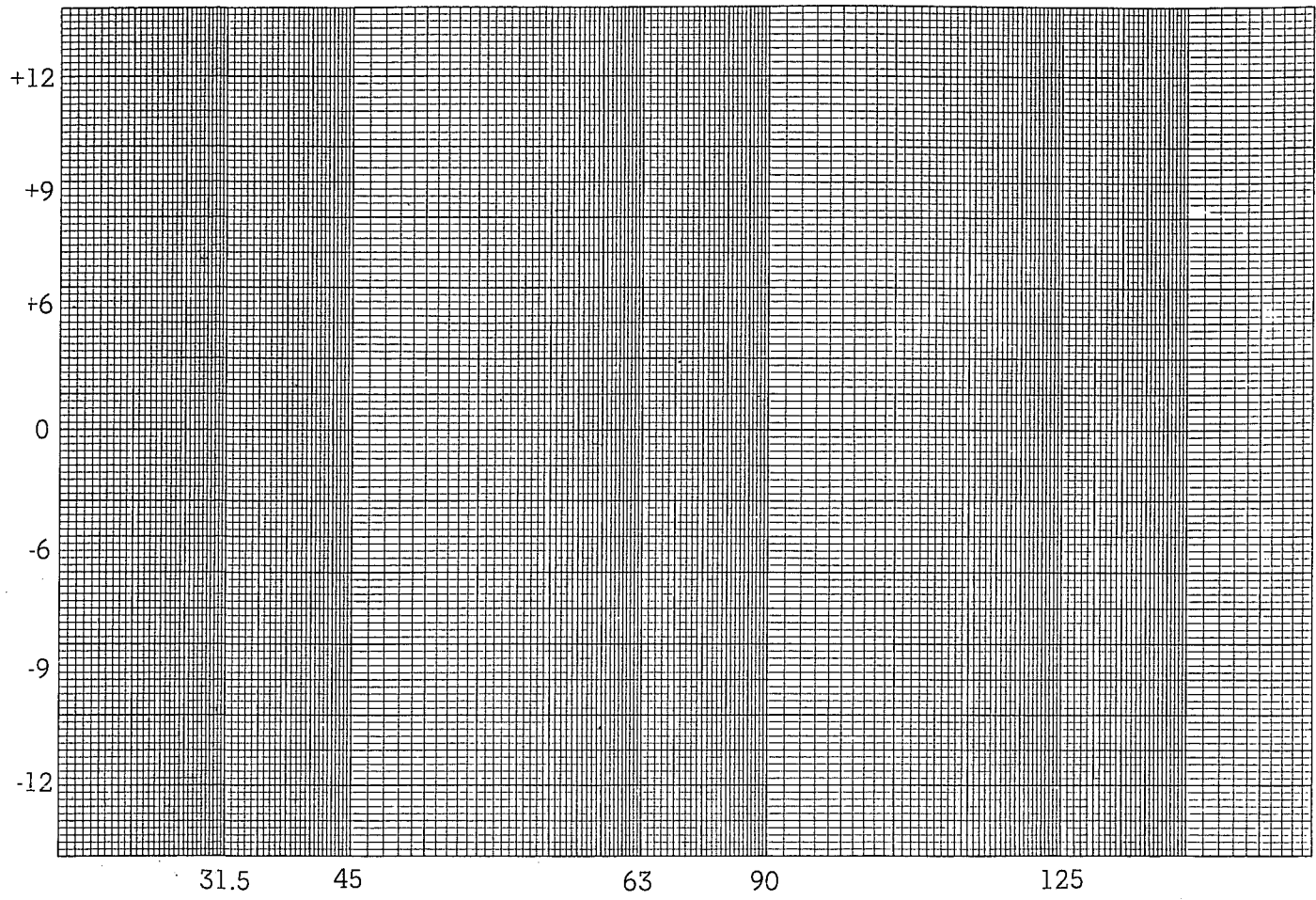

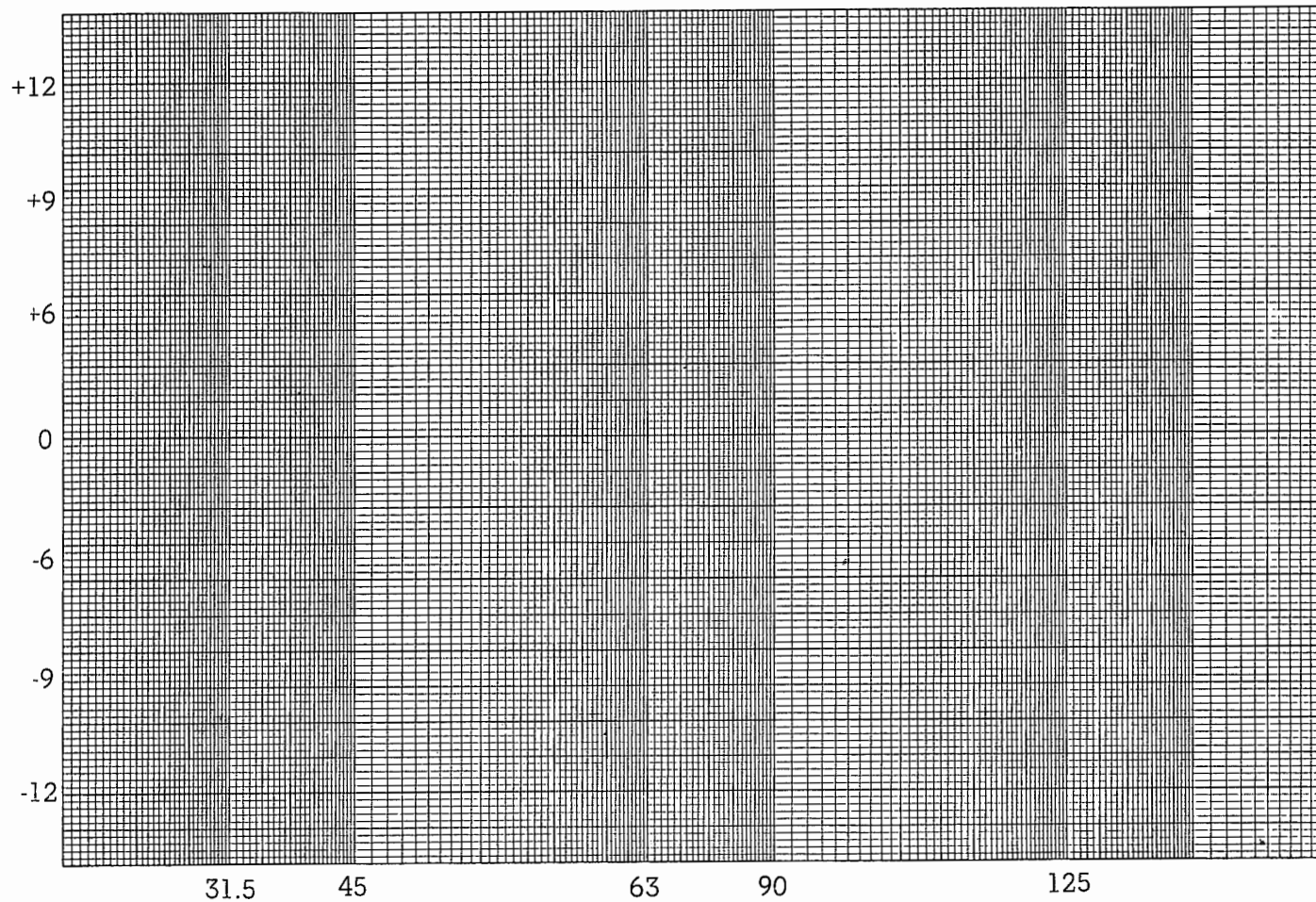

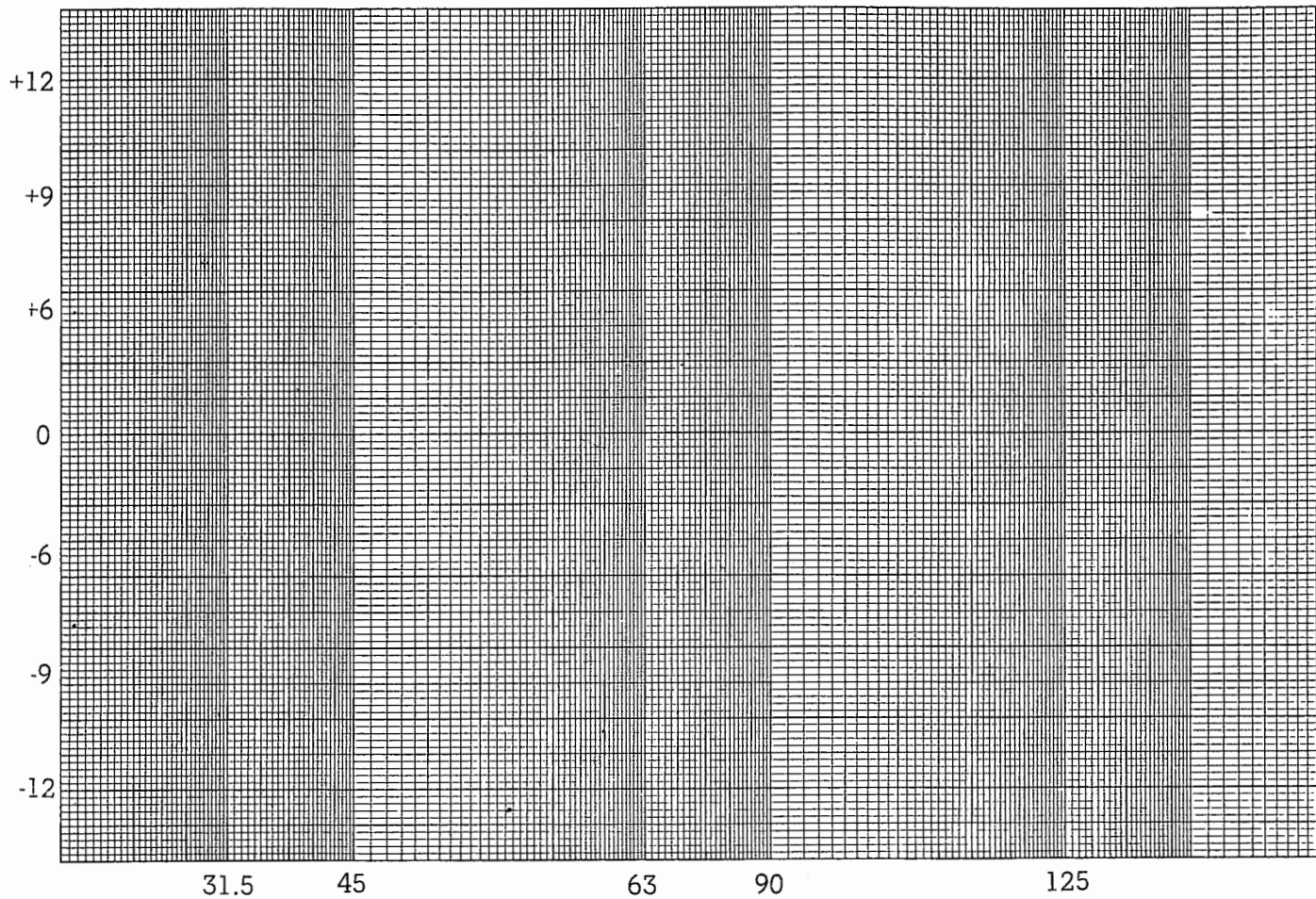



AudioControl

6520 212th S.W. In the Heart of the Northwest Rainforest, Lynnwood, WA 98036 (206) 775-8461